

# USER GUIDE

## **FmX<sup>®</sup> Integrated Display**

Version 6.0  
Revision A  
October 2011



## Agriculture Business Area

Trimble Navigation Limited  
Trimble Agriculture Division  
10355 Westmoor Drive  
Suite #100  
Westminster, CO 80021  
USA

[trimble\\_support@trimble.com](mailto:trimble_support@trimble.com)  
[www.trimble.com](http://www.trimble.com)

## Legal Notices

### Copyright and Trademarks

©2011, Trimble Navigation Limited. All rights reserved.

Trimble, the Globe & Triangle logo, AgGPS, EZ-Guide, EZ-Steer, FmX, and Tru Count are trademarks of Trimble Navigation Limited, registered in the United States and in other countries.

Autopilot, Autoseed, AutoSense, EZ-Office, FieldManager, Field-IQ, FreeForm, VRS, VRS Now, T2, TrueGuide, and TrueTracker are trademarks of Trimble Navigation Limited.

GreenSeeker is a registered trademark of NTech Ltd.

For STL support, the software uses the Moscow Center for SPARC Technology adaptation of the SGI Standard Template Library. Copyright © 1994 Hewlett-Packard Company. Copyright © 1996, 97 Silicon Graphics Computer Systems, Inc., Copyright © 1997 Moscow Center for SPARC Technology.

Microsoft, Windows, ActiveX, Excel, and Internet Explorer are either registered trademarks or trademarks of Microsoft Corporation in the United States and/or other countries.

Portions Copyright © 2009 Nokia Corporation and/or its subsidiary(-ies).

Portions Copyright © 2003, Bitstream Inc.

All other trademarks are the property of their respective owners.

### Release Notice

This is the October 2011 release (Revision A) of the *FmX Integrated Display User Guide*, part number 93023-80-ENG. It applies to version 6.0 of the FmX integrated display software.

### Legal Notices

The following limited warranties give you specific legal rights. You may have others, which vary from state/jurisdiction to state/jurisdiction.

### Product Limited Warranty

Trimble warrants that this Trimble product and its internal components (the "Product") shall be free from defects in materials and workmanship and will substantially conform to Trimble's applicable published specifications for the Product for a period of one (1) year, starting from the earlier of (i) the date of installation, or (ii) six (6) months from the date of original Product shipment from Trimble. This warranty applies only to the Product if installed by Trimble or a dealer authorized by Trimble to perform Product installation services.

### Software Components

All Product software components (sometimes hereinafter also referred to as "Software") are licensed solely for use as an integral part of the Product and are not sold. Any software accompanied by a separate end user license agreement ("EULA") shall be governed by the terms, conditions, restrictions and limited warranty terms of such EULA notwithstanding the preceding paragraph.

During the limited warranty period you will be entitled to receive such Fixes to the Product software that Trimble releases and makes commercially available and for which it does not charge separately, subject to the procedures for delivery to purchasers of Trimble products generally. If you have purchased the Product from an authorized Trimble dealer rather than from Trimble directly, Trimble may, at its option, forward the software Fix to the Trimble dealer for final distribution to you. Minor Updates, Major Upgrades, new products, or substantially new software releases, as identified by Trimble, are expressly excluded from this update process and limited warranty. Receipt of software Fixes or other enhancements shall not serve to extend the limited warranty period.

For purposes of this warranty the following definitions shall apply: (1) "Fix(es)" means an error correction or other update created to fix a previous software version that does not substantially conform to its Trimble specifications; (2) "Minor Update" occurs when enhancements are made to current features in a software program; and (3) "Major Upgrade" occurs when significant new features are added to software, or when a new product containing new features replaces the further development of a current product line. Trimble reserves the right to determine, in its sole discretion, what constitutes a Fix, Minor Update, or Major Upgrade.

This Trimble software contains Qt 4.5 libraries licensed under the GNU Lesser General Public License (LGPL). The source is available from <http://qt.nokia.com/downloads>. A copy of the LGPL license is included in the appendices of this manual, and at [ftp://ftp.trimble.com/pub/open\\_source/FmX](ftp://ftp.trimble.com/pub/open_source/FmX).

This software includes the DejaVu fonts, which are licensed under the Bitstream Vera license, terms available at <http://dejavu-fonts.org/wiki/index.php?title=License> and <http://www.gnome.org/fonts/>.

## GNU LESSER GENERAL PUBLIC LICENSE

Version 2.1, February 1999

Copyright © 1991, 1999 Free Software Foundation, Inc.

51 Franklin Street, Fifth Floor, Boston, MA 02110-1301

USA

Everyone is permitted to copy and distribute verbatim copies of this license document, but changing it is not allowed. [This is the first released version of the Lesser GPL. It also counts as the successor of the GNU Library Public License, version 2, hence the version number 2.1.]

Preamble

The licenses for most software are designed to take away your freedom to share and change it. By contrast, the GNU General Public Licenses are intended to guarantee your freedom to share and change free software-to make sure the software is free for all its users.

This license, the Lesser General Public License, applies to some specially designated software packages-typically libraries-of the Free Software Foundation and other authors who decide to use it. You can use it too, but we suggest you first think carefully about whether this license or the ordinary General Public License is the better strategy to use in any particular case, based on the explanations below.

When we speak of free software, we are referring to freedom of use, not price. Our General Public Licenses are designed to make sure that you have the freedom to distribute copies of free software (and charge for this service if you wish); that you receive source code or can get it if you want it; that you can change the software and use pieces of it in new free programs; and that you are informed that you can do these things.

To protect your rights, we need to make restrictions that forbid distributors to deny you these rights or to ask you to surrender these rights. These restrictions translate to certain responsibilities for you if you distribute copies of the library or if you modify it.

For example, if you distribute copies of the library, whether gratis or for a fee, you must give the recipients all the rights that we gave you. You must make sure that they, too, receive or can get the source code. If you link other code with the library, you must provide complete object files to the recipients, so that they can relink them with the library after making changes to the library and recompiling it. And you must show them these terms so they know their rights.

We protect your rights with a two-step method: (1) we copyright the library, and (2) we offer you this license, which gives you legal permission to copy, distribute and/ or modify the library.

To protect each distributor, we want to make it very clear that there is no warranty for the free library. Also, if the library is modified by someone else and passed on, the recipients should know that what they have is not the original version, so that the original author's reputation will not be affected by problems that might be introduced by others.

Finally, software patents pose a constant threat to the existence of any free program. We wish to make sure that a company cannot effectively restrict the users of a free program by obtaining a restrictive license from a patent holder. Therefore, we insist that any patent license obtained for a version of the library must be consistent with the full freedom of use specified in this license.

Most GNU software, including some libraries, is covered by the ordinary GNU General Public License. This license, the GNU Lesser General Public License, applies to certain designated libraries, and is quite different from the ordinary General Public License. We use this license for certain libraries in order to permit linking those libraries into non-free programs.

When a program is linked with a library, whether statically or using a shared library, the combination of the two is legally speaking a combined work, a derivative of the original library. The ordinary General Public License therefore permits such linking only if the entire combination fits its criteria of freedom. The Lesser General Public License permits more lax criteria for linking other code with the library.

We call this license the "Lesser" General Public License because it does Less to protect the user's freedom than the ordinary General Public License. It also provides other free software developers Less of an advantage over competing non-free programs. These disadvantages are the reason we use the ordinary General Public License for many libraries. However, the Lesser license provides advantages in certain special circumstances.

For example, on rare occasions, there may be a special need to encourage the widest possible use of a certain library, so that it becomes a de-facto standard. To achieve this, non-free programs must be allowed to use the library. A more frequent case is that a free library does the same job as widely used non-free libraries. In this case, there is little to gain by limiting the free library to free software only, so we use the Lesser General Public License.

In other cases, permission to use a particular library in nonfree programs enables a greater number of people to use a large body of free software. For example, permission to use the GNU C Library in non-free programs enables many more people to use the whole GNU operating system, as well as its variant, the GNU/Linux operating system.

Although the Lesser General Public License is Less protective of the users' freedom, it does ensure that the user of a program that is linked with the Library has the freedom and the wherewithal to run that program using a modified version of the Library.

The precise terms and conditions for copying, distribution and modification follow. Pay close attention to the difference between a "work based on the library" and a "work that uses the library". The former contains code derived from the library, whereas the latter must be combined with the library in order to run.

#### GNU LESSER GENERAL PUBLIC LICENSE

#### TERMS AND CONDITIONS FOR COPYING, DISTRIBUTION AND MODIFICATION

0. This License Agreement applies to any software library or other program which contains a notice placed by the copyright holder or other authorized party saying it may be distributed under the terms of this Lesser General Public License (also called "this License"). Each licensee is addressed as "you". A "library" means a collection of software functions and/or data prepared so as to be conveniently linked with application programs (which use some of those functions and data) to form executables.

The "Library", below, refers to any such software library or work which has been distributed under these terms. A "work based on the Library" means either the Library or any derivative work under copyright law; that is to say, a work containing the Library or a portion of it, either verbatim or with modifications and/or translated straightforwardly into another language. (Hereinafter, translation is included without limitation in the term "modification".)

"Source code" for a work means the preferred form of the work for making modifications to it. For a library, complete source code means all the source code for all modules it contains, plus any associated interface definition files, plus the scripts used to control compilation and installation of the library.

Activities other than copying, distribution and modification are not covered by this License; they are outside its scope. The act of running a program using the Library is not restricted, and output from such a program is covered only if its contents constitute a work based on the Library (independent of the use of the Library in a tool for writing it). Whether that is true depends on what the Library does and what the program that uses the Library does.

1. You may copy and distribute verbatim copies of the Library's complete source code as you receive it, in any medium, provided that you conspicuously and appropriately publish on each copy an appropriate copyright notice and disclaimer of warranty; keep intact all the notices that refer to this License and to the absence of any warranty; and distribute a copy of this License along with the Library.

You may charge a fee for the physical act of transferring a copy, and you may at your option offer warranty protection in exchange for a fee.

2. You may modify your copy or copies of the Library or any portion of it, thus forming a work based on the Library, and copy and distribute such modifications or work under the terms of Section 1 above, provided that you also meet all of these conditions:

- The modified work must itself be a software library.
- You must cause the files modified to carry prominent notices stating that you changed the files and the date of any change.
- You must cause the whole of the work to be licensed at no charge to all third parties under the terms of this License.
- If a facility in the modified Library refers to a function or a table of data to be supplied by an application program that uses the facility, other than as an argument passed when the facility is invoked, then you must make a good faith effort to ensure that, in the event an application does not supply such function or table, the facility still operates, and performs whatever part of its purpose remains meaningful.

(For example, a function in a library to compute square roots has a purpose that is entirely well-defined independent of the application. Therefore, Subsection 2d requires that any application-supplied function or table used by this function must be optional: if the application does not supply it, the square root function must still compute square roots.)

These requirements apply to the modified work as a whole. If identifiable sections of that work are not derived from the Library, and can be reasonably considered independent and separate works in themselves, then this License, and its terms, do not apply to those sections when you distribute them as separate works. But when you distribute the same sections as part of a whole which is a work based on the Library, the distribution of the whole must be on the terms of this License, whose permissions for other licensees extend to the entire whole, and thus to each and every part regardless of who wrote it.

Thus, it is not the intent of this section to claim rights or contest your rights to work written entirely by you; rather, the intent is to exercise the right to control the distribution of derivative or collective works based on the Library.

In addition, mere aggregation of another work not based on the Library with the Library (or with a work based on the Library) on a volume of a storage or distribution medium does not bring the other work under the scope of this License.

3. You may opt to apply the terms of the ordinary GNU General Public License instead of this License to a given copy of the Library. To do this, you must alter all the notices that refer to this License, so that they refer to the ordinary GNU General Public License, version 2, instead of to this License. (If a newer version than version 2 of the ordinary GNU General Public License has appeared, then you can specify that version instead if you wish.) Do not make any other change in these notices.

Once this change is made in a given copy, it is irreversible for that copy, so the ordinary GNU General Public License applies to all subsequent copies and derivative works made from that copy.

This option is useful when you wish to copy part of the code of the Library into a program that is not a library.

4. You may copy and distribute the Library (or a portion or derivative of it, under Section 2) in object code or executable form under the terms of Sections 1 and 2 above provided that you accompany it with the complete corresponding machine-readable source code, which must be distributed under the terms of Sections 1 and 2 above on a medium customarily used for software interchange.

If distribution of object code is made by offering access to copy from a designated place, then offering equivalent access to copy the source code from the same place satisfies the requirement to distribute the source code, even though third parties are not compelled to copy the source along with the object code.

5. A program that contains no derivative of any portion of the Library, but is designed to work with the Library by being compiled or linked with it, is called a "work that uses the Library". Such a work, in isolation, is not a derivative work of the Library, and therefore falls outside the scope of this License.

However, linking a "work that uses the Library" with the Library creates an executable that is a derivative of the Library (because it contains portions of the Library), rather than a "work that uses the library". The executable is therefore covered by this License. Section 6 states terms for distribution of such executables.

When a "work that uses the Library" uses material from a header file that is part of the Library, the object code for the work may be a derivative work of the Library even though the source code is not. Whether this is true is especially significant if the work can be linked without the Library, or if the work is itself a library. The threshold for this to be true is not precisely defined by law.

If such an object file uses only numerical parameters, data structure layouts and accessors, and small macros and small inline functions (ten lines or less in length), then the use of the object file is unrestricted, regardless of whether it is legally a derivative work. (Executables containing this object code plus portions of the Library will still fall under Section 6.)

Otherwise, if the work is a derivative of the Library, you may distribute the object code for the work under the terms of Section 6. Any executables containing that work also fall under Section 6, whether or not they are linked directly with the Library itself.

6. As an exception to the Sections above, you may also combine or link a "work that uses the Library" with the Library to produce a work containing portions of the Library, and distribute that work under terms of your choice, provided that the terms permit modification of the work for the customer's own use and reverse engineering for debugging such modifications.

You must give prominent notice with each copy of the work that the Library is used in it and that the Library and its use are covered by this License. You must supply a copy of this License. If the work during execution displays copyright notices, you must include the copyright notice for the Library among them, as well as a reference directing the user to the copy of this License. Also, you must do one of these things:

- Accompany the work with the complete corresponding machine-readable source code for the Library including whatever changes were used in the work (which must be distributed under Sections 1 and 2 above); and, if the work is an executable linked with the Library, with the complete machine-readable "work that uses the Library", as object code and/or source code, so that the user can modify the Library and then relink to produce a modified executable containing the modified Library. (It is understood that the user who changes the contents of definitions files in the Library will not necessarily be able to recompile the application to use the modified definitions.)
- Use a suitable shared library mechanism for linking with the Library. A suitable mechanism is one that (1) uses at run time a copy of the library already present on the user's computer system, rather than copying library functions into the executable, and (2) will operate properly with a modified version of the library, if the user installs one, as long as the modified version is interface-compatible with the version that the work was made with.
- Accompany the work with a written offer, valid for at least three years, to give the same user the materials specified in Subsection 6a, above, for a charge no more than the cost of performing this distribution.
- If distribution of the work is made by offering access to copy from a designated place, offer equivalent access to copy the above specified materials from the same place.
- Verify that the user has already received a copy of these materials or that you have already sent this user a copy.

For an executable, the required form of the "work that uses the Library" must include any data and utility programs needed for reproducing the executable from it. However, as a special exception, the materials to be distributed need not include anything that is normally distributed (in either source or binary form) with the major components (compiler, kernel, and so on) of the operating system on which the executable runs, unless that component itself accompanies the executable.

It may happen that this requirement contradicts the license restrictions of other proprietary libraries that do not normally accompany the operating system. Such a contradiction means you cannot use both them and the Library together in an executable that you distribute.

7. You may place library facilities that are a work based on the Library side-by-side in a single library together with other library facilities not covered by this License, and distribute such a combined library, provided that the separate distribution of the work based on the Library and of the other library facilities is otherwise permitted, and provided that you do these two things:

- a) Accompany the combined library with a copy of the same work based on the Library, uncombined with any other library facilities. This must be distributed under the terms of the Sections above.
- b) Give prominent notice with the combined library of the fact that part of it is a work based on the Library, and explaining where to find the accompanying uncombined form of the same work.
8. You may not copy, modify, sublicense, link with, or distribute the Library except as expressly provided under this License. Any attempt otherwise to copy, modify, sublicense, link with, or distribute the Library is void, and will automatically terminate your rights under this License. However, parties who have received copies, or rights, from you under this License will not have their licenses terminated so long as such parties remain in full compliance.
9. You are not required to accept this License, since you have not signed it. However, nothing else grants you permission to modify or distribute the Library or its derivative works. These actions are prohibited by law if you do not accept this License. Therefore, by modifying or distributing the Library (or any work based on the Library), you indicate your acceptance of this License to do so, and all its terms and conditions for copying, distributing or modifying the Library or works based on it.
10. Each time you redistribute the Library (or any work based on the Library), the recipient automatically receives a license from the original licensor to copy, distribute, link with or modify the Library subject to these terms and conditions. You may not impose any further restrictions on the recipients' exercise of the rights granted herein. You are not responsible for enforcing compliance by third parties with this License.

#### Warranty Remedies

Trimble's sole liability and your exclusive remedy under the warranties set forth above shall be, at Trimble's option, to repair or replace any Product that fails to conform to such warranty ("Nonconforming Product"), and/or issue a cash refund up to the purchase price paid by you for any such Nonconforming Product, excluding costs of installation, upon your return of the Nonconforming Product to Trimble in accordance with Trimble's product return procedures than in effect. Such remedy may include reimbursement of the cost of repairs for damage to third-party equipment onto which the Product is installed, if such damage is found to be directly caused by the Product as reasonably determined by Trimble following a root cause analysis.

#### Warranty Exclusions and Disclaimer

These warranties shall be applied only in the event and to the extent that (a) the Products and Software are properly and correctly installed, configured, interfaced, maintained, stored, and operated in accordance with Trimble's relevant operator's manual and specifications, and; (b) the Products and Software are not modified or misused. The preceding warranties shall not apply to, and Trimble shall not be responsible for defects or performance problems resulting from (i) the combination or utilization of the Product or Software with hardware or software products, information, data, systems, interfaces or devices not made, supplied or specified by Trimble; (ii) the operation of the Product or Software under any specification other than, or in addition to, Trimble's standard specifications for its products; (iii) the unauthorized, installation, modification, or use of the Product or Software; (iv) damage caused by accident, lightning or other electrical discharge, fresh or salt water immersion or spray (outside of Product specifications); or (v) normal wear and tear on consumable parts (e.g., batteries). Trimble does not warrant or guarantee the results obtained through the use of the Product or that software components will operate error free.

THE WARRANTIES ABOVE STATE TRIMBLE'S ENTIRE LIABILITY, AND YOUR EXCLUSIVE REMEDIES, RELATING TO THE PRODUCTS AND SOFTWARE. EXCEPT AS OTHERWISE EXPRESSLY PROVIDED HEREIN, THE PRODUCTS, SOFTWARE, AND ACCOMPANYING DOCUMENTATION AND MATERIALS ARE PROVIDED "AS-IS" AND WITHOUT EXPRESS OR IMPLIED WARRANTY OF ANY KIND BY EITHER TRIMBLE NAVIGATION LIMITED OR ANYONE WHO HAS BEEN INVOLVED IN ITS CREATION, PRODUCTION, INSTALLATION, OR DISTRIBUTION INCLUDING, BUT NOT LIMITED TO, THE IMPLIED WARRANTIES OF MERCHANTABILITY AND FITNESS FOR A PARTICULAR PURPOSE, TITLE, AND NON-INFRINGEMENT. THE STATED EXPRESS WARRANTIES ARE IN LIEU OF ALL OBLIGATIONS OR LIABILITIES ON THE PART OF TRIMBLE ARISING OUT OF, OR IN CONNECTION WITH, ANY PRODUCTS OR SOFTWARE. BECAUSE SOME STATES AND JURISDICTIONS DO NOT ALLOW LIMITATIONS ON DURATION OR THE EXCLUSION OF AN IMPLIED WARRANTY, THE ABOVE LIMITATION MAY NOT APPLY OR FULLY APPLY TO YOU.

**NOTICE REGARDING PRODUCTS EQUIPPED WITH TECHNOLOGY CAPABLE OF TRACKING SATELLITE SIGNALS FROM SATELLITE BASED AUGMENTATION SYSTEMS (SBAS) (WAAS/EGNOS, AND MSAS), OMNISTAR, GPS, MODERNIZED GPS OR GLONASS SATELLITES, OR FROM IALA BEACON SOURCES: TRIMBLE IS NOT RESPONSIBLE FOR THE OPERATION OR FAILURE OF OPERATION OF ANY SATELLITE BASED POSITIONING SYSTEM, OR THE AVAILABILITY OF ANY SATELLITE BASED POSITIONING SIGNALS.**

#### Limitation of Liability

TRIMBLE'S ENTIRE LIABILITY UNDER ANY PROVISION HEREIN SHALL BE LIMITED TO THE AMOUNT PAID BY YOU FOR THE PRODUCT OR SOFTWARE LICENSE. TO THE MAXIMUM EXTENT PERMITTED BY APPLICABLE LAW, IN NO EVENT SHALL TRIMBLE OR ITS SUPPLIERS BE LIABLE FOR ANY INDIRECT, SPECIAL, INCIDENTAL OR CONSEQUENTIAL DAMAGES WHATSOEVER UNDER ANY CIRCUMSTANCE OR LEGAL THEORY RELATING IN ANY WAY TO THE PRODUCTS, SOFTWARE AND ACCOMPANYING DOCUMENTATION AND MATERIALS, (INCLUDING, WITHOUT LIMITATION, DAMAGES FOR LOSS OF BUSINESS PROFITS, BUSINESS INTERRUPTION, LOSS OF BUSINESS INFORMATION, OR ANY OTHER PECUNIARY LOSS), REGARDLESS WHETHER TRIMBLE HAS BEEN ADVISED OF THE POSSIBILITY OF ANY SUCH LOSS AND REGARDLESS OF THE COURSE OF DEALING WHICH DEVELOPS OR HAS

DEVELOPED BETWEEN YOU AND TRIMBLE. BECAUSE SOME STATES AND JURISDICTIONS DO NOT ALLOW THE EXCLUSION OR LIMITATION OF LIABILITY FOR CONSEQUENTIAL OR INCIDENTAL DAMAGES, THE ABOVE LIMITATION MAY NOT APPLY OR FULLY APPLY TO YOU.

**PLEASE NOTE: THE ABOVE TRIMBLE LIMITED WARRANTY PROVISIONS WILL NOT APPLY TO PRODUCTS PURCHASED IN THOSE JURISDICTIONS (E.G., MEMBER STATES OF THE EUROPEAN ECONOMIC AREA) IN WHICH PRODUCT WARRANTIES ARE THE RESPONSIBILITY OF THE LOCAL DEALER FROM WHOM THE PRODUCTS ARE ACQUIRED. IN SUCH A CASE, PLEASE CONTACT YOUR TRIMBLE DEALER FOR APPLICABLE WARRANTY INFORMATION.**

#### Official Language

THE OFFICIAL LANGUAGE OF THESE TERMS AND CONDITIONS IS ENGLISH. IN THE EVENT OF A CONFLICT BETWEEN ENGLISH AND OTHER LANGUAGE VERSIONS, THE ENGLISH LANGUAGE SHALL CONTROL.

#### Registration

TO RECEIVE INFORMATION REGARDING UPDATES AND NEW PRODUCTS, PLEASE CONTACT YOUR LOCAL DEALER OR VISIT THE TRIMBLE WEBSITE AT [www.trimble.com/register](http://www.trimble.com/register). UPON REGISTRATION YOU MAY SELECT THE NEWSLETTER, UPGRADE, OR NEW PRODUCT INFORMATION YOU DESIRE.

#### Registration

To receive information regarding updates and new products, please contact your local dealer or visit the Trimble website at [www.trimble.com/register](http://www.trimble.com/register). Upon registration you may select the newsletter, upgrade or new product information you desire.

#### Notices

This equipment has been tested and found to comply with the limits for a Class A digital device, pursuant to Part 15 of the FCC rules. These limits are designed to provide reasonable protection against harmful interference when the equipment is operated in a commercial environment. This equipment generates, uses, and can radiate radio frequency energy and, if not installed and used in accordance with the instruction manual, may cause harmful interference to radio communications. Operation of this equipment in a residential area is likely to cause harmful interference, in which case the user will be required to correct the interference at his own expense.

Properly shielded and grounded cables and connectors must be used in order to meet FCC emission limits. TRIMBLE is not responsible for any radio or television interference caused by using other than recommended cables and connectors or by unauthorized changes or modifications to this equipment. Unauthorized changes or modifications could void the user's authority to operate the equipment.

This device complies with Part 15 of the FCC rules. Operation is subject to the following two conditions:

- (1) this device may not cause harmful interference, and (2) this device must accept any interference received, including interference that may cause undesired operation.

Responsible Party:

Trimble Navigation  
935 Stewart Drive  
Sunnyvale CA 94085  
Telephone: 1-408 481 8000

#### Canada

This Class B digital apparatus complies with Canadian ICES-003.

Cet appareil numérique de la classe B est conforme à la norme NMB-003 du Canada.

This apparatus complies with Canadian RSS-GEN, RSS-310, RSS-210, and RSS-119.

Cet appareil est conforme à la norme CNR-GEN, CNR-310, CNR-210, et CNR-119 du Canada.

#### Australia and New Zealand Class A Statement

Attention: This is a Class A product. In a domestic environment this product may cause radio interference in which case the user may be required to take adequate measures.

#### Australia and New Zealand

This product conforms with the regulatory requirements of the Australian Communications Authority (ACA) EMC framework, thus satisfying the requirements for C-Tick Marking and sale within Australia and New Zealand.



#### Notice to Our European Union Customers

For product recycling instructions and more information, please go to [www.trimble.com/ev.shtml](http://www.trimble.com/ev.shtml).

Recycling in Europe: To recycle Trimble WEEE (Waste Electrical and Electronic Equipment, products that run on electrical power), Call +31 497 53 24 30, and ask for the "WEEE Associate". Or, mail a request for recycling instructions to:  
Trimble Europe BV  
c/o Menlo Worldwide Logistics  
Meerheide 45  
5521 DZ Eersel, NL





# Safety

Always follow the instructions that accompany a Warning or Caution. The information they provide is intended to minimize the risk of personal injury and/or damage to property. In particular, observe safety instructions that are presented in the following format:



---

**WARNING** – This alert warns of a potential hazard which, if not avoided, can cause severe injury.

---



---

**CAUTION** – This alert warns of a hazard or unsafe practice which, if not avoided, can cause injury or damage.

---

*Note* – An absence of specific alerts does not mean that there are no safety risks involved.

## Warnings



---

**WARNING** – Incorrect adjustment of the Manual Override Sensitivity calibration setting could cause this critical safety feature to fail, resulting in personal injury or damage to the vehicle. Any adjustment to this setting should only be made by an experienced user.

---



---

**WARNING** – During the Deadzone calibration, the system moves the vehicle's steering wheels. To avoid injury, be prepared for sudden vehicle movement.

---



---

**WARNING** – When you tap the liquid flow calibration **Start** button, the machine will become operational. Take all necessary precautions to ensure user safety. Failure to do so may result in serious injury or death.

---



---

**WARNING** – When you tap the control valve calibration **Start** button, the machine will become operational. Take all necessary precautions to ensure user safety. Failure to do so may result in serious injury or death.

---



---

**WARNING** – When you tap the fill disk **Start** button, the machine will become operational. Take all necessary precautions to ensure user safety. Failure to do so may result in serious injury or death.

---



---

**WARNING** – When the implement is down and the master switch is in the On position, the machine is fully operational. Take all necessary precautions to ensure user safety. Failure to do so could result in injury or death.

---



---

**WARNING** – The display contains a single-use Lithium-sulfide LiSO<sup>2</sup> battery. Do not expose the battery to temperatures greater than 71 °C (160 °F) as the battery may explode.

---



---

**WARNING** –  $\text{NH}_3$  is an irritant and corrosive to the skin, eyes, respiratory tract and mucous membranes, and is dangerous if not handled properly. It may cause severe burns to the eyes, lungs, and skin. Skin, and respiratory-related diseases could be aggravated by exposure. It is recommended that protective gloves, boots, slicker and/or pants and jacket, and chemical-splash goggles that are impervious to anhydrous ammonia are worn at all times.

---



---

**WARNING** – The anhydrous valve calibration requires the vehicle and implement to be moving and the implement must be in the ground (the implement lift switch must be down). Take all necessary precautions to ensure user safety. Failure to do so may result in serious injury or death.

---

# Contents

<b>Safety</b> . . . . .	<b>5</b>
Warnings . . . . .	5
<b>1 Introduction</b> . . . . .	<b>17</b>
About the product . . . . .	17
Using this manual. . . . .	17
Related information . . . . .	17
Technical assistance . . . . .	17
Your comments . . . . .	18
<b>2 Display Overview</b> . . . . .	<b>19</b>
System components . . . . .	20
Pack-out contents . . . . .	20
Front view . . . . .	21
Rear view . . . . .	22
System software. . . . .	23
Control buttons. . . . .	24
Touch screen elements . . . . .	24
Folder hierarchy. . . . .	27
Using the FmX integrated display. . . . .	28
Turning on the display . . . . .	28
Turning off the display . . . . .	28
Home screen. . . . .	29
Configuration screen . . . . .	30
Run screen . . . . .	31
Zoom and Pan functions . . . . .	32
Context-sensitive help. . . . .	34
Installing the display . . . . .	35
Connecting the display . . . . .	37
Inserting a memory stick into the USB socket . . . . .	37
External lightbar/s . . . . .	38
<b>3 Getting Started.</b> . . . . .	<b>39</b>
Introduction to field features. . . . .	40
Starting a field . . . . .	41
Creating a client. . . . .	42
Additional settings . . . . .	42
Closing a field . . . . .	44
Saving an event summary . . . . .	44
The Run screen layout . . . . .	45
Selecting a swath pattern. . . . .	51
Creating a new line. . . . .	53
The Record button . . . . .	55

Creating guidance with the FreeForm pattern. . . . .	56
Loading a line . . . . .	59
Adding an access path. . . . .	59
Swath management . . . . .	60
Using the “Guide to” tabs . . . . .	62
Using Skip to fine-tune navigation . . . . .	62
Placing field features on screen . . . . .	63
Pausing guidance. . . . .	64
Adjusting the status text size . . . . .	64
Introduction to coverage logging . . . . .	65
Logging varieties . . . . .	65
Prescriptions . . . . .	67
<b>4 Display Setup. . . . .</b>	<b>71</b>
Accessing the system configuration settings . . . . .	72
Password access . . . . .	73
Configuring the display . . . . .	73
Data Files. . . . .	74
Map Settings (including night-mode) . . . . .	74
Status items . . . . .	77
Selecting the language, units of measure, and keyboard layout . . . . .	88
Default settings . . . . .	89
Feature mapping . . . . .	89
Data Dictionary. . . . .	95
Lightbar. . . . .	96
EZ-Remote joystick . . . . .	97
Guidance . . . . .	97
Sounds . . . . .	98
CAN bus settings . . . . .	99
Power management . . . . .	100
Time zone . . . . .	101
Signal input module for an OEM switch interface . . . . .	101
<b>5 Vehicle Guidance Options. . . . .</b>	<b>103</b>
Manual guidance . . . . .	104
Configuring the GPS receiver . . . . .	105
Run screen for manual guidance . . . . .	105
Autopilot automated steering system guidance . . . . .	106
Configuring the Vehicle tab . . . . .	106
Configuring the Engage tab . . . . .	107
Configuring the Steering tab. . . . .	107
Configuring the Advanced tab. . . . .	109
Selecting the vehicle . . . . .	109
Autopilot calibration. . . . .	111
Common calibration items. . . . .	111
Calibrating the Autopilot option . . . . .	112
Configuring the controller orientation . . . . .	113

Configuring the manual override sensitivity . . . . .	114
Calibrating the AutoSense device. . . . .	116
Calibrating the steering angle sensor . . . . .	116
Calibrating the automated steering deadzone. . . . .	119
Calibrating the proportional steering gain . . . . .	121
Configuring the antenna position and roll offset correction . . . . .	124
Calibrating the line acquisition aggressiveness . . . . .	128
Calibrating a tracked tractor. . . . .	129
Tracked vehicle steering wheel calibration. . . . .	132
Saving a vehicle profile . . . . .	132
Configuring the GPS receiver . . . . .	134
Adjusting the Aggressiveness setting . . . . .	134
Display-only mode . . . . .	134
Connecting the FmX integrated display for display-only mode . . . . .	135
Row Guidance . . . . .	137
Configuring the Row Guidance plugin on the FmX display . . . . .	138
Row-Guidance Diagnostics screen. . . . .	139
Operating the Row Guidance plugin. . . . .	140
Connecting the system . . . . .	142
EZ-Pilot assisted steering system guidance. . . . .	143
Installing the EZ-Pilot system . . . . .	143
Connecting the EZ-Pilot system . . . . .	144
Setup. . . . .	145
Calibrating and configuring the EZ-Pilot system . . . . .	148
EZ-Pilot plugin diagnostics . . . . .	154
Operating the EZ-Pilot system with the FmX integrated display . . . . .	155
EZ-Pilot plugin screen. . . . .	156
Vehicle-specific performance . . . . .	157
After using the EZ-Pilot system. . . . .	157
EZ-Steer assisted steering system guidance . . . . .	158
Installing the EZ-Steer controller. . . . .	158
Connecting the EZ-Steer system . . . . .	158
Calibrating and configuring the EZ-Steer system. . . . .	159
Operating the EZ-Steer system with the FmX integrated display. . . . .	166
Engage options . . . . .	166
Engaging the system. . . . .	167
Disengaging the system. . . . .	167
EZ-Steer plugin screen . . . . .	168
Vehicle-specific performance . . . . .	168
After using the EZ-Steer system. . . . .	169
<b>6 The GPS Receiver. . . . .</b>	<b>171</b>
Configuring the GPS receiver. . . . .	172
Entering 450 MHz frequencies . . . . .	173
Enabling SecureRTK. . . . .	174
Autoseed fast restart technology . . . . .	175
Configuring a GPS receiver with the AgRemote software . . . . .	176



Enabling NMEA message output . . . . .	176
Enabling radar output . . . . .	177
Configuring radar output . . . . .	178
<b>7 Implement Configuration . . . . .</b>	<b>181</b>
Introduction . . . . .	182
Creating an implement . . . . .	182
Selecting an existing implement. . . . .	183
Importing an implement from the FieldManager display . . . . .	183
Adjusting the implement settings. . . . .	184
Implement Type . . . . .	184
Measurements. . . . .	185
Geometry. . . . .	186
Overlap . . . . .	187
Switches . . . . .	187
Deleting an implement . . . . .	188
<b>8 Overview of Plugins . . . . .</b>	<b>189</b>
Introduction to plugins . . . . .	190
Viewing the currently installed plugins . . . . .	191
Adding or removing a plugin . . . . .	192
Configuring a plugin . . . . .	193
Entering the password to activate a plugin . . . . .	193
<b>9 Water Management . . . . .</b>	<b>197</b>
WM-Survey plugin . . . . .	198
Description. . . . .	198
Terminology . . . . .	198
Benefits of the Water Management system . . . . .	199
Installation. . . . .	199
Configuration . . . . .	200
Operating the WM-Survey plugin . . . . .	202
Creating a survey. . . . .	202
Field design . . . . .	208
FieldLevel II plugin . . . . .	211
Leveling models. . . . .	211
Terminology . . . . .	212
Configuring the FieldLevel II plugin . . . . .	212
Operating the FieldLevel II plugin . . . . .	219
Importing control files from the Multiplane software . . . . .	223
Working with MultiPlane designs . . . . .	224
Leveling model specific information. . . . .	225
Driving in Point and Slope mode . . . . .	226
Driving in Flat Plane (Laser) and Flat Plane (GPS) modes . . . . .	227
Defining a plane. . . . .	228
Driving in Contour mode. . . . .	233

Tandem / Dual plugin . . . . .	.234
Configuring the Tandem/Dual plugin . . . . .	.235
Operating the Tandem/Dual plugin . . . . .	.239
WM-Drain plugin . . . . .	.241
Configuring the WM-Drain plugin . . . . .	.241
Surveying a section line . . . . .	.247
Installing a section line . . . . .	.251
<b>10 The Field-IQ Plugin . . . . .</b>	<b>253</b>
Introduction . . . . .	.254
Definitions . . . . .	.254
Units of measure . . . . .	.255
Installing the Field-IQ hardware . . . . .	.255
Field-IQ master switch box functions . . . . .	.256
Field-IQ 12-section switch box (optional) . . . . .	.257
Field-IQ Run screen . . . . .	.257
General setup information . . . . .	.260
The Field-IQ Setup Wizard . . . . .	.260
Linking materials . . . . .	.261
Setting up the Field-IQ system for Planting . . . . .	.263
Material tab . . . . .	.263
Layout tab . . . . .	.265
Section Control tab . . . . .	.266
Rate Control tab . . . . .	.268
Row Monitoring tab . . . . .	.271
Sensors tab . . . . .	.272
Operation tab . . . . .	.273
Material Setup Complete screen . . . . .	.273
Calibrating the implement lift switch . . . . .	.274
Calibrating the Rawson modules . . . . .	.274
Calibrating the PWM valves . . . . .	.278
Operating in the field . . . . .	.281
Setting up the Field-IQ system for Air Seeding . . . . .	.281
Material tab . . . . .	.282
Layout tab . . . . .	.284
Section Control tab . . . . .	.285
Rate Control tab . . . . .	.287
Row Monitoring tab . . . . .	.290
Sensors tab . . . . .	.291
Operation tab . . . . .	.292
Material Setup Complete screen . . . . .	.292
Calibrating the implement lift switch . . . . .	.293
Calibrating the modules . . . . .	.293
Operating in the field . . . . .	.294
Setting up the Field-IQ system for Spraying . . . . .	.294
Material tab . . . . .	.295

Layout tab . . . . .	296
Section Control tab . . . . .	297
Rate Control tab . . . . .	299
Sensors tab. . . . .	302
Operation tab . . . . .	303
Material Setup Complete screen . . . . .	303
Calibrating the implement lift switch . . . . .	304
Calibrating the spraying modules. . . . .	304
Operating in the field . . . . .	307
Setting up the Field-IQ system for Spreading. . . . .	307
Material tab . . . . .	308
Layout tab . . . . .	309
Section Control tab . . . . .	310
Rate Control tab . . . . .	312
Sensors tab. . . . .	317
Operation tab . . . . .	318
Material Setup Complete screen . . . . .	319
Calibrating the implement lift switch . . . . .	319
Calibrating the Rawson modules for spreading . . . . .	319
Calibrating the PWM valves . . . . .	323
Operating in the field . . . . .	328
Setting up the Field-IQ system for Anhydrous . . . . .	329
Material tab . . . . .	329
Layout tab . . . . .	331
Section Control tab . . . . .	332
Rate Control tab . . . . .	334
Sensors tab. . . . .	337
Operation tab . . . . .	338
Material Setup Complete screen . . . . .	338
Calibrating the implement lift switch . . . . .	339
Calibrating the modules . . . . .	339
Operating in the field . . . . .	341
Using the Diagnostics tab. . . . .	342
<b>11 The GreenSeeker Plugin . . . . .</b>	<b>345</b>
Introduction . . . . .	346
Definitions . . . . .	346
GreenSeeker primary components . . . . .	347
Interface module . . . . .	348
GreenSeeker sensors. . . . .	348
Sensor mounting bracket. . . . .	348
Care and maintenance. . . . .	349
Field preparations for Nitrogen application. . . . .	349
Field information. . . . .	349
Field setup . . . . .	350
Field preparations for user defined rate. . . . .	351
Operating the GreenSeeker Plugin . . . . .	352

GreenSeeker plugin screen . . . . .	353
GreenSeeker diagnostics . . . . .	359
Application information. . . . .	360
Delivery System and Liquid Control . . . . .	360
Selecting a nozzle. . . . .	361
Best practice . . . . .	361
<b>12 The TrueGuide Plugin . . . . .</b>	<b>363</b>
Connecting the TrueGuide implement guidance system . . . . .	364
Configuring the TrueGuide implement guidance system . . . . .	365
TrueGuide implement setup. . . . .	365
Setting up the TrueGuide system. . . . .	366
Calibrating the TrueGuide implement guidance system . . . . .	367
Engaging and disengaging the TrueGuide system . . . . .	368
Operating the TrueGuide system. . . . .	369
TrueGuide system aggressiveness settings . . . . .	371
<b>13 The TrueTracker Plugin . . . . .</b>	<b>373</b>
About the TrueTracker system. . . . .	374
Terminology . . . . .	374
Benefits of the TrueTracker system . . . . .	375
Requirements of the TrueTracker system. . . . .	375
Installing the TrueTracker system . . . . .	375
Configuration . . . . .	375
Activating the TrueTracker system. . . . .	376
Configuring the implement settings . . . . .	376
Configuring the Vehicle tab . . . . .	376
Configuring the Engage tab . . . . .	377
Configuring the Steering tab. . . . .	378
Configuring the implement controller. . . . .	379
Engage button. . . . .	380
Configuring the implement . . . . .	381
Calibrating the implement . . . . .	382
Configuring the antenna position and roll offset correction . . . . .	390
Calibrating the line acquisition aggressiveness . . . . .	393
Using the TrueTracker system . . . . .	394
Main guidance screen . . . . .	394
Implement lightbar . . . . .	394
Implement GPS information button. . . . .	395
Implement status text items. . . . .	395
Implement tab . . . . .	396
<b>14 The Serial Rate Control Plugin . . . . .</b>	<b>397</b>
Non-Trimble variable rate controllers . . . . .	398
Installing a non-Trimble variable rate controller . . . . .	398
Enabling the Serial Rate Control plugin. . . . .	399

Configuring the spray boom in the FmX integrated display . . . . .	399
Enabling and configuring the variable rate controller (in the FmX integrated display) .	399
Configuring the variable rate controller. . . . .	401
Setting any other features of the variable rate controller . . . . .	406
Additional information for non-Trimble variable rate controllers. . . . .	407
Prescriptions. . . . .	407
<b>15 The Remote Output Plugin . . . . .</b>	<b>409</b>
Connecting remote output . . . . .	410
Configuring the Remote Output plugin . . . . .	410
Calibrating the lead time for your implement . . . . .	412
Setting the front/back offset . . . . .	413
Calibrating the front/back offset . . . . .	413
Setting the lead time. . . . .	413
<b>16 The Serial Data Input Plugin . . . . .</b>	<b>415</b>
Connecting serial data input . . . . .	416
Configuring serial data input. . . . .	416
<b>17 The Productivity Monitoring Plugin . . . . .</b>	<b>419</b>
Installation . . . . .	420
Configuring the Productivity Monitoring plugin . . . . .	420
Operation . . . . .	422
<b>18 The Yield Monitoring Plugin . . . . .</b>	<b>423</b>
Introduction . . . . .	424
Definitions . . . . .	424
Auto width detection . . . . .	424
Operating the Yield Monitoring plugin. . . . .	424
Yield Monitoring Run screen. . . . .	424
General setup information . . . . .	427
Setting up the Yield Monitoring plugin . . . . .	427
Setup tab . . . . .	428
Operation tab . . . . .	429
Crop tab. . . . .	430
Map Legend tab. . . . .	431
Serial tab . . . . .	431
Error messages . . . . .	432
Third-party display instructions. . . . .	434
Setting up the Claas Cebis Quantimeter . . . . .	434
Calibrating the Claas Cebis Quantimeter. . . . .	435
Calibrating the Claas Cebis Auto Pilot. . . . .	436
Configuring the Stop Head Height on the Greenstar Monitor . . . . .	436
Configuring the Stop Head Height on the Command Center . . . . .	436
Calibrations . . . . .	437
Updating the Moisture Sensor (60 Series combines only). . . . .	440



Yield Monitoring Diagnostics . . . . .	441
. . . . . Yield Monitor tab	442
Inputs tab. . . . .	442
<b>19 VRS Plugin for DCM-300 and Ag3000 Modems . . . . .</b>	<b>443</b>
DCM-300 modem. . . . .	444
Introduction to the DCM-300 modem. . . . .	444
Benefits of using a DCM-300 modem . . . . .	444
Connecting the DCM-300 modem . . . . .	445
Unlocking the DCM-300 modem with passcodes . . . . .	446
Activating the DCM-300 modem. . . . .	446
Configuring the DCM-300 modem. . . . .	447
Ag3000 modem . . . . .	449
Introduction to the Ag3000 modem . . . . .	449
Connecting the Ag3000 modem . . . . .	449
Activating the Ag3000 modem . . . . .	450
Configuring the Ag3000 modem . . . . .	450
<b>20 The EZ-Remote Joystick . . . . .</b>	<b>453</b>
Requirements . . . . .	454
Installation . . . . .	454
Enabling the EZ-Remote Joystick . . . . .	454
<b>21 The LB25 External Lightbar . . . . .</b>	<b>457</b>
Configuring the lightbar. . . . .	458
<b>22 Advanced Configuration . . . . .</b>	<b>461</b>
Configuring remote coverage logging . . . . .	462
Installing the logging option . . . . .	462
Enable the external switch . . . . .	463
Changing the password . . . . .	464
Locking the display (to re-enable the password) . . . . .	464
Saving the vehicle configuration. . . . .	464
Saving a PDF version of the current field . . . . .	465
Upgrading the FmX integrated display firmware . . . . .	466
Upgrading the Field-IQ system firmware . . . . .	467
Unlocking additional devices. . . . .	468
<b>23 Data Management . . . . .</b>	<b>469</b>
Transferring data to an office computer. . . . .	470
Data formats . . . . .	470
Editing files. . . . .	471
Generating files in the office . . . . .	471
Folders on the USB memory stick. . . . .	472
The <b>Ag</b> GPS folder. . . . .	473
Client folder . . . . .	474

Farm folder . . . . .	475
Field folder . . . . .	475
Event folder . . . . .	477
TaskData folder . . . . .	477
Files on the USB memory stick . . . . .	478
Field boundary and AB Line files . . . . .	478
Coverage logging data . . . . .	479
Track logging files . . . . .	479
Event History file . . . . .	480
Features files . . . . .	481
Program Log message file . . . . .	482
Importing AB Lines or boundaries . . . . .	482
The Prescriptions folder . . . . .	484
Copying or deleting data files . . . . .	485
Accessing data files from the Home screen . . . . .	485
Accessing the data files through the Configuration screen . . . . .	485
Copying data . . . . .	486
Deleting data . . . . .	486
Data dictionaries . . . . .	488
<b>24 Troubleshooting . . . . .</b>	<b>491</b>
Advanced diagnostics . . . . .	492
Viewing raw serial data . . . . .	493
Restoring default settings . . . . .	494
Viewing FmX integrated display diagnostic information . . . . .	495
Display configuration information . . . . .	495
USB memory stick information . . . . .	495
Viewing vehicle diagnostic information . . . . .	495
Vehicle Diagnostics: Guidance screen . . . . .	496
Vehicle Diagnostics: Steering screen . . . . .	497
Vehicle Diagnostics: Details screen . . . . .	498
Autopilot Faults screen . . . . .	499
View Warning screen . . . . .	499
GPS Status screen . . . . .	500
Screen snaps . . . . .	500
Forcing the system to turn off . . . . .	501

# Introduction

This manual describes how to install, configure, and use the available plugins for the Trimble® FmX® integrated display version 5.11.

Even if you have used other Global Positioning System (GPS) products before, we recommend that you spend some time reading this manual to learn about the special features of this product. If you are not familiar with GPS, visit the Trimble website ([www.trimble.com](http://www.trimble.com)) for an interactive look at Trimble and GPS.

## About the product

The Trimble FmX integrated display, which consists of both software and hardware, is an easy-to-use advanced field management system. The software runs on a 30 cm (12") touch-sensitive, color LCD screen.

The FmX integrated display is the highest level display for agricultural purposes by Trimble.

The display is compatible with the Autopilot™ automated steering system. For several years, the Autopilot system has been the most accurate system for agricultural guidance by Trimble. Now, with the FmX integrated display, that same accuracy can be controlled with a touch-screen interface to provide easy, precise, and reliable steering.

With the additions to the software in version 5.11 you can use the FmX integrated display to perform many other functions, including implement guidance or field leveling.

## Using this manual

The FmX integrated display uses segments of product functionality called *plugins* to add or remove display options.

This manual contains a description of all the plugins, however, it is unlikely that you will use all of the plugins.

## Related information

Sources of related information include the following:

- Release notes: The release notes describe new features of the product, information not included in the manuals, and any changes to the manuals. The release notes are available at [www.trimble.com](http://www.trimble.com).
- Trimble training courses: Consider a training course to help you use your GPS system to its fullest potential. For more information, go to the Trimble website at [www.trimble.com/training.html](http://www.trimble.com/training.html).

## Technical assistance

If you have a problem and cannot find the information you need in the product documentation, *contact your local reseller*.

## Technical Support

To contact Trimble Technical Support:

1. Go to the Trimble website ([www.trimble.com](http://www.trimble.com)).
2. Click the **Support** button at the top of the screen. The Support A–Z list of products appears.
3. Scroll to the bottom of the list.
4. Click the **submit an inquiry** link. A form appears.
5. Complete the form and then click **Send**.

Alternatively, you can send an email to [trimble\\_support@trimble.com](mailto:trimble_support@trimble.com)

## Your comments

Your feedback about the supporting documentation helps us to improve it with each revision. Email your comments to [ReaderFeedback@trimble.com](mailto:ReaderFeedback@trimble.com).

# Display Overview

## In this chapter:

- System components
- Using the FmX integrated display
- Installing the display
- Connecting the display
- Inserting a memory stick into the USB socket
- External lightbar/s

The FmX integrated display is a touch-sensitive screen that runs field management software.

This chapter introduces the FmX integrated display and some of the basic operations.

Also covered is the usage of the FmX integrated display's mapping and guidance features. The chapter explains how to set up and use the field features, and how to perform steering navigation.



## System components

### Pack-out contents

The box contains the following components:

- The FmX integrated display
- The mount bracket and screws
- GNSS antenna
- GNSS antenna mounting plate
- Power cables
- Quick reference card
- Documentation CD
- Radio antenna (RTK only)



Item	Description
①	FmX integrated display
②	RAM mount and screws

## Front view



Item	Description
1	12" touch-sensitive screen

In the field, the easiest way to interact with the system is to tap the touch-sensitive screen with your finger.



**CAUTION** – Do not press on the screen with a sharp item, such as a pencil; you may damage the surface of the screen.

## Rear view

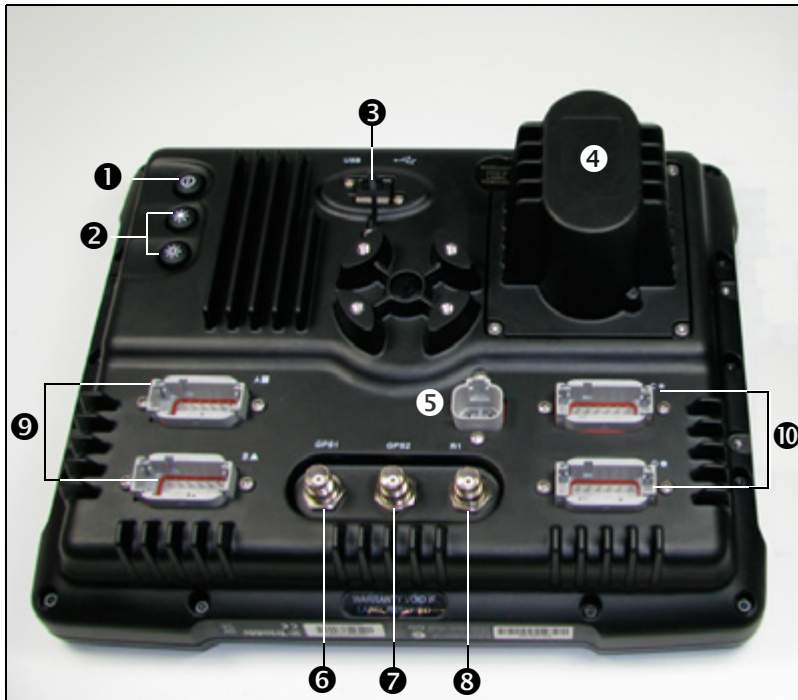

Item	Description
1	Power button
2	Brightness controls
3	USB socket
4	Backup battery housing
5	Power connection socket
6	Primary GPS connector
7	Secondary GPS connector
8	RTK antenna connector
9	CAN communication sockets (A / B)
10	Serial communication sockets (C / D)

### Power button

To turn the display on or off, press and hold the power button for approximately 0.5 seconds.

### Brightness controls

To increase or decrease the brightness of the FmX integrated display, press the corresponding button.

**USB socket**

You can connect a USB memory stick to the display to transfer data to and from the unit.

**Power connection socket**

Connects the power cable (P/N 66694) to the display.

**Primary / secondary GPS connector**

Connects the GPS cable (P/N 50449) to the display.

**RTK connector**

Connects the RTK cable (P/N 62120) to the display.

**Serial / CAN sockets**

Connects external devices to the display. For example, you can use these sockets to attach devices like AgCam cameras.



**System software**

The FmX integrated display includes the following features:

- Field definition and mapping
- Feature mapping
- Guidance to predefined field patterns
- Logging of coverage data
- Variable rate control
- Boom/Row switching
- Logging of topographic mapping data
- Output of information for analysis in office-based Geographic Information System (GIS) software
- Seed, Liquid, Granular, and Anhydrous Ammonia control
- Seed monitoring

## Control buttons

On the display's Home screen and Run screen, there are three touch-sensitive buttons on the right side:

Press this button ...	To ...
	Exit the current screen.
	Access the <i>Configuration</i> screen (see <a href="#">page 30</a> ) via the <i>Current Configurations</i> screen.
	Access the Run screen (see <a href="#">page 31</a> ) via the <i>Configuration Selection</i> screen.

## Touch screen elements

The following interactive features appear on the touch screen:

- Virtual buttons
- Virtual keyboard
- Virtual number pad
- Drop-down boxes
- Slider bars
- Lists

For more information, see Slide-out tabs in [Status items, page 79](#).

## Virtual buttons

The most common way to interact with the display is to use the virtual buttons.

Treat a virtual button as you would a normal button. To “press” the button, tap the area of the screen where it appears:

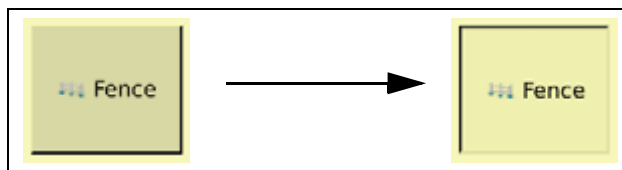



Some FmX integrated display buttons have a direct action, while others change to show that a feature is enabled or disabled:

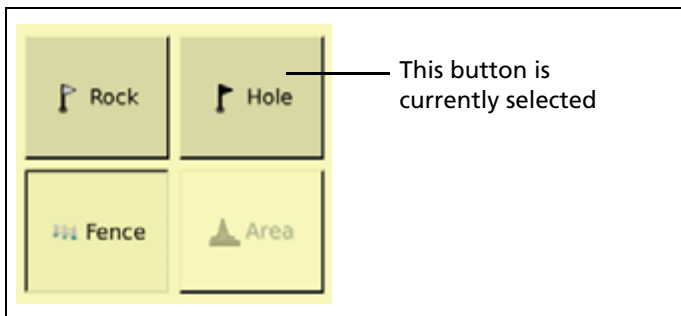

### Virtual keyboard

Use the virtual keyboard to enter text and numbers:

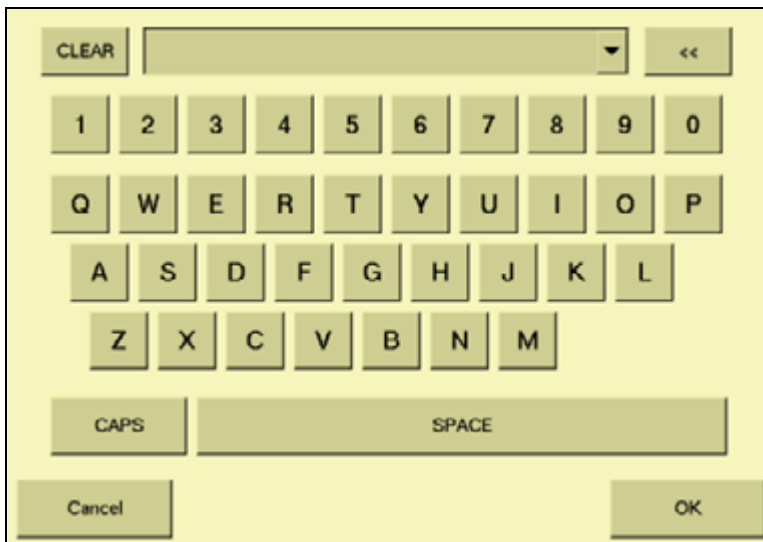

To...	Tap...
enter a letter or number	the appropriate button
enter caps mode	the <b>CAPS</b> button
leave caps mode	the <b>CAPS</b> button again
erase a letter that you have typed by mistake	the << (backspace) button
clear all the text you have entered	the <b>CLEAR</b> button
finish entering text	the <b>OK</b> button

## Virtual number pad

The virtual number pad works in the same way as the virtual keyboard.

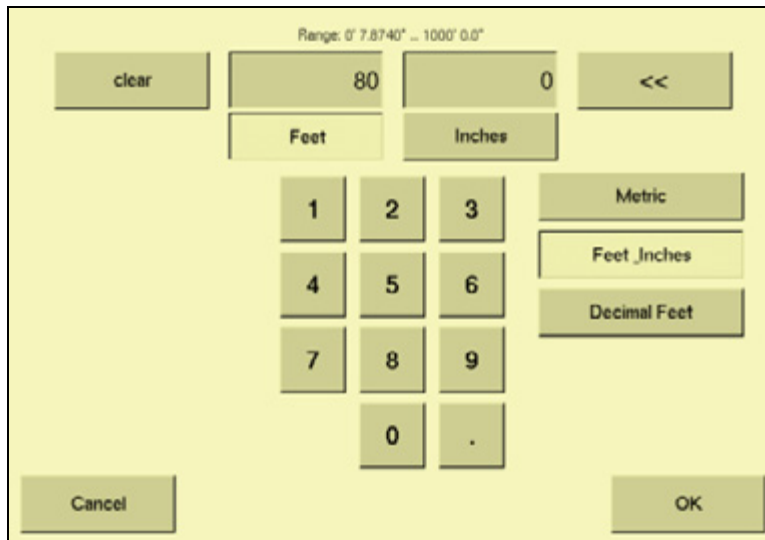

Select the **Metric**, **Feet\_Inches**, or **Decimal Feet** button to change the units.

 **Tip** – When you change units, the number value in the window is automatically converted to the new unit, so select the correct units **before** you enter a number value.

## Drop-down boxes

A drop-down box, if provided, lists the options you can select from the current list:

To select an item:

1. Tap the list once to open the drop-down list.
2. Tap the required item from the list.

The drop-down list disappears and the selected item appears in the field.

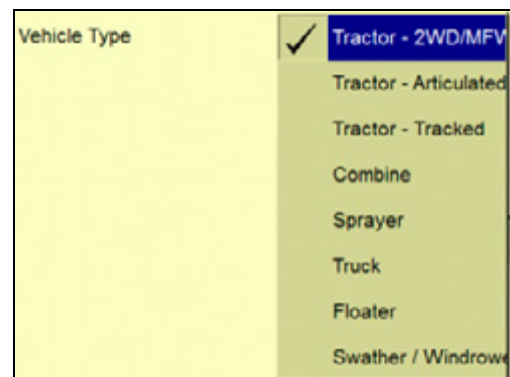

## Slider bars

Slider bars appear on several of the configuration screens.

A slider bar shows how extreme a selection is. If you use a slider bar to select the value, it is apparent that you are nearing the extreme value.



There are two ways to use a slider bar:

- To move up by one increment, tap on the slider bar in the direction that you want to move the pointer.
- To slide the pointer:
  - a. Touch the screen where the pointer is located and hold your finger on the screen.
  - b. Move your finger along the axis, in the direction that you want to move the pointer.
  - c. Remove your finger when you are satisfied with the position of the pointer.

## Lists

A list shows all the available options. To select an item from a list, tap the item.

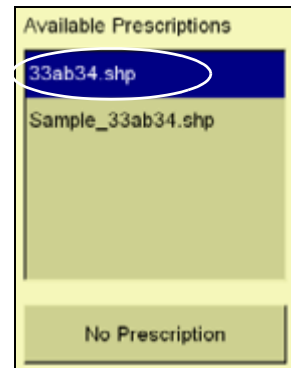

## Folder hierarchy

The FmX integrated display stores data in a folder hierarchy according to client, farm, field, and event.

Item	Description
Client	The customer for whom the work is being done.
Farm	A collection of fields (see below).
Field	A specific area of land where events are carried out. A "field" can be created on the display to represent an actual field, part of an actual field, or a group of more than one actual fields.
Event	A precision agriculture application or activity on a particular field (see above). For example: <ul style="list-style-type: none"> <li>• Planting of seed</li> <li>• Application of fertilizer or lime</li> <li>• Spraying with fungicide, herbicide, or insecticide</li> </ul>

Each client may have several farms, each of the farms may consist of several fields, and each field may be broken into a number of events.

## Using the FmX integrated display

### Turning on the display

Briefly hold down the power button ( for approximately half a second). The display turns on, and after a pause the Home screen appears.

The FmX integrated display has three main screens:

- Home screen
- *Configuration* screen
- Run screen

To access each of these screens, tap the appropriate button on the right of the display. For more information, see [Control buttons, page 24](#).

### Turning off the display

Close all fields before you turn off the system. To close a field, see [Closing a field, page 44](#).

There are several ways to turn off the display:

- Return to the Home screen and then tap **Shutdown**.
- Hold down the power button (on the reverse of the display) for approximately half a second.

***Note** – There is sometimes a short delay between the time when you tap the power button and when the display turns off. This is because the display is saving settings.*

## Home screen



The Home screen lists the following information about the display:

- The display build date, firmware, and hardware version.
- The Autopilot controller version, date, and serial number.
- The GPS receiver version, correction source, and subscription information.
- The selected vehicle make and model.

**Note** – If you connect **two** Autopilot NavController II controllers, the Home screen shows a summary of both controllers.

## Configuration screen

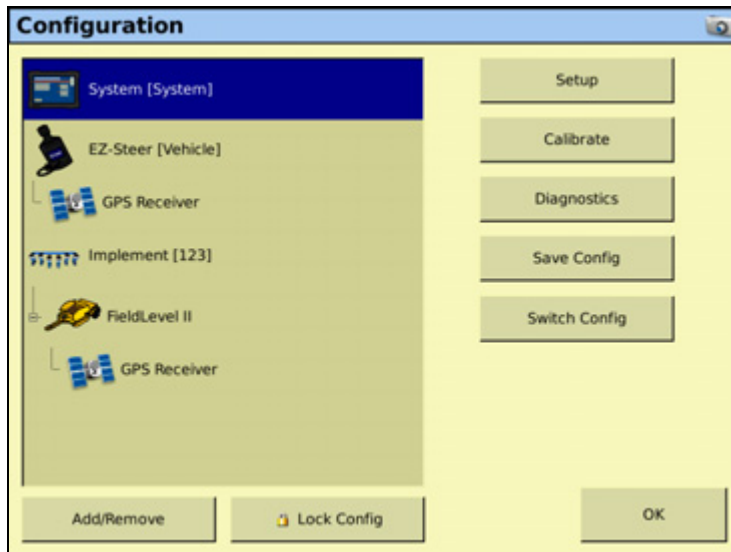

The *Configuration* screen enables you to create, edit, and save various editable system settings, and add or remove system options. For more information on using the Configuration screen, see [Accessing the system configuration settings, page 72](#).

**Note** – Some configuration settings are unavailable when a field is open in the Run screen. To access these settings, return to the Run screen and then tap the Home button. When prompted to close the field, tap **Yes**.

## Run screen

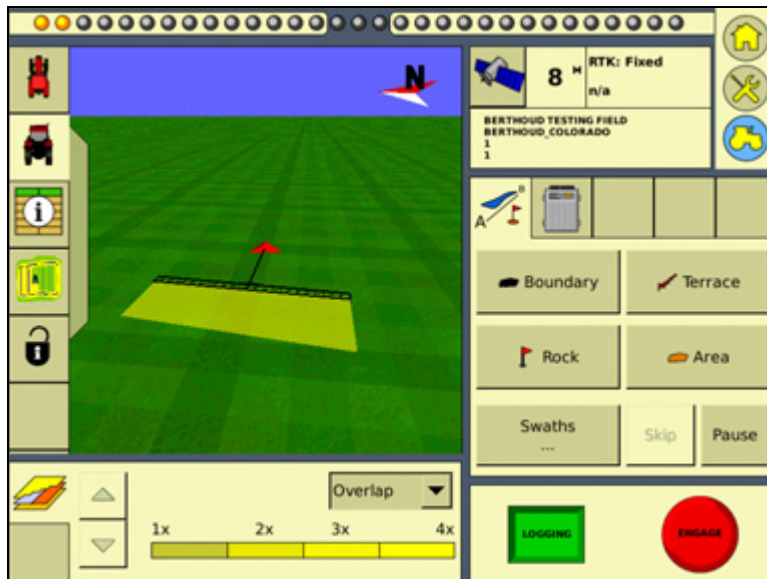

The Run screen shows the steering navigation. If you select the Run screen and you have a field open, the display shows that field. If you select the Run screen when there is no field open, the *Field Selection* screen appears.

### Run screen view modes

The FmX integrated display screen has two views for representing vehicle guidance on the Run screen:

- Overhead view: Shows a bird's-eye view of the field, with the vehicle in it.

- Trailing view: Shows a three-dimensional representation of the field from the driver's perspective:

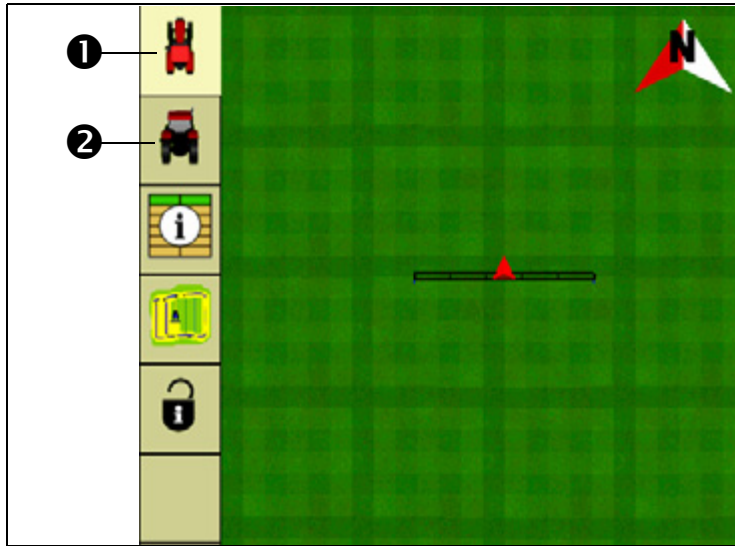

Item	Description
①	Main view (in this example, overhead view)
②	Auxiliary view (trailing view)

To change the view mode, tap the icons in the upper-left of the run screen.

### Zoom and Pan functions

The FmX integrated display has five levels of zoom. A close-up view of the vehicle enables you to navigate more accurately, while a long view enables you to see more of the field.

New in version 3.0 of the FmX integrated display is a pan function on the Run screen that gives you the ability to view the field outside of the normal viewing area.



## Accessing the zoom and pan functions

- To access the zoom and pan functions from the Run screen, press .

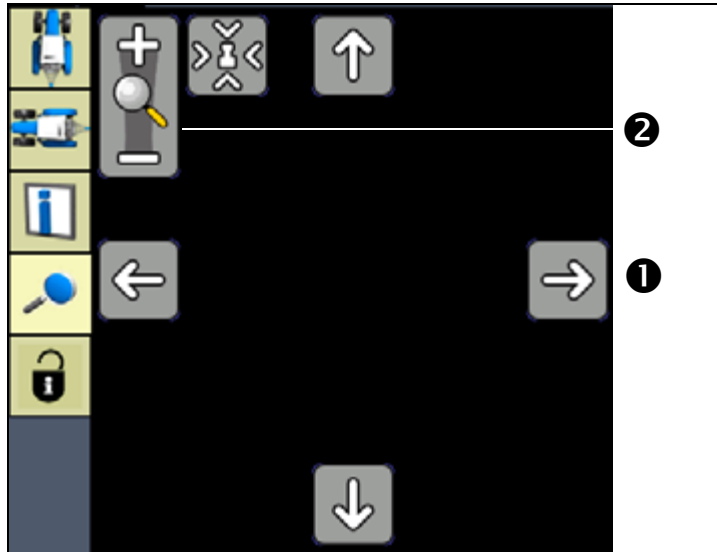

- To pan around the field, press one of the four arrow icons **1** positioned at the edge field area.
- To zoom in and out, tap either the plus (+) or minus (-) symbol linked to the magnifying glass **2**.

**Note** – Tapping the field area of the Run screen when in zoom and pan mode turns the magnifying glass zoom feature on and off.

The fifth level of zoom in the pan view is a summary view of all your coverage. It adjusts, depending on the size of the field. It does not include grid lines.

 **Tip** – If you close the field, create a second field and then show the summary view, the summary view may be zoomed to show the area of both fields. To avoid this, restart the display. The view will be correct.

For more information on using the Run screen, see [The Run screen layout, page 45](#).

## Context-sensitive help

The FmX integrated display has context-sensitive help screens that provide details and helpful information about the current screen. To access the help, tap **?**:

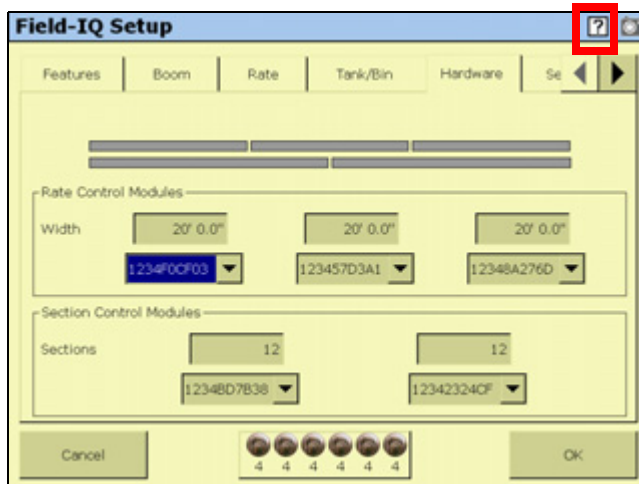

A *Help* screen, similar to the one show below, appears. To exit the *Help* screen and return to the previous screen, tap **OK**:

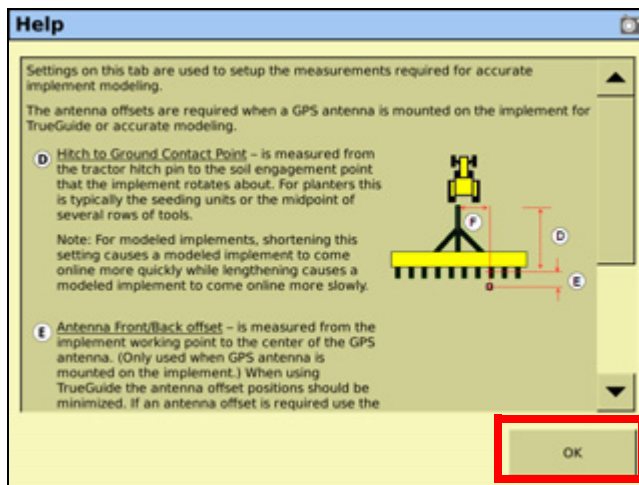

## Installing the display

Mount the FmX integrated display in the vehicle cab, in a position that is easily accessible.

1. Use the included M6 x 1" screws to firmly screw the mounting plate to the back of the display:



2. Attach the RAM mount to the ball on the mounting plate:



3. Select a position in the cab for the display. The FmX integrated display is mounted in the cab with a bar style RAM mount.
4. Use the provided bolts to attach the bar mount to the rail.



5. Hold the display in the selected location to ensure that it is comfortably accessible from the driver's seat.
6. Attach the other end of the RAM mount to the ball on the bar mount and then tighten the screw.

## Connecting the display

**Note** – The FmX integrated display connects to the Autopilot automated steering system. The Autopilot system requires professional installation in your vehicle. If the Autopilot system is not currently installed in your vehicle, consult your local reseller.

1. Connect one end of the Autopilot harness to the vehicle.
2. Connect the Autopilot-to-FmX cable to port C of the FmX integrated display.
3. Connect the implement switch, if required.

## Inserting a memory stick into the USB socket

The USB socket (❶) is on the rear of the display.



**CAUTION** – Do not remove the USB memory stick from the socket while the display is writing to or from the device. This will corrupt the data.



**CAUTION** – If required, only use a USB hub that has an external power option; connecting multiple USB devices to the display without this could damage the USB port.

To insert the USB memory stick:

1. Rotate the display so you can see the back of it.
2. Insert the USB memory stick into the USB socket.

To remove the USB memory stick:

1. Rotate the display so that you can see the back of it.
2. Pull the USB memory stick out of the USB socket.

The display automatically detects when a memory stick is inserted or removed.

## External lightbar/s

The FmX integrated display also supports one or more LB25 external lightbars.

Purchased separately from the display, the LB25 lightbar can be mounted directly on the display, horizontally **1** or vertically **2**, using the hardware that is supplied with the lightbar, or mounted separately from the display in another part of the vehicle's cab using the supplied suction cup mount **3**:

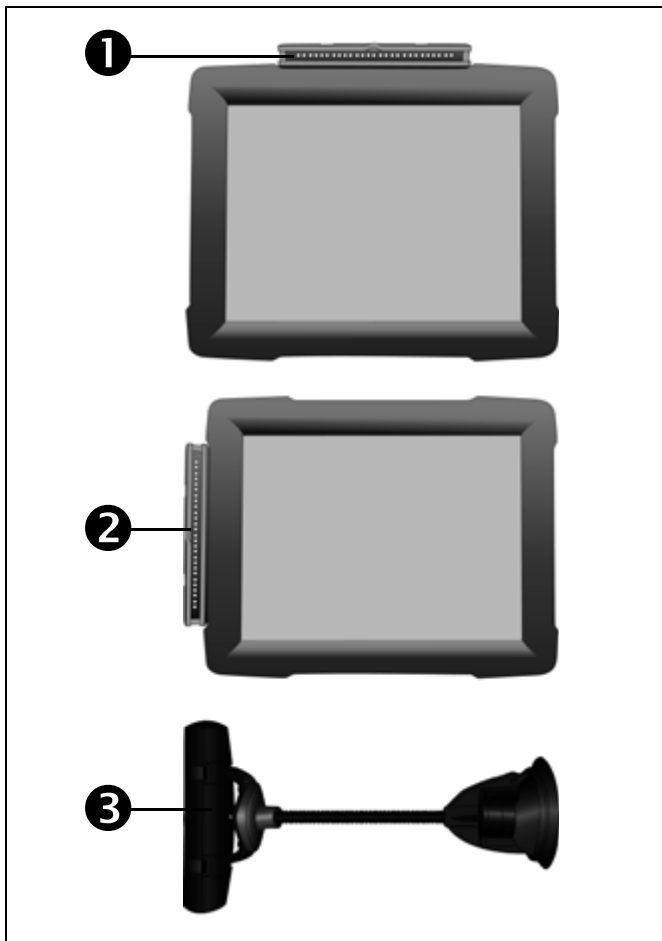

The lights on the external lightbar replicate the operation of the lights on the display's virtual lightbar.

For more information on installing and configuring the LB25 external lightbar, see [Chapter 21, The LB25 External Lightbar](#).

## Getting Started

- Introduction to field features
- Starting a field
- Closing a field
- The Run screen layout
- Introduction to coverage logging
- Prescriptions

This chapter explains the basic usage and concepts of the FmX integrated display.



## Introduction to field features

You can place field features in the field to define points of interest or areas to avoid. There are three types of field feature:

Feature type	Defines	Example
Point	A single point in a field	Tree
Line	A straight or curved line in a field	Fence
Area	An area of land	Pond

Configure field features that you will want to add to your fields and then assign up to four of them to buttons. These buttons appear on the *Mapping* tab on the Run screen. You can then use the buttons to add field features to your map while driving:

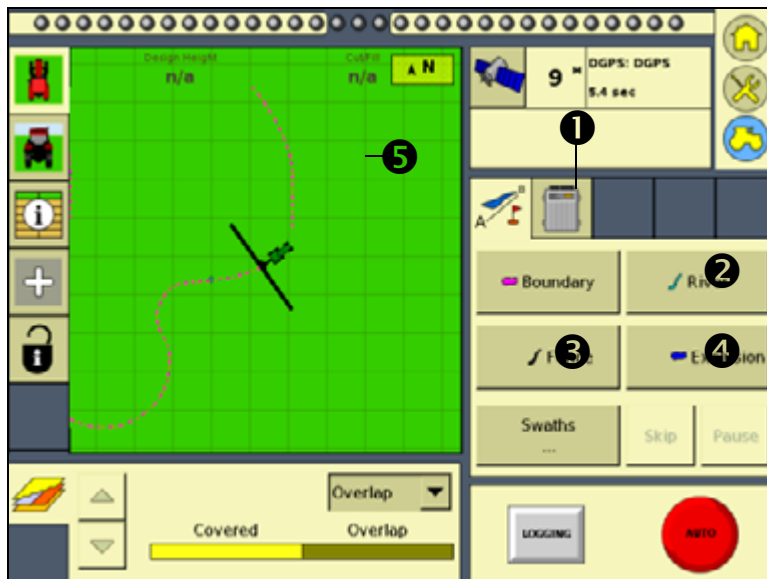

Item	Description
①	Mapping tab
②	Feature button set up to represent a river
③	Feature button set up to represent a fence
④	Feature button set up to represent an exclusion
⑤	Area feature drawn with the Boundary feature button

*Note* – For more information on setting up the **Feature** buttons, see [Feature mapping, page 89](#)



## Starting a field

This is the screen where you either re-open an existing field or create a new field. You must select a Client, Farm, Field, and Event, in that order.

**Note** – *The first time that you use the Field Selection screen, there are no existing fields so you must create one.*

1. From the Home screen, tap  :

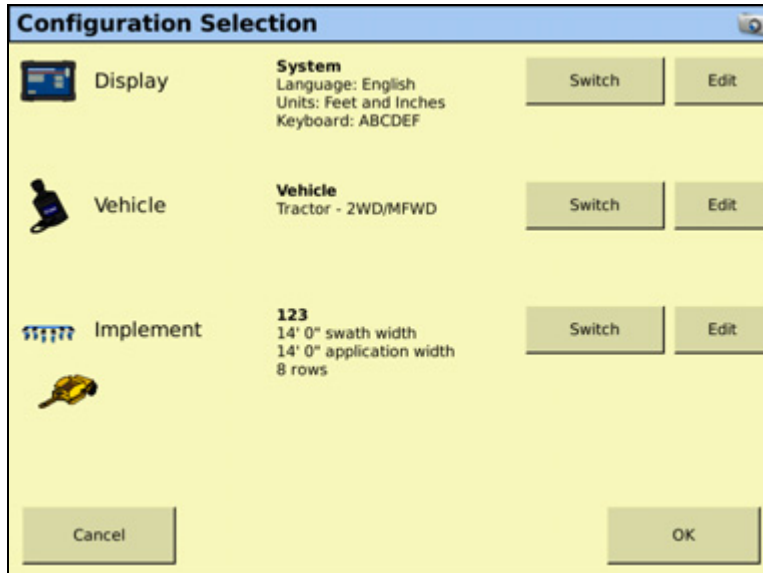

2. From the *Configuration Selection* screen, tap **OK**:

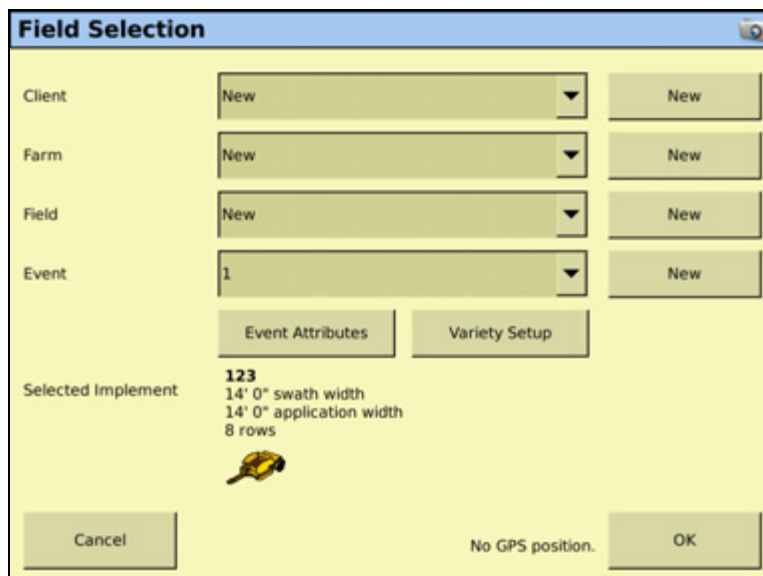

3. Do one of the following:
  - Create a new client. See [Creating a client, page 42](#).
  - Select an existing client from the *Client* drop-down list. The *Farm* list now contains only the farms associated with that client.
4. Select the appropriate farm or create a new one.
5. Select the appropriate field or create a new one.
6. Select the appropriate event or create a new one.
7. To add more information for record keeping, tap **Event Attributes**. The *Event Attributes* screen appears. See [Adding record-keeping information, page 42](#).
8. To add and edit information on the variety of products that can be distributed from the implement tap **Hybrid Setup**. See [Logging varieties, page 65](#)
9. Tap **OK** to enter the Run screen.

Once you create the field, select a swath pattern to use while you drive the field. See [Selecting a swath pattern, page 51](#).

## Creating a client

1. Tap **New** beside the *Client* list and then use the virtual keyboard to enter a client name.
2. Repeat this process to create a farm, field, and event (and record-keeping Event Attributes, if required).

*Note* – You can also enter Client, Farm, Field and Event information using the Data Dictionary. [Data Dictionary, page 95](#).

## Additional settings

### Limit Field Selection Filter

When opening existing fields, the FmX integrated display can limit the number of fields displayed based on a pre-defined distance from the current GPS position. For more information on configuring the filter, see [Enabling the Limit Field Selection filter, page 98](#).

### Adding record-keeping information

To add the following categories, tap **Event Attributes**:

Item	Description
Operator name	The name of the vehicle operator
Operator EPA#	The vehicle operator's EPA license number for spreading restricted-use or state-restricted pesticides or herbicides
Harvest Year	The year that the crop is going to be harvested
Farm Location	The country or region where the farm is located

---

<b>Item</b>	<b>Description</b>
Vehicle	The vehicle used in the operation
Implement	The implement connected to the vehicle
Application Method	The application method used (for example, spraying, seeding, or harvesting)
Wind speed	The average wind speed
Wind gust speed	The maximum speed of any wind gusts
Wind direction	The average wind direction
Sky conditions	The amount of cloud cover
Soil conditions	A description of the state of the soil
Soil type	A description of the soil type in the field
Temperature	The current temperature
Relative humidity	The humidity percentage
Crop	The crop grown in this field
Target pests	(If spraying) the pest that the spray targets
Custom 1	Additional information of your choosing
Custom 2	Additional information of your choosing
Custom 3	Additional information of your choosing
Custom 4	Additional information of your choosing
Material	The material being applied

## Closing a field

Once you finish using a field, tap  to close it. The following dialog appears:

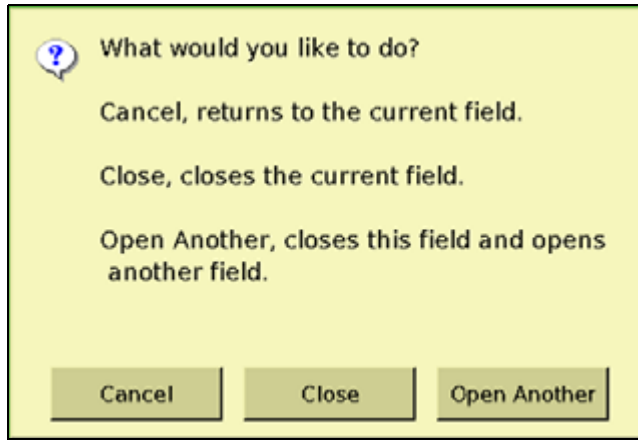

Tap...	To...
Cancel	Return to the currently open field.
Close	Close the current field and return to the Home screen.
Open another	Close the current field, and open a new field.

## Saving an event summary

When a field is closed, the system saves an HTML summary for the event. To reduce the time it takes to close a field, saving the summary file can be disabled. To turn Save Summaries off, do the following:

1. In the *Configuration* screen, select *System* and then tap **Setup**.
2. In the *Display Setup* screen, select *Map Settings* and then tap **Setup**.
3. In the *Mapping* screen, select On or Off from the *Save Summaries* list:

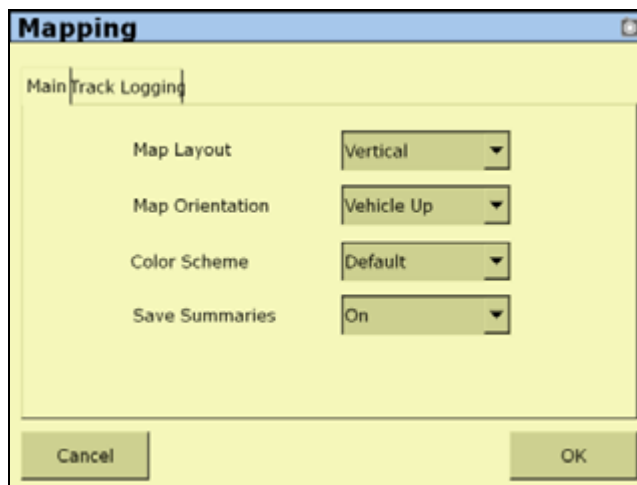

For more information, see [Saving a PDF version of the current field](#), page 465.

## The Run screen layout

The Run screen is where you receive guidance and drive the vehicle.

The appearance of the screen changes, depending on which plugins you have installed.

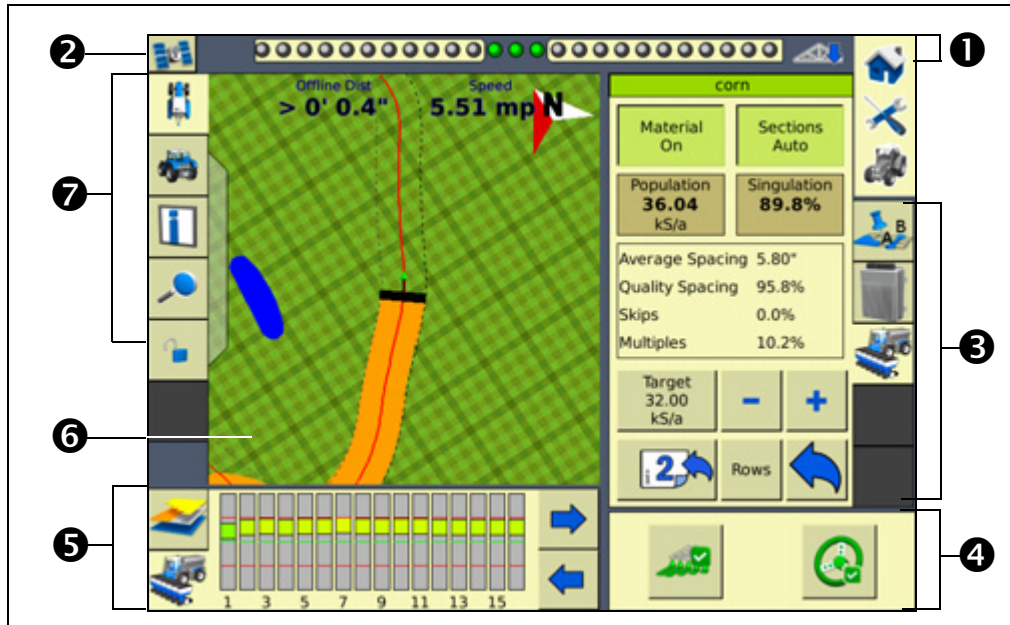

Item	Description
1	Virtual lightbar
2	Tap the icon to access GPS receiver(s) information
3	Plugin tabs
4	Logging and engage buttons
5	Plugin information tabs
6	Run screen
7	View mode / Zoom and Pan function and information buttons

These items are described in more detail below.

### Hashed grids

Hashed grids provide an immediate measure of distance. Each small square represents 10 feet, and each dark green outline represents 50 feet:

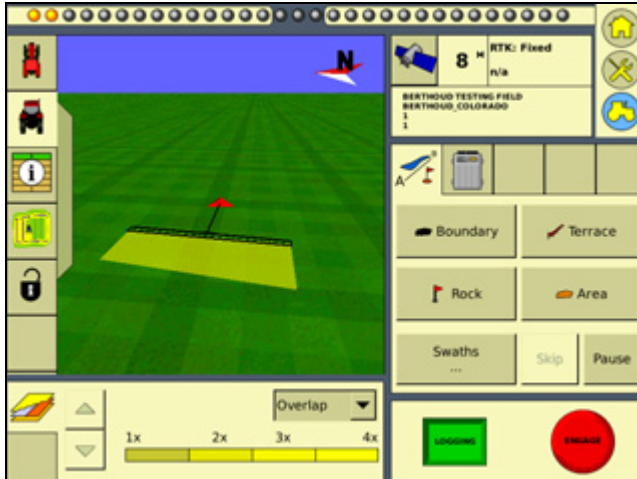

### Virtual lightbar

The virtual lightbar provides vehicle guidance. When the vehicle is perfectly on the guidance line, the three center (green) LEDs are lit:



When the vehicle moves off the guidance line to the left or the right, the three LEDs that are lit drift to the side:



To configure the virtual lightbar, see [Lightbar](#), page 96.

### Plugin tabs

Most of the plugins have features that appear on a tab on the Run screen. To select a tab, tap the icon in the tab:



## GPS receiver information

The button in the top right of the Run screen provides information about GPS:

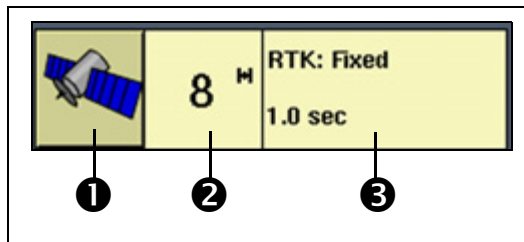

Item	Description
①	Satellite Information button
②	Current number of satellites
③	Type and age of correction

If the GPS signal is lost completely, the No GPS message appears.

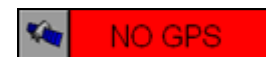

Tap the satellite information button to view the information on it.

There can be more than one row, depending on the plugin that is installed. If the plugin requires a second GPS receiver (for example, the second GPS receiver mounted on the implement for the TrueTracker™ system), then the upper information row relates to the vehicle GPS receiver and the lower information row relates to the second GPS receiver.

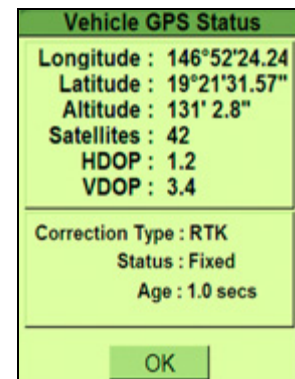

## Engage button

When you create a guidance line, you can use the **Engage** button to engage or disengage the Autopilot automated steering system. The button has three states:

Engage status	Button color	Vehicle icon color
Ready to engage		
Engaged		
Cannot engage		

To engage the vehicle, tap **Engage**. The system engages and the button turns green.

To disengage the vehicle, do one of the following:



- Turn the steering wheel to trigger the manual override.
- Tap **Engage**.

The system disengages and the **Engage** button turns gray.

If the button is red, tap it to find out why.

### Logging button

The **Logging** button engages and disengages coverage logging:

Logging button color		Meaning
Gray		Coverage logging is not engaged
Green		Coverage logging is engaged

### Plugin information tabs



As with the plugin tabs, the plugin information tabs that appear differ depending on which plugins are installed.

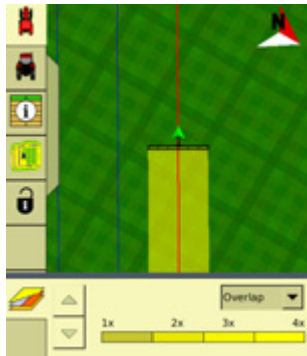

### Mapping information tab

The Mapping information tab enables you to view your coverage from a number of perspectives:

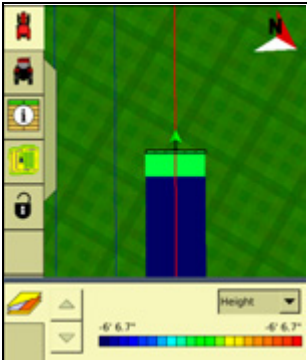
Setting	Example	Coverage shows
Overlap		General coverage and overlap

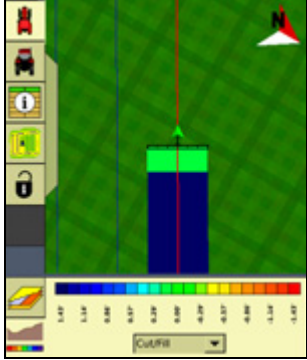
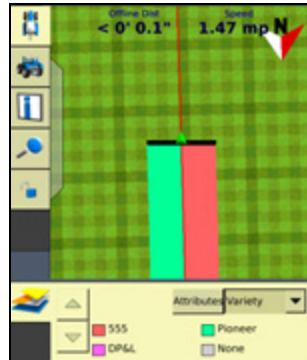

Setting	Example	Coverage shows
Height		Altitude of GPS receiver
GPS Quality		GPS signal quality
Cut/Fill (FieldLevel)		Cut and/or fill
Variety		Different varieties. See <a href="#">Logging varieties, page 65</a> .

Setting	Example	Coverage shows
Applied Rate		Shows variations in application rate.
Speed		Variations in the speed of the vehicle, as different colors on the Run screen.
Average Cross Track Error (XTE)		The position of the implement.

## Guidance window

The guidance window shows your vehicle, coverage, field features, and guidance lines, and for coverage mapping, sections appear on the implement:



For a description of how you can view the guidance window, see [Run screen view modes](#), page 31.

## Selecting a swath pattern

To obtain guidance with the FmX integrated display, you can use:

- One of the four standard swath pattern types
- The FreeForm guidance pattern. See [Creating guidance with the FreeForm pattern](#), page 56.

Use the standard patterns to create different shaped guidance lines on the display.

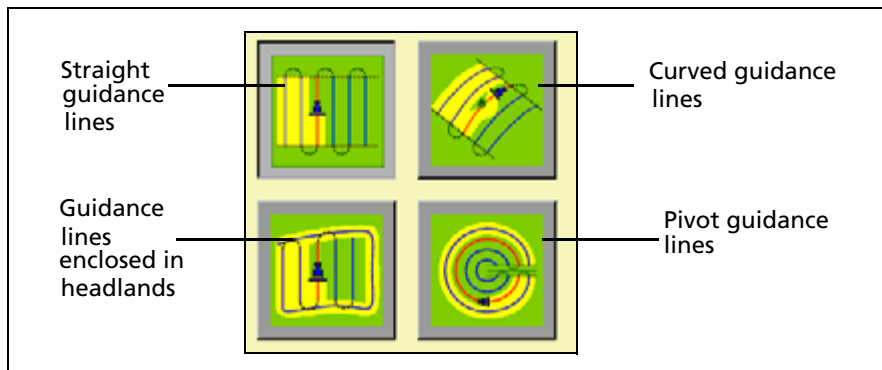

To select a swath pattern:

1. On the Run screen, select the *Mapping* tab:



2. Tap **Swaths**:

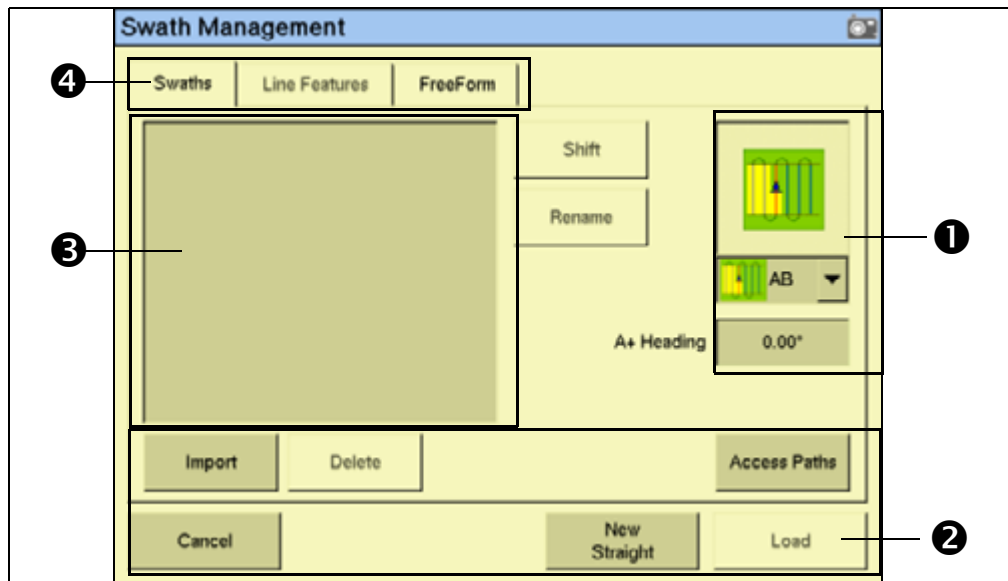

Item	Description
❶	Guidance patterns
❷	Line management buttons
❸	Existing guidance lines
❹	Guidance type buttons

3. Select the appropriate pattern from the drop-down list on the right of the screen.

## Creating a new line

The type of line that you can create depends on the swath pattern that you selected.

### Creating a straight line

There are two ways to create a straight line:

- **AB Line** – Define the start and end points.
- **A+ Line** – Define a point on the line and the heading direction.

To create a straight AB Line:

1. From the *Swath Management* screen, select the straight line field pattern.
2. Enter an access path, if required. See [Adding an access path, page 59](#).
3. Tap **New Straight**. The Run screen appears.
4. To create the start point of the line, tap **Set A**.
5. Drive to the end of the line. The end (B) point must be at least 50 meters (160 feet) from the A point.
6. Tap **Set B**. The new AB Line appears on-screen.  
To extend the line, drive further along it and then tap **Set B** again.
7. Tap **Done**.

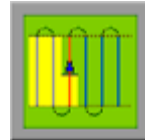

To create a straight A+ line by selecting one point and the angle:

1. From the *Swath Management* screen, select the AB Line field pattern.
2. Enter an access path, if required. See [Adding an access path, page 59](#).
3. In the A+ Heading window, enter the angle that you want the line to be on or select a previous AB Line to use its heading. The default angle is the same as the previous AB Line heading.
4. Tap **New Straight**. The Run screen appears.
5. Drive to the start of the line and then tap **Set A**.
6. Tap **Use A+**. The new A+ line appears.
7. Tap **Done**.

### Creating a curved line

1. From the *Swath Management* screen, select the Curve field pattern from the drop-down list.
2. Enter an access path, if required. See [Adding an access path, page 59](#).
3. Tap **New Curve**. The Run screen appears.
4. Drive to the start point of the curve and then tap **Set A**.

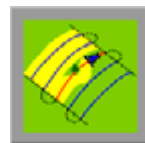

To stop recording your exact path and create a straight section of line, tap the **Record** button. See [page 55](#).

5. Drive the curve until you reach the end point and then tap **Set B**.  
The new curve appears.

### Creating a headland

A Headland is a straight AB Line or an A+ line pattern that is confined inside a boundary. This boundary is called the headland.

*Note – If you want to create a headland based on the A+ line pattern, select the straight line pattern and then set the A+ heading for the internal line. Then complete the following steps.*

1. From the *Swath Management* screen, select the Headlands field pattern from the drop-down list.
2. In the # *Headlands* window, enter the width of the headland boundary in swaths. For example, if you enter **2**, the headland will be 2 swaths wide.
3. Tap **New Headland**. The Run screen appears with the headland definition buttons on the Mapping tab.
4. Drive to the start point of the headland and then tap **Record**. A red line appears behind the vehicle to show that the headland is being recorded.

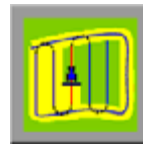

*Note – You must define the inner pattern before you complete the headland.*

5. To define the inner pattern, tap **Infill**. The Mapping tab changes to show the inner pattern buttons.



*Note – Once infill lines have been created, they cannot be moved.*

6. When you reach where you want the A point, tap **Set A**.
7. Do one of the following:
  - To create an internal AB Line, drive to where you want the B point (at least 50 m (164 ft)) and then tap **Set B**.
  - To create an internal A+ line, tap **Use A+**.
8. Tap **Back to HL**. The buttons on the Mapping tab change back to their original appearance.



When you complete the headland circuit, the system will draw a straight line from the vehicle back to the start point, so drive the vehicle to a position on the headland circuit where a straight line back to the start will not cut off part of the pattern.

9. Tap **Close HL**.  
The new headland appears.

### Creating a pivot

1. From the *Swath Management* screen, select the Pivot field pattern from the drop-down list.
2. Tap **New Pivot**.  
The Run screen appears.
3. Drive to a point on the outermost rut of the pivot and then tap **Set A**.
4. Follow the pivot rut around to the end and then tap **Set B**. The *Enter Distance to Pivot Field Edge* screen appears.
5. Enter the distance or the number of rows from the current path to the outside of the pivot and then tap **OK**.  
The pivot appears.

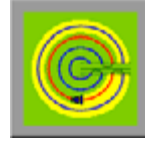

### Adjusting the outer edge radius

The pivot has an outer edge radius that is used to calculate coverage area. Once you create a pivot, you can adjust the outer edge radius:

1. From the Run screen, tap **Swaths**. The *Swath Management* screen appears.
2. Select the pivot to be adjusted from the list of available pivots.

**Note** – *The default is the AB curve.*

3. In the *Outer Edge Radius* window, adjust or enter the value that represents the distance from the pivot center to the outer edge and tap **OK**.  
The *Swath Management* screen appears.
4. To update the pivot, tap **Load**. The Run screen appears with the new pivot dimensions.

### The Record button

When you create guidance based on the curve or headland pattern, the **Record** button is available. The **Record** button enables you to insert a straight section of line, rather than having the line follow the exact path of the vehicle (as happens with direct mapping).

When you select (tap) **Record**, the line you are driving is mapped. When you deselect **Record**, the display stops directly mapping your path. Instead, a dotted line spans from the vehicle to the point where you deselected **Record**. When you select the button again, the line becomes solid and your path is mapped again:

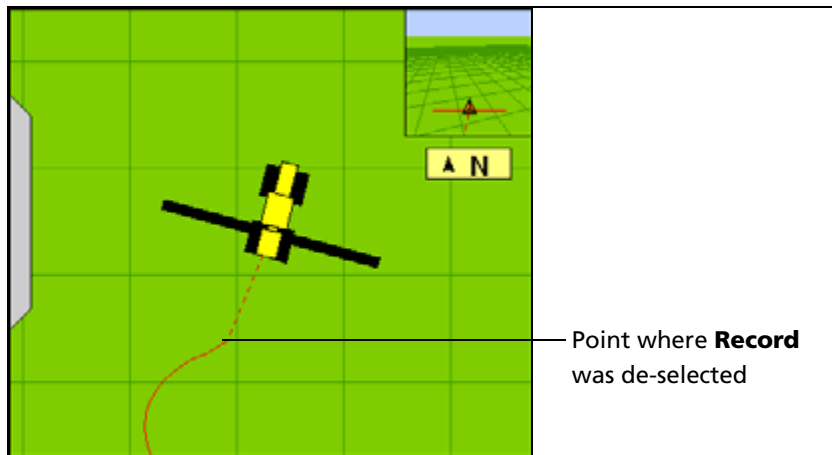

### Creating guidance with the FreeForm pattern

The FreeForm pattern is an advanced pattern that enables you to create multiple lines of different types in a single field to obtain guidance in fields of any shape. You need to record each line that you drive, to generate the next guidance line. You can create:

- Curved line segments
- Straight line segments in the form of straight AB Lines

With this combination, you can use the FreeForm pattern to create non-circular spirals or multiple curved guidance lines for irregular-shaped fields.



**Tip** – With FreeForm curves, remember that your next guidance line will appear only if you record your vehicle's path along the current guidance line. Record each pass to generate your next guidance line.

### Creating a FreeForm section

1. From the Run screen, tap **Swaths**. The *Swaths Management* screen appears.
2. Select the *FreeForm* tab (in the upper left of the screen). The **New FreeForm** button becomes available (toward the lower right of the screen).
3. If necessary, select the **Record FreeForm when logging** button. See [Recording FreeForm guidance simultaneously with coverage](#), page 58.
4. Tap **New FreeForm**. The Run screen reappears with the **Define FF**, **Next Path**, and **Pause** buttons on the *Mapping* tab.





### Creating a curved FreeForm section

1. Tap **Define FF**. The FreeForm buttons change.
2. Tap **FreeForm** to begin drawing a FreeForm line. The line follows the path of the vehicle.
3. To complete the FreeForm pattern, do one of the following:
  - De-select the **FreeForm** button.
  - Perform a U-turn.



*Note* – If you are driving an inward spiral, leave the **FreeForm** button selected. The segments will continue to be defined.

### Creating a straight FreeForm section

1. Tap **Define FF**. The FreeForm buttons change.
2. Drive to the start point of the line and then tap **Set A**.
3. Drive to the other end of the line and then tap **Set B**. The guidance line appears.



### Switching between FreeForm sections

You can switch (“snap”) between the different FreeForm sections. In the following example, there are 2 FreeForm sections:

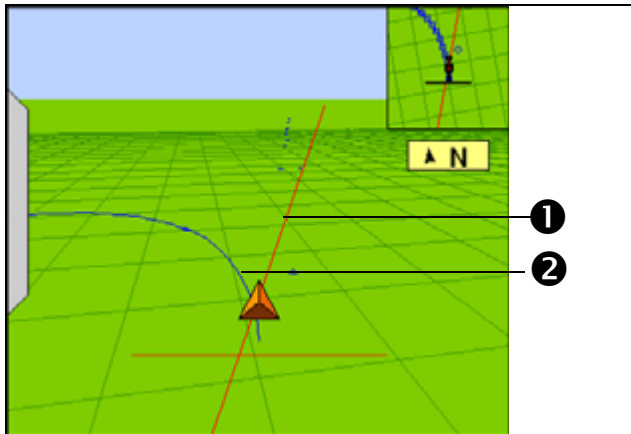

Item	Description
①	A straight FreeForm AB Line (selected)
②	A curved FreeForm section

You may want guidance along either line.

To snap between one section and another, tap the **Next Path** button on the Run screen (If the **Next Path** button is not available, tap **Back** and then tap **Next Path**). Guidance jumps to the next section:

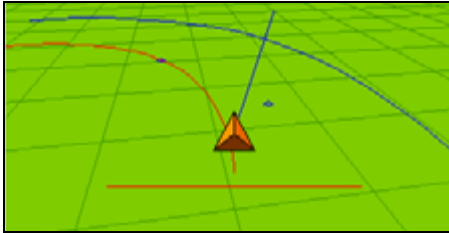

To cycle through the available sections, keep tapping **Next Path**.

*Note* – This selects a curve only if the curve is within the snapping zone.

### Recording FreeForm guidance simultaneously with coverage

When you select the FreeForm pattern on the *Swaths Management* screen, you can select the *When Logging* option from the *Record Swath* drop-down list:

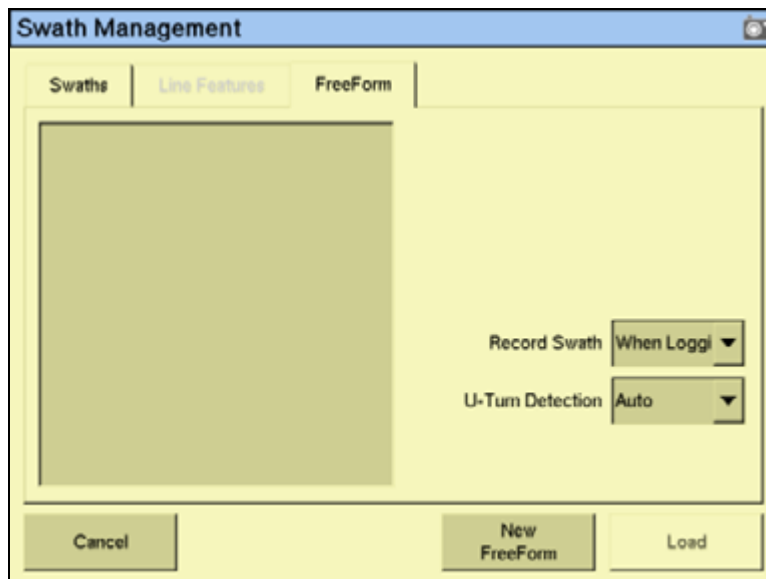

When this option is selected, the system activates FreeForm logging whenever coverage is being logged.

You can simultaneously turn on or off coverage and FreeForm logging with the **Logging** button on the Run screen. Or, if you have an external remote logging switch that controls coverage logging, the system records FreeForm curves when the remote logging switch is enabled (the remote switch turns on coverage, which begins FreeForm logging).

However, if a Field-IQ system is connected, the master switch (on the Field-IQ controller) now controls FreeForm logging and not coverage itself.

*Note* – Coverage switching will not create large numbers of short FreeForm sections.

## Loading a line

To load a line that you previously created in this field:

1. From the Run screen, tap the **Swaths** button. The *Swath Management* screen appears.
2. Do one of the following:
  - To load a straight section, select the appropriate section from the list on the left of the screen.
  - To load a FreeForm curve, select a curve from the list on the left of the screen. The system loads the closest line to you.
3. Tap **Load**. The Run screen appears, with the line loaded.

If you try to load a line that is over 100 km (63 miles) away, the following message appears:

Your current position is too far from the field to work in it.

## Adding an access path

An access path is a space between your guidance lines. They can be useful if there is road (or other field feature that breaks the consistent flow of swaths) through the middle of your field. You can add access paths on a straight or curved pattern, but not headlands or pivots:

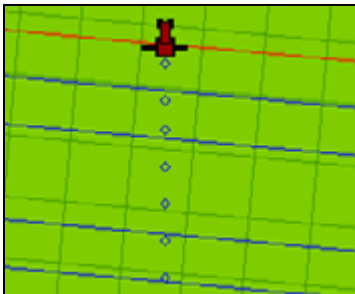

Specify the location and width of the access path when you create the line:

1. From the *Swath Management* screen, tap **Access Paths**:

Field	Value
Swaths between access paths	4
Path width	10' 0.00"
Swaths in first group	4
ABs place in the first group (left to right)	1
Provide Guidance to	Swaths

2. Enter a value in the *Swaths between access paths* field. This value must be equal to or higher than the *Swaths in first group* setting. The next access path will appear this number of swaths beyond the first access path, and will continue to repeat after this number of swaths.

**Note** – You must fill in both of these fields.

3. Enter a value in the *Path width* field. This is the width of the access paths.
4. Enter a value in the *Swaths between access paths* field. The access path will appear after this number of swaths (including the master line).
5. Enter a value in the *ABs place in the first group (left to right)* field. This setting enables you to specify where the master line appears in the first group ( from left to right).
6. Select whether the guidance will be based on swaths or access paths from the *Provide Guidance* to drop-down list and then tap **OK**.

## Swath management

Several options are available on the *Swath Management* screen. You can delete swaths, rename swaths, or shift them to the left or right.

To access these features, select the *Swaths* tab. You cannot delete, rename, or shift line features or FreeForm curves.

### Deleting a swath

To be able to delete swaths, you must have entered the Administration password.

1. From the Run screen, tap the Swath button. The *Swath Management* screen appears.
2. From the list on the left, select the swath to delete.
3. Tap **Delete**. If prompted, enter the password.

The swath is marked as deleted. The next time that you close the field, the swath is removed from the list.

*Note* – You cannot delete a swath that is currently active.

### Renaming a swath

To be able to rename swaths, you must have entered the Administration password.

1. From the Run screen, tap the Swath button. The *Swath Management* screen appears.
2. From the list on the left, select the swath to rename.
3. Tap **Rename**. If prompted, enter the password. The *Enter new swath name* screen appears.
4. Enter the new name for the swath and then tap **OK**.

The swath is renamed.

### Shifting a swath

1. From the *Swath Management* screen, select the swath to shift from the list on the left.
2. Tap **Shift**. The *Enter the Shift Distance* screen appears.
3. Select the correct units for the shift (metric, feet and inches, or rows).
4. Enter the distance to move the swath.
5. Select the direction for the shift. The shift occurs based on the direction of the vehicle, not on the A to B orientation of the line. For example, if you select "Left", the line shifts left of the operator's perspective.

*Note* – If you shift a line, it will shift the original version of the line and remove any skip that you have applied.

6. Tap **OK**. The *Swath Management* screen appears.

The new shifted swath appears in the swath list on the left of the screen.

## Using the "Guide to" tabs

The *Guide to* tabs allow automated steering along a swath, line feature, or FreeForm curve.

To use the Guide to tabs:

1. Tap the **Swaths** button. The *Swath Management* screen appears.
2. From the Guide to tabs, select one of the following:
  - *Swaths* for guidance along a swath.
  - *Line Features* for guidance along a line feature.
  - *FreeForm* for FreeForm curves.
3. If you selected:
  - *Swaths*, select the appropriate swath from the list on the left and then tap **Load**.
  - *Line Features*, guidance automatically occurs on the nearest feature. Tap **Load**. The list shows the types and numbers of line features in the current field.
  - *FreeForm*, select the appropriate FreeForm curve and then tap **Load**.

The Run screen appears. The next time that you engage automated steering, you are guided along the swath, line feature, or FreeForm curve.

## Using Skip to fine-tune navigation

The software uses the original swath that you drove to automatically generate the position of the other swaths. Occasionally, these new on-screen swaths do not perfectly reflect where your swaths are. For example, you may need to skip to the other side of a road.

To correct the spacing of the automatically generated swaths in a field, use the Skip function. After the swaths are generated:

1. From the Run screen, tap .
2. Enter the Skip distance and then tap **OK**. The guidance line moves the required amount. The default distance displayed in the edit box reflects your current position. The shift occurs based on the direction of the vehicle, not on the A to B orientation of the line. For example, if you select "Left", the line shifts left of the operator's perspective.

**Note** – The Skip position is temporary; it is not saved to the line permanently. To save a line adjustment, use the Shift feature. See [Shifting a swath, page 61](#).

## Placing field features on screen

For a description of field features and how to configure the field feature buttons, see [Feature mapping, page 89](#).

For instructions on how to create a separate boundary file that can be used to calculate area and control automatic section switching at the edge of the field, see [Activating field boundaries, page 92](#).

To add a field feature to the map:

1. Select the *Mapping* tab on the Run screen. The features that you defined appear on the tab:

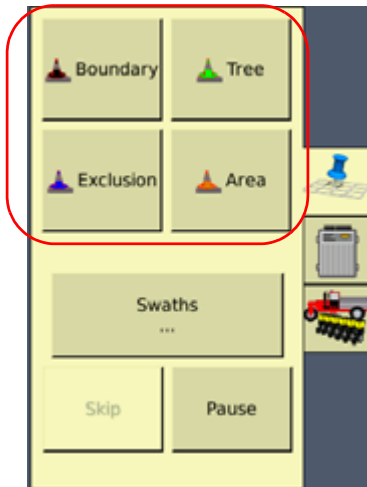

2. Begin to drive the field.
3. When you reach the point where you want to add a feature, tap the appropriate feature button:
  - If the feature is a Point Feature, the feature is added.
  - If the feature is a Line Feature or an Area Feature, the feature will begin. Area and Line features continue until you tap the button a second time.

**Note** – You can add a Point feature *while* adding a Line or Area feature. For example, use a Line feature to draw an overhead telephone wire and simultaneously use a Point feature to add the telephone poles.

## Pausing guidance

You can pause guidance and return to your position later.

To pause guidance, from the Run screen, tap .

When you tap **Pause**, the following happens:

- A pause icon appears at the point where your vehicle was:





- The status text shows the distance and angle required to return to that point.
- Swath snapping occurs to the pause position; it does not follow your vehicle.
- Your position is saved to a file on the display. You can then close the field and turn off the display. When you next open that field, you will be guided back to your former position.

When you return to your former position, tap **Resume**.

## Adjusting the status text size

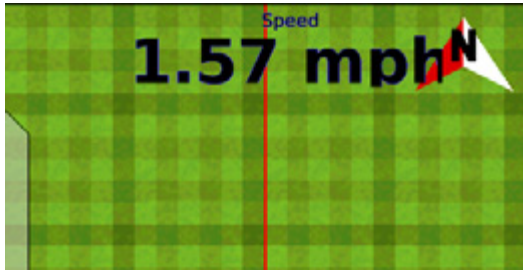
You can control the size of the status text items that are shown at the top of the Run screen. You can show one of the status text items in a large size, or both status text items in a smaller size:

Description	Example
One large status text item	
Two smaller status text items	

To cycle through the status text item display modes, tap the items at the top of the screen.



## Introduction to coverage logging

Coverage logging records the area that you have covered when you carry out an operation, for example applying fertilizer to a field. The covered area appears on the Run screen as a translucent yellow area that shows skips as well as single, double, and triple coverage:

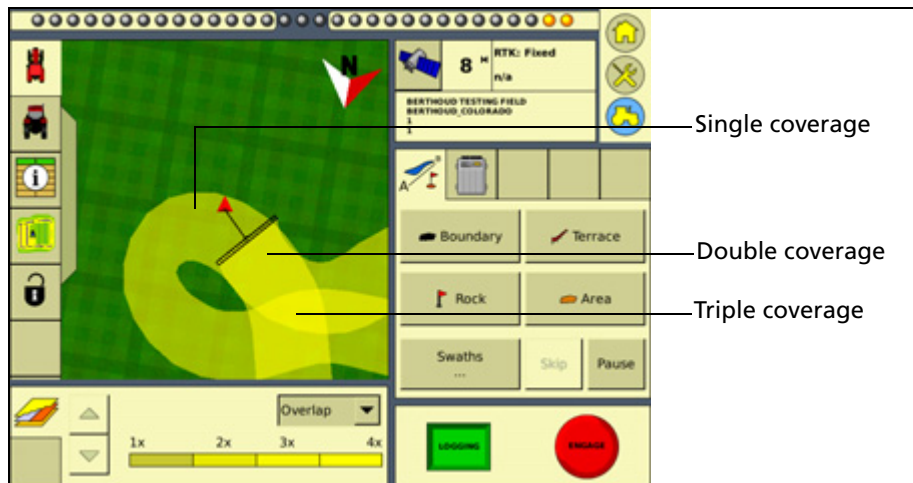

To activate coverage logging, tap the **Logging** button on the Run screen so that it changes from gray to green. Tap the button again to stop coverage logging.

## Logging varieties

By default, coverage logging appears yellow (see above). However, you can set up *varieties* that make it easy to see the difference between different types of coverage:

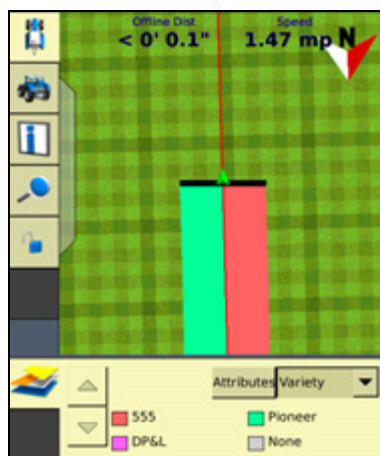

This enables you to:

- Change product part way through a field, so that you can later identify which parts of the field are covered in which product.

- Plant or apply two or more different products side-by-side and record the locations in your field. For example, you could put corn seed in the left side hoppers on your planter and clover seed in the right side hoppers and track where each set of seeds is planted.

The varieties are assigned to rows on your implement. Specify the number of rows on your implement when you configure it. For more information, see [Adjusting the implement settings, page 184](#).

To configure varieties, from the *Field Selection* screen, tap **Hybrid Setup**:

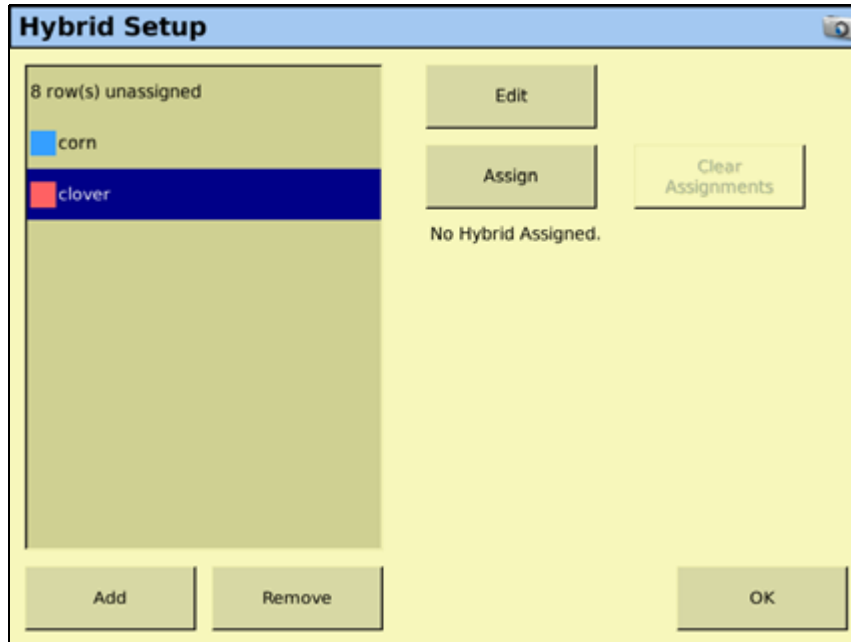

Tap...	To...
<b>Add</b>	Add a new variety and select a name using the virtual keyboard
<b>Remove</b>	Select a variety name in the list and then tap <b>Remove</b> to delete it.
<b>Edit</b>	Select a variety name in the list and then tap <b>Edit</b> to change the settings. Change the color that will appear on the Run screen when you are applying this variety. You can also select record-keeping information.

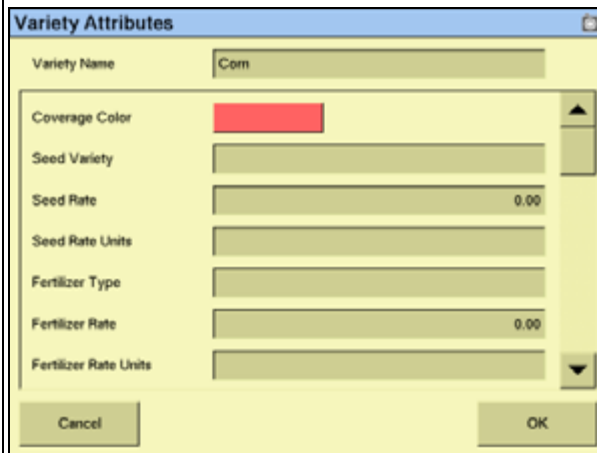

Tap...	To...
<b>Assign</b>	Assign varieties to segments of coverage logging. Select the row numbers on your implement that will be applying each variety. Do this for each variety you have added.
<b>Clear Assignments</b>	Clear all current assignments.

When you enable coverage logging and set the Mapping information tab drop-down list to Variety, this variety color appears in the guidance window. See [page 48](#).



**Tip** – For quick access to the *Hybrid Setup* screen from the Run screen, set the Mapping information tab drop-down list to Variety and then tap **Attributes**.

If you select a different implement or change the settings of the current implement, the variety assignments are removed.

## Prescriptions

You can define variable rate controller setup data, and load prescription files that define the rates to be applied in different areas of the field. This information is used to send target rates to the variable rate controller. Applied rates are received from the controller, and both target and applied rates appear on the screen. In addition, you can log data relating to the variable rate application to the card.

The FmX integrated display can load prescription files created by a Geographic Information System (GIS). The method you use to create the prescription depends on which GIS package you use.

Once you create the prescription, store either the three prescription files in ESRI shape-file format or the single .gdx file in the \AgGPS\Prescriptions\ folder. Then, when you are within the proximity criteria, the prescription is available to load.

When you map a new field or select an existing field, you can also select any shapefile (.shp) or AgInfo GDX (.gdx) prescription file created in AgInfo version 3.5.44.0 or later, that is within the following limits:

For this type of field...	Prescriptions must...
Boundary	Overlap the field boundary
AB Line	Overlap the AB Line
Proximity	Be within 1 km of the field

If you load a shapefile prescription, select the rate column.

If you use complex contoured prescriptions, loading the prescriptions can take some time. The FmX integrated display shows progress bars while it loads and converts prescriptions.

You can configure the status sliders on the main navigation screen (the Run screen) to show the target rate specified in the prescription file, and the applied rates returned from the controller for the active channel.

When a field is open, a prescription is loaded, and a controller is connected, the target rates (read from the prescription) and applied rates (received from the controller) can be shown in the status text items. An example with as-applied rates displayed is shown below:

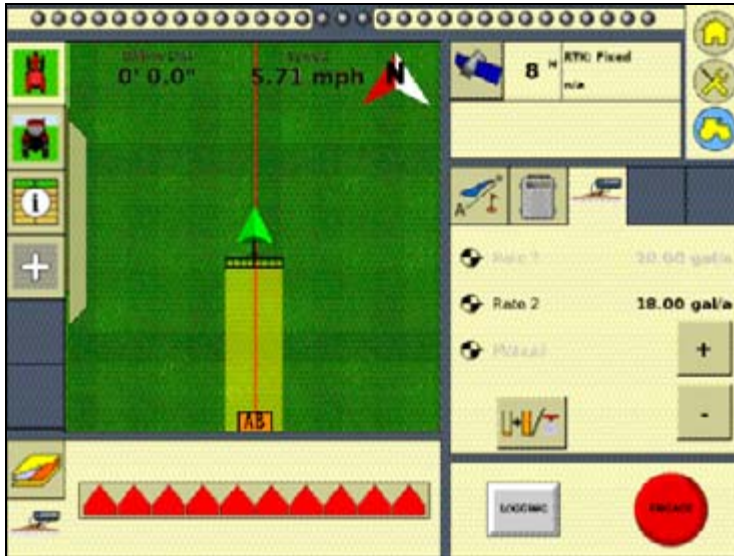

For more information, see [Status items, page 77](#).

To load a prescription file:

1. Map a new field or select an existing field.

The FmX integrated display searches the card for prescription files within the specified limits. If there are many prescriptions on the card, this can take several seconds, and a progress bar appears.

- If any prescription files are within the specified limits, the *Select Prescription* screen appears:

- From the *Available Prescriptions* list, select a prescription file.

**Note** – If an AgInfo GDX prescription has an incorrect format, it does not appear in the *Available Prescriptions* list.

- If you select a shapefile prescription, you must select the correct prescription rate column.



**CAUTION** – When you select a shapefile prescription, if you choose the wrong column when using a variable rate controller, the applied rate will be incorrect.

If you select an AgInfo GDX prescription, the *Rate Column* box does not appear.

- Set the prescription scale factor. Selecting *Prescription Scale Factor* will give a list of scale factors for certain units. Select the scale factor for whatever units are used in the prescription file.
- Set the lead time. See below.
- In the *When off prescription use* list, select the target rate for when you are outside the area that is covered by the prescription file. See [Last, default, or zero rate, page 70](#).
- Tap **OK** to load the prescription file.

A prescription works only when the Field-IQ rate selection switch is in the Rate 1 position. If the switch is in the Rate 1 position, the Increment/Decrement switch is disabled.

If the Rate switch is in the Rate 2 position, the prescription is disabled but the Increment/Decrement switch does work.

### Controller lead time

Lead-time is the average time required by the controller before it can react to a requested rate change. This value can be defined in the *Select Prescription* screen. For example, a value of 5.0 means that, on average, it takes the controller around five seconds to change from one rate to a new rate.

The lead time value is used by the FmX integrated display to project the position of the vehicle into the future. The direction and speed of the vehicle are combined with the lead time to project a future position. The target rate at this projected position is sent to the variable rate controller, giving the controller time to reach the required rate at approximately the same time that the vehicle arrives at the projected position.

You must choose an appropriate lead time. This depends on the controller type and configuration, the type of materials being applied, and the nature and specifications of the delivery equipment.

### Last, default, or zero rate

When the vehicle moves outside the area covered by the prescription file, no target rate is available. There are three options for controlling the output rate:

- Continue to use the last rate being output when the vehicle moves off the prescription
- Use a default rate
- Use a zero rate

Specify the required option in the *Select Prescription* screen.

- Prescriptions can now be selected even when the vehicle is a great distance away from the field, enabling operators or managers to load a prescription before driving to the field:

**Select Prescription**

Prescriptions are assumed by default to be in metric units.  
If your prescription uses Imperial/US units for application rates you must set the scale factor for each channel using the Prescription Scale Factor.

Available Prescriptions

Troy_Pres2.shp	Rate Column	APPLDRATE
	Lead Time	1.00 s
	Prescription Scale Factor	1.00
	When off prescription use	Default Rate

No Prescription      OK

# Display Setup

## In this chapter:

- Accessing the system configuration settings
- Configuring the display

This chapter describes how to configure the basic settings and appearance the display.

***Note** – Some configuration settings are unavailable when a field is open in the Run screen. To access these settings, return to the Run screen and then tap the **Home** button. When prompted to close the field, tap **Yes**.*

## Accessing the system configuration settings

To configure the system settings, do the following:

1. From the Home screen, tap .
2. Tap **Configure**.

The *Configuration* screen appears, with the currently installed plugins listed on the left of the screen:

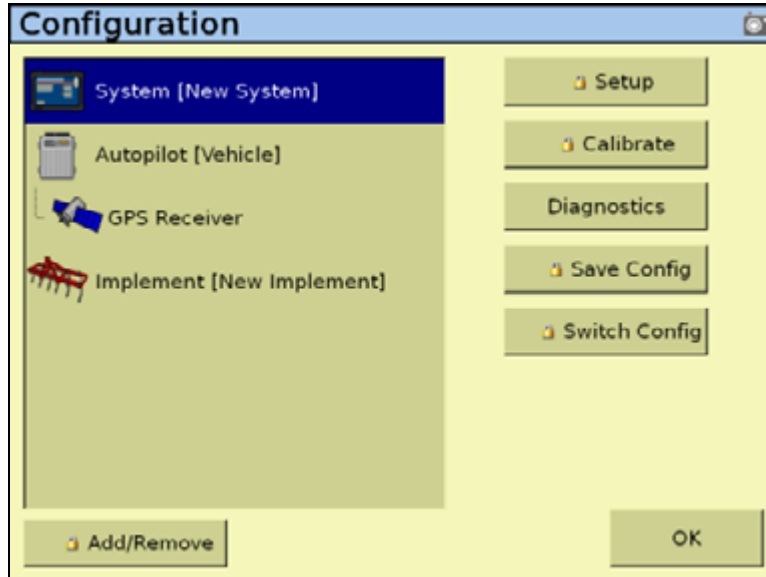

3. Tap *System* and then tap one of the following:

Tap ...	To ...
<b>Setup</b>	Set up the system. See <a href="#">Configuring the display, page 73</a> .
<b>Calibrate</b>	<p>Calibrate the touchscreen so that it reads your selections accurately. The FmX integrated display ships with the touchscreen already calibrated.</p> <p> <b>CAUTION</b> – Do not use a sharp item, such as a pencil, to press the touchscreen, as you may damage the surface of the screen. Use your finger to press the screen.</p>
<b>Diagnostics</b>	<p>View information about:</p> <ul style="list-style-type: none"> <li>• Serial Communications</li> <li>• CAN Bus</li> <li>• System Information</li> <li>• Advanced</li> <li>• Power Levels</li> <li>• CPU</li> </ul>
<b>Save Config</b>	Save the current system configuration.
<b>Switch Config</b>	Switch to a saved system configuration.



## Password access

Any **Setup** or **Calibrate** button marked with a padlock icon  is protected by two passwords:

Password type	Description
Administration password	Your password. The default is "2009".
Master password	A backup password in case you lose the Administration password. If you require the Master password, contact your local reseller.

The password screen appears the first time that you tap a **Setup** or **Calibrate** button after you turn on the display. Use the virtual keyboard to enter the Administration password and then tap **OK**.

*Note – Passwords are case sensitive.*

## Configuring the display

1. In the *Configuration* screen, select the System option and then tap **Setup**.
2. If necessary, enter the Administrator password. See [Password access, page 73](#).

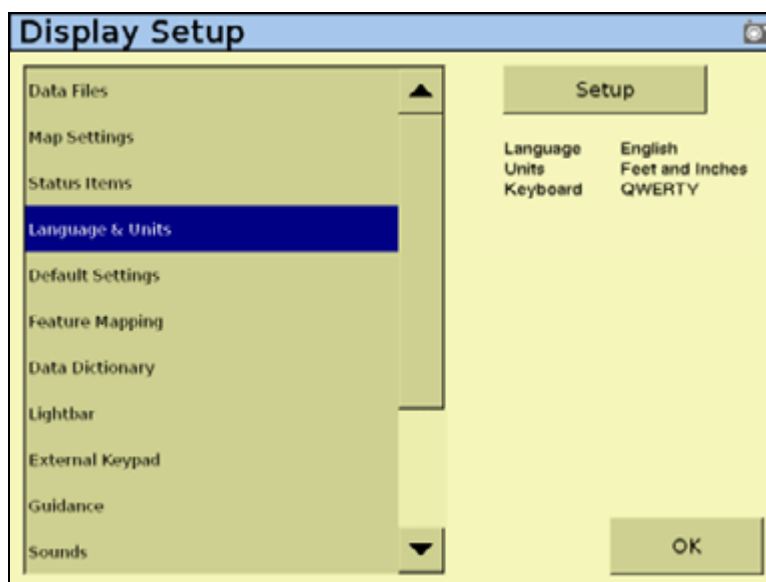

In the *Display Setup* screen, you can configure:

- Display preferences
  - Map settings (including Night-mode)
  - Status item configuration
  - Language and units (including keyboard layout) setup
  - Default settings

- Mapping preferences
  - Feature mapping configuration
  - Data dictionary editor
  - Data files management (this appears at the top of the *Display Setup* list)
- Display options
  - External lightbar setup
  - Guidance setup
  - Sound settings
- Hardware configuration
  - CAN bus settings
  - Power management setup
  - Time zone configuration
  - External keypad

These steps are described in more detail in the following sections.

## Data Files

The *Data Files* management screen enables you to manipulate your saved data.

From either the display's internal memory or the USB memory stick, you can copy implements, prescriptions, data dictionaries, field data, or delete unwanted data.

For more information, see [Copying or deleting data files, page 485](#).

## Map Settings (including night-mode)

The *Mapping* screen has two tabs that enable you to configure various settings for the FmX integrated display.

### The Main tab

The *Main* tab includes the following options:



Item	Description
Map orientation	Controls the direction that the screen follows the position of the vehicle.
Color scheme	Selects either the default or night-mode color scheme. The night-mode color theme uses darker color themes to cause less eye strain in low light conditions.
Save summaries	On: Create a save file for your work. Off: Do not create a save file for your work.

To configure the settings in the *Main* tab, do the following:

1. In the *Display Setup* screen, select *Map Settings*:

 **Tip** – For a new toolbar orientation to take effect, restart the FmX integrated display.

2. Select your preferred map orientation in the *Map Orientation* drop-down list:

Map orientation	Example of view	Description
North Up		When you perform a turn, the field remains stationary and the vehicle turns.
Vehicle Up		When you perform a turn, the field rotates but the vehicle remains pointing up.

 **Tip** – To change the map orientation from the Run screen, tap the north arrow.

3. Select the color scheme from the *Color Scheme* drop-down list:



4. To create a save file for your work, select On from the *Save Summaries* drop-down list.

## Track Logging tab

The *Track Logging* tab includes options to record the vehicle track at either a set time or a set distance.

Points along the track are logged at the greater of the two values (logging time or logging distance).

To always log a point based on either of the two values, set the other value to zero. Setting both values to zero disables Track Logging:

Setting	Description
Distance = 0, Time = 0	Track logging is turned off.
Distance = 1+, Time = 0	Track logging is recorded by distance (m).
Distance = 0, Time = >1+	Track logging is recorded by time (s).
Distance = >1+, Time = >1+	Track logging is recorded by whichever setting is higher.

## Track logging files

Track logging files are created whenever you open an event. The track file records points at the rate defined in the *Mapping* screen (see the previous section). At each point, a number of attributes are recorded.

The data stored in the track logging file (Track3D\_<date time>.dbf) is in metric units.

The information stored for each point in the track logging file is as follows:

Column	Field description	Units
Version	Track attribute file version.	–
UTC_Date	Point creation date.	YYYYMMDD
UTC_Time	UTC time.	hh:mm:ss.s
Local_Time	Local time.	hh:mm:ss.s
Logging_On	Coverage logging flag (1=on, 0=off).	On or off
Auto_Steer	Auto-Steer flag (1=on, 0=off).	On or off
GPS_Status	GPS status value (NMEA).	1, 2, 5, 4
Status_Text	GPS status description.	–
Num_Stats	Number of GPS satellites.	–
HDOP	Horizontal Dilution of Precision – A measure of the quality of positions based on satellite geometry.	–
Corct_Age	DGPS signal correction age.	seconds
Ant_Lat	Antenna latitude (WGS-84).	DD.dddddddd
Ant_Long	Antenna longitude (WGS-84).	DD.dddddddd
Height	Mean sea level height of ground.	meters
Ant_HAE	Antenna height above ellipsoid. <b>Note – Attribute Not Populated.</b>	meters
Ground_HAE	Ground height above ellipsoid. <b>Note – Attribute Not Populated</b>	meters
Speed	GPS-derived ground speed.	kph

Column	Field description	Units
Heading	Direction of travel with respect to true North.	decimal degrees
Swath_Num	Current swath/headland number.	
Offline	Offline distance from swath center line.	meters
Along_Line	Along line distance from start of swath. <b>Note – Attribute Not Populated</b>	meters
Swath_Wdth	Swath width.	meters
Appln_Wdth	Application width.	meters
Units	Units. <b>Note – Attribute Not Populated</b>	metric
Field_Name	The name of the field.	–
Target	The target rate at the current position.	–
As_Applied	Applied rate. <b>Note – Attribute Not Populated</b>	–
Pitch	The pitch. <b>Note – Attribute Not Populated</b>	–
Roll	The roll. <b>Note – Attribute Not Populated</b>	–
Yaw	The yaw. <b>Note – Attribute Not Populated</b>	–
Total_Qty	Total volume of material as applied for the current field. Only supported for the Aerial Flow Controller, Autocal Flow controller, and Crophawk Flow Meter.	–
Relative_Height	Height.	meters

## Status items

The *Status items* are segments of information that can be displayed on the Run screen. The information appears in three different locations:

- In two locations at the top of the screen.
- On a slide-out tab at the left of the screen.

The slide-out tab overlies the main screen, but is transparent so that you can still see guidance underneath it. To extend the slide-out tab, tap the end of the tab on the left of the screen.

The slide-out tabs automatically slide back in when the specified time-out value is reached. To close the tab before then, tap the tab.

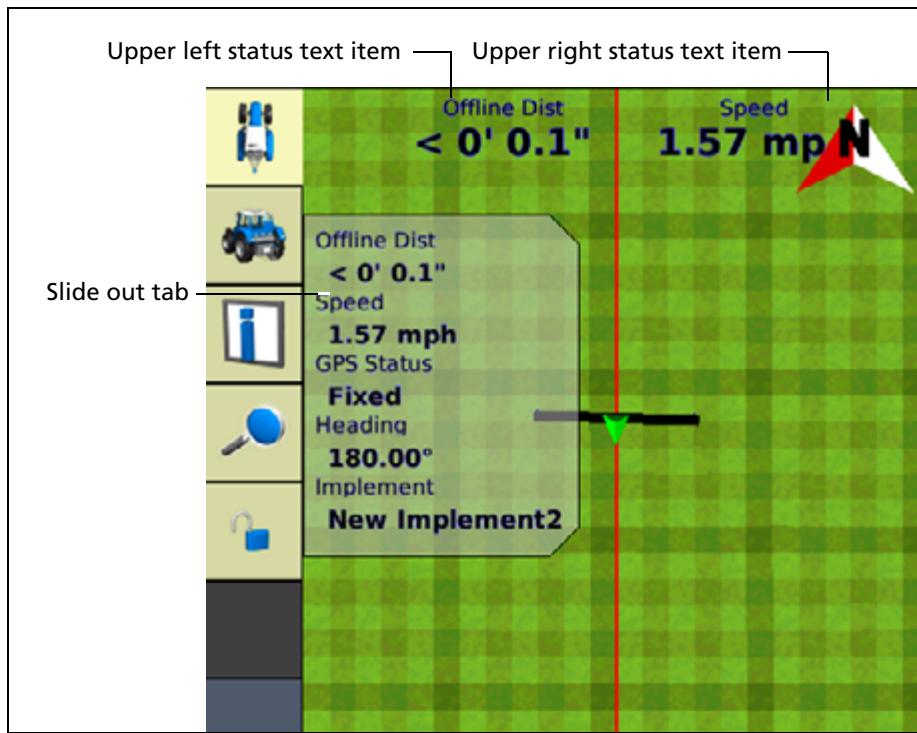

To access the Info screen, tap :

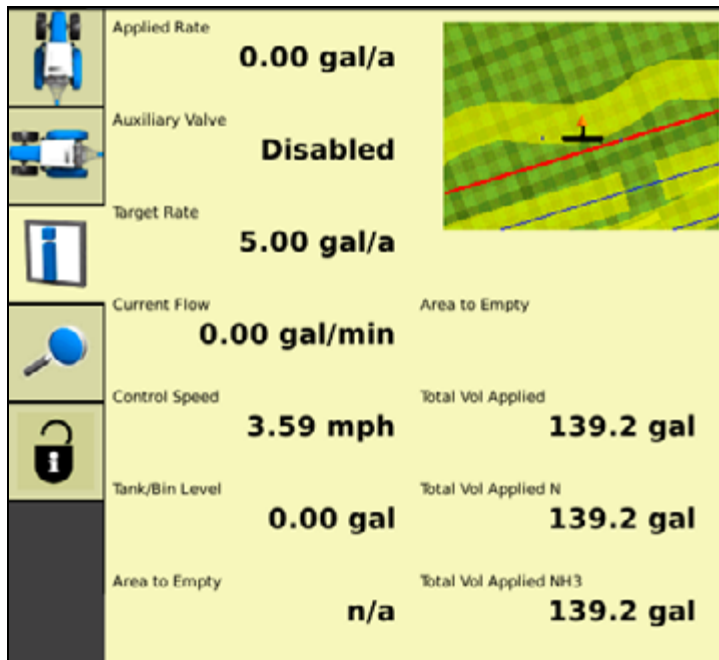

To configure which status text items appear on the Info screen, see [Status items, page 79](#).

## Status items

The status items are ordered by plugin. If a plugin is removed, the items associated with it are no longer available. The available items are as follows (shown in alphabetic order).

Item	Description
(blank)	The status text item is not shown.
Altitude	The current height of the vehicle.
Applied Rate	The current application rate.
Area to Empty	The area that can still be applied before the tank is empty.
Auxiliary Valve	The current status of the auxiliary valve.
Available Memory	The amount of free space on the display's internal memory.
Average Population	The average rate across all rows.
Avg Seed Spacing	The average distance between seeds based on the average sample size.
Blade Height	The current height of the blade.
Boot Depth	The depth of the boot when installing tiles or the depth of the blade when cleaning surface ditches (used with the Autoslope leveling model).
CH1 - CH4 Product Level	The current level of the products that are in channels 1-4.
Client Name	Name of the current client.
CMR Percent	The percentage of radio CMR packets received over the last 100 seconds.
Control Speed	The speed reported to the multi-application controller.
Correction Age	The length of time since the last correction was received.
Correction Type	The correction type that is being used.
Coverage Percent	The percentage of the field area that is covered area.
Current Flow	The current flow of material.
Cut/Fill	The difference between the Blade Height and the Target Height: <ul style="list-style-type: none"> <li>When Cut is shown, the current ground height is above the target height. The height adjustment indicator shows a red down arrow, which means that the blade needs to move down to reach the Target Height.</li> <li>When Fill is shown, the current ground height is below the target height. The height adjustment indicator shows a red up arrow, which means that the blade needs to move up to reach the Target Height.</li> </ul>
Design Height	The height the blade will attempt to reach. This is the Design Height $\pm$ the Offset. When the blade reaches the Target Height, the arrows turn green.
Design Slope	When using the Autoslope leveling model, this displays the design slope with respect to the current location along the section line.
Dist to Feature	The distance to the nearest feature.
Dist to Pause	The distance to the pause position.
East	The distance that the vehicle is to the east of the field origin point (a negative number means the vehicle is to the west of the field origin point).
Engaged Time	The length of time that the system has been engaged.
Event Coverage Area	The area that has been logged during the current event.
Event Coverage Distance	The distance covered while logging during the current event.
Event Coverage Time	The length of time that coverage logging has been engaged during the current event.
Event Name	Name of the current event.

Item	Description
Farm Name	Name of the current farm.
Field Area	The field area within a pivot or headland boundary.
Field Name	Name of the current field.
Free External Storage	The amount of free space on the USB memory stick.
Free Internal Storage	The amount of free space on the display's internal memory.
GMT Time	The current Greenwich Mean Time.
GPS Position Spacing	
GPS Status	The GPS correction type that the GPS receiver is currently using.
H Error	(Horizontal error) An estimation of the level of precision of the GPS position in 2 dimensions.
Heading	The current heading of the vehicle, in degrees, from direct north.
Heading to Feature	Vehicle location relative to the nearest feature (feature is directly ahead = 0°; directly behind = 180°).
Heading to Pause	Direction vehicle is facing relative to the paused vehicle position (directly ahead = 0°; directly behind = 180°).
Impl. Altitude	The current height of the implement.
Impl. CMR Percent	The percentage of radio CMR packets received by the implement GPS receiver over the last 100 seconds.
Impl. Correction Age	The age of the corrections used by the implement receiver.
Impl. Correction Type	The correction type used by the implement receiver.
Impl. East	The distance that the implement is to the east of the field origin point (a negative number means the implement is to the west of the field origin point).
Impl. Engaged Time	The time that the implement has been engaged.
Impl. GPS Status	The status of the GPS correction used for the implement.
Impl. H Error	(Horizontal error) An estimation of the level of precision of the implement GPS position in 2 dimensions.
Impl. HDOP	The Horizontal Dilution of Precision of the implement receiver: A measure of accuracy based on the geometry of the satellites in the sky. If the satellites are near each other in the sky, the HDOP is higher (lower is better).
Impl. Heading	The current heading of the implement, in degrees, from direct north.
Impl. Latitude	The implement's current latitude.
Impl. Long-Term XTE	An implement Cross Track Error (XTE) when passes occur more than one hour apart.
Impl. Longitude	The implement's current longitude.
Impl. Network ID	The RTK network ID of the implement receiver's corrections.
Impl. North	The distance that the implement is to the north of the field origin point (a negative number means the implement is to the south of the field origin point).
Impl. Nudge/Trim	The amount of nudge or trim currently applied to the implement position.
Impl. Offline Dist	The distance away from the guidance line.
Impl. Satellites	The number of satellites the implement receiver is reading.
Impl. Short-term XTE	An implement pass-to-pass Cross Track Error (XTE) when passes occur within less than 15 minutes.
Impl. Speed	The current implement speed.
Impl. Steering Angle	The steering angle of the implement.
Impl. Up	The vertical height of the implement relative to the field origin point (a negative number means the implement is lower than the field origin point).



Item	Description
Impl. Vehicle Model	The implement profile name.
Implement	The name of the current implement.
Implement F/B Offset	Distance of front to back offset.
Implement L/R Offset	Distance of left to right offset.
Implement Width	Width of the implement.
Latitude	The vehicle's current latitude.
Line Feature Length	The length of the current line feature.
Local Time	The current local time.
Long-term XTE	A vehicle Cross Track Error (XTE) when passes occur more than one hour apart.
Longitude	The vehicle's current longitude.
NDVI	Normalized Difference Vegetation Index.
Nearest Point Name	The name of the nearest point feature.
Network ID	The RTK network ID of the GPS receiver's corrections.
Network Status	The current status of the wireless cellular network.
North	The distance that the vehicle is to the north of the field origin point (a negative number means the vehicle is to the south of the field origin point).
Nudge	The amount of nudge currently applied.
Nudge/Trim	The amount of nudge or trim currently applied.
Offline Dist.	The distance away from the guidance line.
Offset X	The Relative Position X offset from the master benchmark.
Offset Y	The Relative Position Y offset from the master benchmark.
P Altitude	The current height of the vehicle as reported by the primary blade GPS receiver.
P Blade Height	The current height of the primary blade.
P Boot Depth	The depth of the boot when installing tiles or the depth of the blade when cleaning surface ditches (used with the Autoslope leveling model).
P CMR Percent	The percentage of radio CMR packets received over the last 100 seconds by the primary blade GPS receiver.
P Correction Age	The time since the GPS corrections were last received from the primary FieldLevel GPS receiver.
P Correction Type	The correction type used by the primary blade receiver.
P Cut/Fill	The difference between the Primary Blade Height and the Primary Target Height: <ul style="list-style-type: none"> <li>• When Cut is shown, the current ground height is above the target height. The height adjustment indicator shows a red down arrow, which means that the blade needs to move down to reach the Target Height.</li> <li>• When fill is shown, the current ground height is below the target height. The height adjustment indicator shows a red up arrow, which means that the blade needs to move up to reach the Target Height.</li> </ul>
P Design Height	The height the primary blade will attempt to reach. This is the Design Height $\pm$ the Offset. When the blade reaches the Target Height, the arrows turn green.
P Design Slope	When using the Autoslope leveling model, this displays the design slope with respect to the current location along the section line.
P Distance Traveled	(For use with FieldLevel II Point to Slope mode). The distance traveled since Auto mode was enabled.
P East	The distance that the primary blade receiver is to the east of the field origin point (a negative number means the receiver is to the west of the field origin point).

Item	Description
P GPS Status	The GPS correction type that the primary blade GPS receiver is currently using.
P H Error	(Horizontal error) An estimation of the level of precision of the primary blade GPS position in 2 dimensions.
P HDOP	The Horizontal Dilution of Precision of the primary blade receiver: A measure of accuracy based on the geometry of the satellites in the sky. If the satellites are near each other in the sky, the HDOP is higher (lower is better).
P Heading	The current heading of the primary blade, in degrees, from direct north.
P Latitude	The primary blade's current latitude.
P Longitude	The primary blade's current longitude.
P Network ID	The RTK network ID of the primary blade receiver's corrections.
P North	The distance that the primary blade receiver is to the north of the field origin point (a negative number means the receiver is to the south of the field origin point).
P Offset	A separate plane that is parallel to the design plane. The offset is defined by a single measurement, which is the height that the offset plane is from the design plane.
P Offset X	The Relative Position X offset from the master benchmark.
P Offset Y	The Relative Position Y offset from the master benchmark.
P Satellites	The number of satellites the system is currently being received by the FieldLevel II GPS receiver.
P Section Line Number	The line number of the primary blade.
P Speed	The speed of the vehicle as reported by the primary blade GPS receiver.
P Target Height	The height the primary blade will attempt to reach. This is the Design Height $\pm$ the Offset. When the blade reaches the Target Height, the arrows turn green.
P Up	The height of the primary blade receiver relative to the field origin point (a negative number means the blade is lower than the field origin point).
P VDOP	The Vertical Dilution of Precision of the FieldLevel II GPS receiver: A measure of accuracy based on the geometry of the satellites in the sky. If the satellites are near each other in the sky, the VDOP is higher (lower is better).
P Vertical Error Estimate	The current estimate of error in the height calculated by the FieldLevel II GPS receiver.
Pressure	The current pressure, as reported by the primary pressure sensor.
Productive Area	The area of Area Features that are designated as "productive".
Radio Signal Strength	The DCM-300 wireless signal strength.
S Altitude	The current height of the vehicle as reported by the secondary blade GPS receiver.
S Blade Height	The current height of the secondary blade.
S CMR Percent	The percentage of radio CMR packets received over the last 100 seconds by the secondary blade GPS receiver.
S Correction Age	The time since the GPS corrections were last received from the secondary FieldLevel GPS receiver.
S Correction Type	The correction type used by the secondary blade receiver.

Item	Description
S Cut/Fill	The difference between the Secondary Blade Height and the Secondary Target Height: <ul style="list-style-type: none"> <li>• When Cut is shown, the current ground height is above the target height. The height adjustment indicator shows a red down arrow, which means that the blade needs to move down to reach the Target Height.</li> <li>• When Fill is shown, the current ground height is below the target height. The height adjustment indicator shows a red up arrow, which means that the blade needs to move up to reach the Target Height.</li> </ul>
S Design Height	The height the secondary blade will attempt to reach. This is the Design Height $\pm$ the Offset. When the blade reaches the Target Height, the arrows turn green.
S Distance Traveled	(For use with FieldLevel II Point to Slope mode). The distance traveled since Auto mode was enabled.
S East	The distance that the secondary blade receiver is to the east of the field origin point (a negative number means the receiver is to the west of the field origin point).
S GPS Status	The GPS correction type that the secondary blade GPS receiver is currently using.
S H Error	(Horizontal error) An estimation of the level of precision of the secondary blade GPS position in 2 dimensions.
S HDOP	The Horizontal Dilution of Precision of the secondary blade receiver: A measure of accuracy based on the geometry of the satellites in the sky. If the satellites are near each other in the sky, the HDOP is higher (lower is better).
S Heading	The current heading of the secondary blade, in degrees, from direct north.
S Latitude	The secondary blade's current latitude.
S Longitude	The secondary blade's current longitude.
S Network ID	The RTK network ID of the secondary blade receiver's corrections.
S North	The distance that the secondary blade receiver is to the north of the field origin point (a negative number means the receiver is to the south of the field origin point).
S Offset	A separate plane that is parallel to the design plane. The offset is defined by a single measurement, which is the height that the offset plane is from the design plane.
S Offset X	The Relative Position X offset from the master benchmark.
S Offset Y	The Relative Position Y offset from the master benchmark.
S Satellites	The number of satellites the system is currently being received by the FieldLevel II GPS receiver.
S Section Line Number	The line number of the secondary blade.
S Speed	The speed of the vehicle as reported by the secondary blade GPS receiver.
S Target Height	The height the secondary blade will attempt to reach. This is the Design Height $\pm$ the Offset. When the blade reaches the Target Height, the arrows turn green.
S Up	The height of the secondary blade receiver relative to the field origin point (a negative number means the blade is lower than the field origin point).
S VDOP	The Vertical Dilution of Precision of the FieldLevel II GPS receiver: A measure of accuracy based on the geometry of the satellites in the sky. If the satellites are near each other in the sky, the VDOP is higher (lower is better).
S Vertical Error Estimate	The current estimate of error in the height calculated by the FieldLevel II GPS receiver.
Satellites	The number of satellites the system is currently receiving.
Secondary Pressure	The current pressure, as reported by the secondary pressure sensor.

Item	Description
Section Line Number	The number of the current section line.
Seed Mults %	The percentage of time an more than one seed is placed for every intended drop.
Seed Population	The amount of seed planted per acre/hectare.
Seed Singulation	The percentage of time an individual seed is placed for every intended drop.
Seed Skips %	The percentage of seed that has not been planted.
Seed Spacing	The percentage of seed that has been applied in the specified spacing.
Session Coverage Area	The area that has been logged during the current session.
Session Coverage Dist	The distance covered while logging during the current session.
Session Coverage Time	The length of time that coverage logging has been engaged during the current session.
Session Time	The length of the current field session.
Short-term XTE	A vehicle pass-to-pass Cross Track Error (XTE) when passes occur within less than 15 minutes.
Speed	The current vehicle speed.
Steering Angle	The angle reported by the rotary potentiometer or the AutoSense™ device.
Survey Area	The total area of the current survey.
Survey Cut/Fill	"The difference between the Blade Height and the Target Height: <ul style="list-style-type: none"> <li>• When Cut is shown, the current ground height is above the target height. The height adjustment indicator shows a red down arrow, which means that the blade needs to move down to reach the Target Height.</li> <li>• When Fill is shown, the current ground height is below the target height. The height adjustment indicator shows a red up arrow, which means that the blade needs to move up to reach the Target Height.</li> </ul>
Survey Points	The number of survey points that have been created.
Swath Length	The length of the current guidance line. Note - FreeForm™ curves are made up of line segments, so the Swath Length value is not appropriate for FreeForm curves.
Swath Number	The swath number (L = left, R = right). Note - FreeForm curves are made up of line segments, so the Swath Number value is not appropriate for FreeForm curves.
Swath Points	The number of points that define the current line.
Tank Level	The current level of the tank.
Tank Level N	The level of nitrogen currently in the tank.
Tank Level NH3	The level of anhydrous ammonia currently in the tank.
Tank/Bin Level	The current level of the tank or bin.
Target Rate	The application target rate.
Total Boundaries Area	The total area between the current boundaries.
Total Seed Rate	The total seed rate that is currently being applied.
Total Vol Applied	The total volume of material applied.
Total Vol Applied N	The total volume of nitrogen applied.
Total Vol Applied NH3	The total volume of anhydrous ammonia applied.
Transfer Status	Connected Farm transfer activity.
TrueGuide Roll	Roll corrections in degrees that are applied.
TrueGuide Trim	The distance from the guidance line that the vehicle has been shifted.
Up	The vertical height of the vehicle relative to the field origin point (a negative number means the vehicle is lower than the field origin point).

Item	Description
VDOP	The Vertical Dilution of Precision of the FieldLevel II GPS receiver: A measure of accuracy based on the geometry of the satellites in the sky. If the satellites are near each other in the sky, the VDOP is higher (lower is better).
Vehicle Model	The model of vehicle that is configured.
Vehicle Type	The type of vehicle that is configured.
Vertical Error Estimate	The current estimate of error in the height calculated by the FieldLevel II GPS receiver.

In the *Display Setup* screen, select **Status Items** and then tap *Setup*:

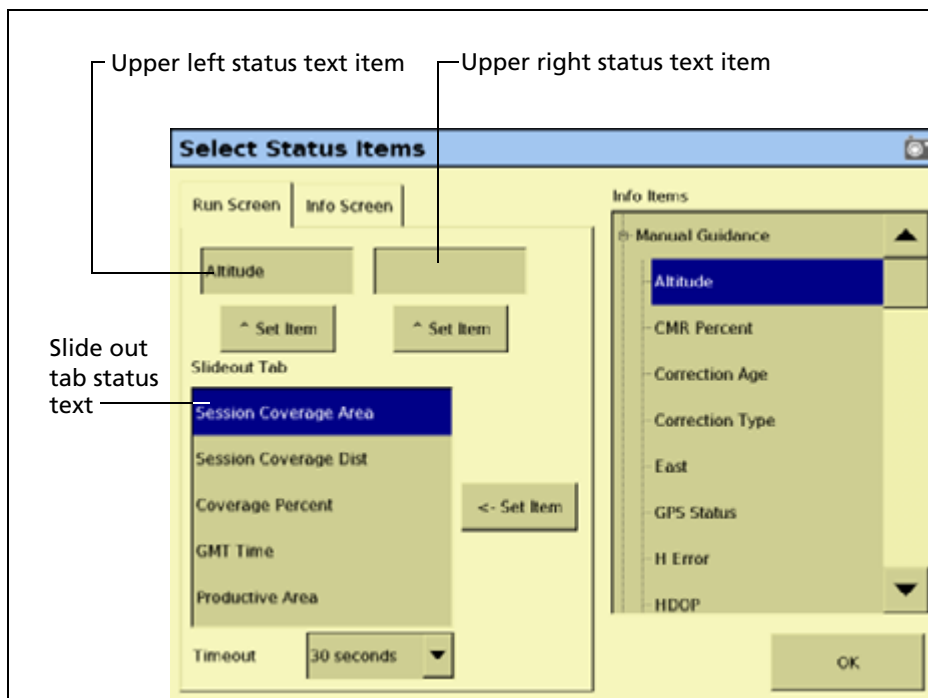

The *Select Status Items* screen has two tabs that enable you to configure various display options for the status text items.

### The Run Screen tab

The *Run Screen* tab lets you allocate the various items that will be displayed on the Run screen.

The status text items appropriate for your current plugins appear in the *Info Items* list.

1. Set the upper left status text item:
  - a. In the *Info Items* list, tap the item you want to use.
  - b. Tap the left **^ Set Item** button.

The information appears in the upper left field.

2. Set the upper right status text item:

- a. In the *Info Items* list, tap the item you want to use.
- b. Tap the right **^ Set Item** button.

The information appears in the upper right field.

- 3. In the *Timeout* list, select a time. This is how long the tab remains on-screen before retracting. To have the tab extended until you close it manually, select *Never*.
- 4. To add status items to the slide-out tab:
  - a. Tap the position on the tab that you want to fill. For example, to add an item to the first position on the list, tap at the location shown:

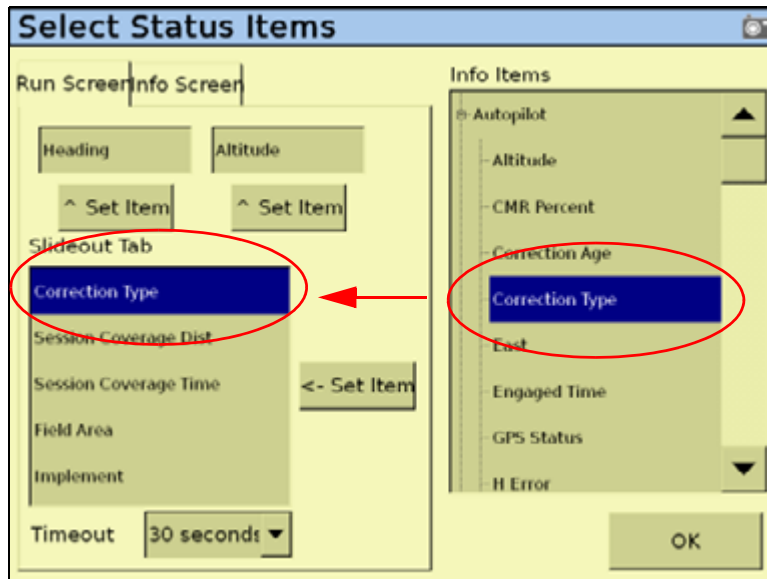

- b. In the *Info Items* list, tap the item you want to use.
- c. Tap **<- Set Item**.
- d. To save the configuration, tap **OK**.

## The Info Screen tab

The *Info Screen* tab lets you allocate which items will be displayed on the Info screen.

The status text items appropriate for your current plugins appear in the *Info Items* list.

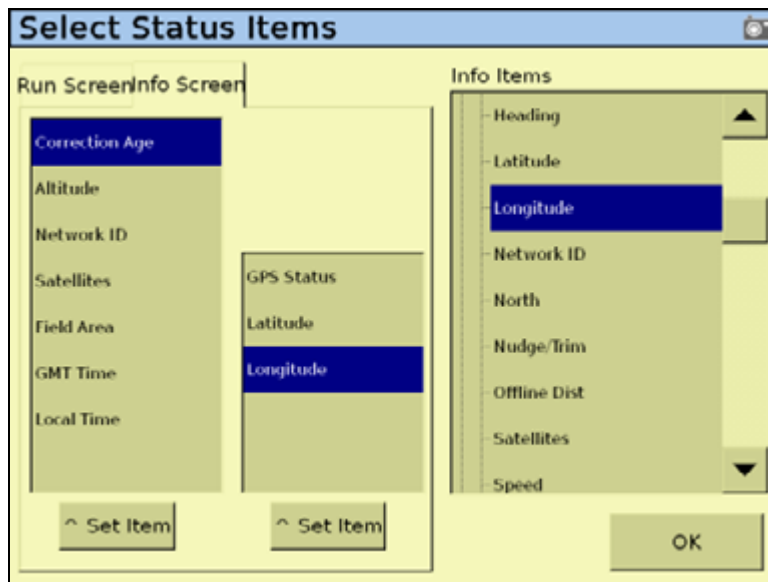

1. Set the left Info text items:
  - a. In the *Info Items* list, tap the item you want to use.
  - b. Tap the left **^ Set Item** button.
  - c. Repeat Step a and Step b until you have all the items you require, or the list is full.  
The information appears in the left field.
2. Set the right Info text items:
  - a. In the *Info Items* list, tap the item you want to use.
  - b. Tap the right **^ Set Item** button.
  - c. Repeat Step a and Step b until you have all the items you require, or the list is full.  
The information appears in the right field.
  - d. To save the configuration, tap **OK**.

## Selecting the language, units of measure, and keyboard layout

To select the default language for the display:

1. In the *Display Setup* screen, select *Language & Units* and then tap **SETUP**. The *Language & Units* setup screen appears:

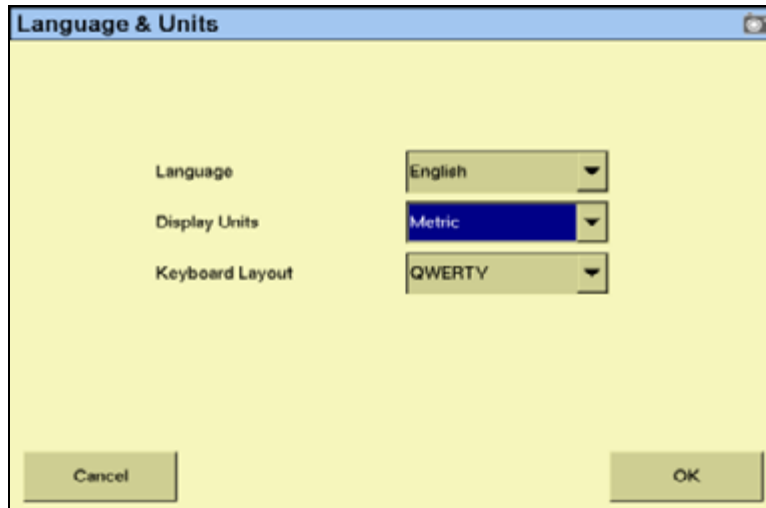

2. Select the language to use from the *Language* drop-down list.

If you change the language, a message warns that the display will turn off so that the change can take effect.

The default language is English.

3. To select the unit of measure for the display, select the preferred option from the *Display Units* drop-down list:

- Metric
- Feet and Inches
- Decimal Feet

The default option is Feet and Inches.

4. Set the keyboard layout.

The FmX integrated display uses a virtual keyboard on the touch screen for you to enter characters (see [page 25](#)).

The virtual keyboard can be laid out in two ways:

Setting	Description
ABCDEF	The letters appear in alphabetical order.
QWERTY	The keyboard is laid out like the QWERTY keyboard on a computer.

Select your preferred option from the *Keyboard Layout* drop-down list.

The default option is ABCDEF.



## Default settings

To restore the settings of the FmX integrated display to the factory default settings, select *Default Settings* and then tap **Restore**.

## Feature mapping

- From the *Display Setup* screen, select **Feature Mapping** and then tap **Setup**:

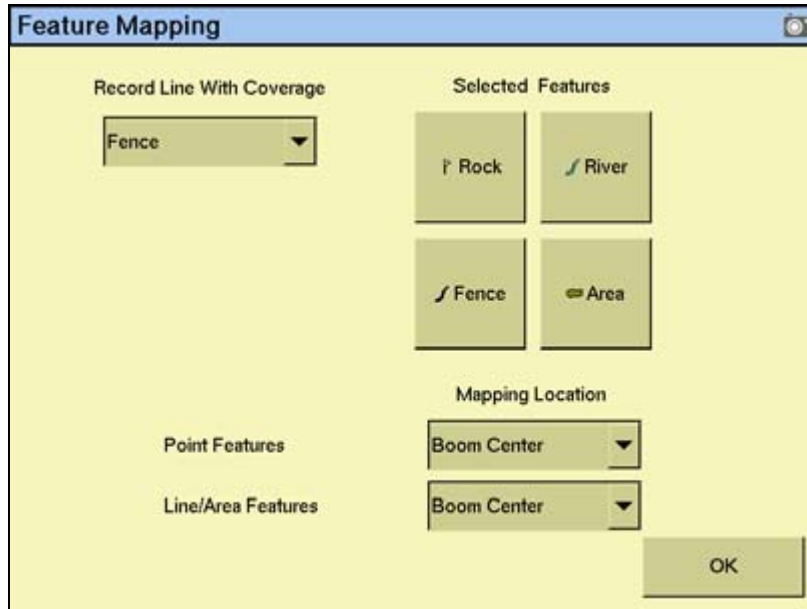

The four large buttons represent the field feature buttons that appear on the *Mapping* tab on the Run screen (see [The Run screen layout, page 45](#)).

- In the *Mapping Location* group, select *Boom Left*, *Boom Center*, or *Boom Right* as the point on the vehicle where the feature will be created:
  - For a Point feature, select from the *Point Features* drop-down list.
  - For a Line or Area feature, select from the *Line/Area Features* drop-down list.

3. Select one of the four feature buttons to assign a feature to:

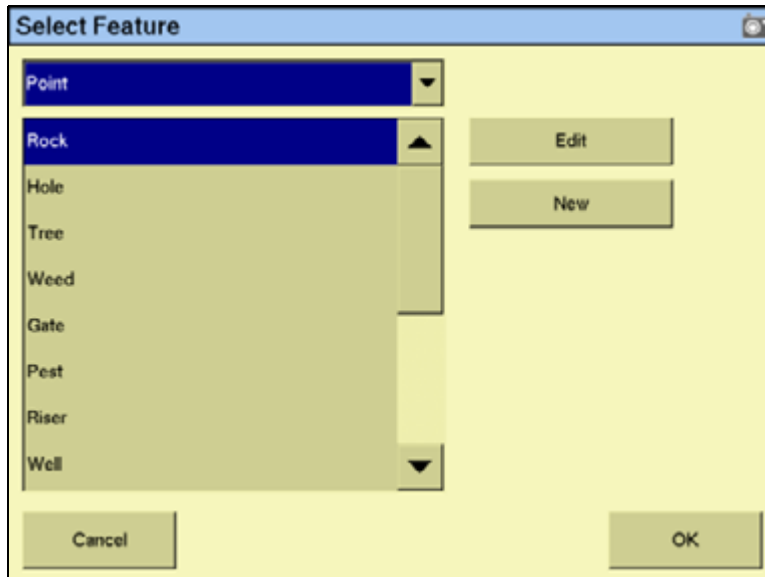

4. Do one of the following:
  - To create a new feature and assign it to the button, select the type of feature to create (point, line, or area) from the drop-down list and then tap **New**. The *Edit Feature* screen appears.
  - To assign an existing feature to the button, select the type of feature to edit (point, line, or area), select the feature from the list that appears and then tap **OK**. The *Select Active Feature* screen reappears with the feature that you selected assigned to the feature button.

### Creating a point feature

1. Enter values for the following settings.

Item	Description
Name	The name of the feature. For example, "Tree".
Alarm Radius	When the vehicle comes within this radius of the feature, the alarm appears. The alarm radius appears on the screen as a solid red block of color. The alarm radius is more serious than the warning radius, so set it to a shorter distance.
Warning Radius	The distance around the feature that causes a warning message to appear. The warning radius appears on the screen as an orange line.
Average Position	This is a way to improve the quality of the point feature position. <ul style="list-style-type: none"> <li>• If you click <b>Yes</b>, the display calculates the average position of the feature over 30 seconds.</li> <li>• If you click <b>No</b>, the display places the feature at the coordinates that the vehicle is at when you tap the button.</li> </ul>

2. To select the feature appearance color, tap **Color**.

3. To return to the *Select Feature* screen, tap **OK**.  
The new feature appears in the *Point* list.
4. Select the new feature from the list and then tap **OK**.  
The new feature appears on the button you selected.
5. To exit, tap **OK**.

### Creating a line feature

1. In the *Name* field, enter a name for the feature.
2. To select the feature appearance color, tap **Color**.
3. To return to the *Select Feature* screen, tap **OK**.  
The new line feature appears in the *Line* list.
4. Select the new feature in the list and then tap **OK**.  
The new feature appears on the button you selected.
5. Tap **OK**.

## Creating an area feature

You can use area features to define areas of land as *Productive* or *Unproductive*. If the sprayer passes into an area that is defined as unproductive, the boom sections turns off. This can be useful for setting exclusion zones that you do not want to spray, for example, waterways.

1. In the *Name* field, enter the name of the feature.
2. If the area feature will be a section of land that can be included in area calculations, set the **Productive Area** button to *Yes*. If it is unproductive land, set the button to *No*.
3. To select the feature appearance color, tap **Color**.
4. If a signal pin is attached to the system, set the **Remote Output** button to *Enabled*. This enables you to trigger a pulse to an external device when you enter or exit this area.
5. From the *Trigger Warning* list, select one of the following settings.

Item	Description
No Warning	No warning appears
Entering Area	A warning appears while you are inside the area
Leaving Area	A warning appears while you are outside the area

**Note** – The *Remote Output* and *Trigger Warning* settings relate **only** to this type of area feature. They do not apply to any of your other area features. You must set the warning for each type of area feature individually.

6. Tap **OK**.  
The new area feature appears in the *Area* list.
7. Select the new feature from the list and then tap **OK**.  
The new feature appears on the button you selected.
8. Tap **OK**.

For more information on applying field features during navigation, see [Placing field features on screen, page 63](#).

## Activating field boundaries

The FmX integrated display includes the field boundary feature that enables you to map multiple-bounded areas within a field.

Field boundaries create a separate boundary file that can be used to calculate area and control automatic section switching at the edge of the field.

1. From the *Feature Mapping* screen, tap one of the *Selected Features* buttons. The *Select Feature* screen appears.
2. From the feature drop-down list, select *Area* and then tap **New**.

3. From the list of features, select *Boundary* and then tap **Edit**:

4. Set one or more of the following the attributes for the boundary features.

Attribute	Description
Name	a custom name that appears on the <i>Feature Mapping</i> tab.
Color	sets the color of the boundary outline and also the infill color, if selected.
Draw as	set to either Productive or Non-productive
Trigger Warning	sets a visual and audible warning when entering or leaving the boundary edge.
Remote Output	when enabled, this feature restricts remote output pulses from being triggered while outside the boundary.
Expand By (See the following image)	Sets how the boundary is actually recorded: <ul style="list-style-type: none"> <li>• Nothing: Maps the boundary exactly at the recorded position.</li> <li>• ½ Swath Width: Expands the recorded boundary location by ½ the swath width after the boundary is closed.</li> <li>• 1 Swath Width: Expands the recorded boundary location by 1 additional swath width after the boundary is closed.</li> </ul>

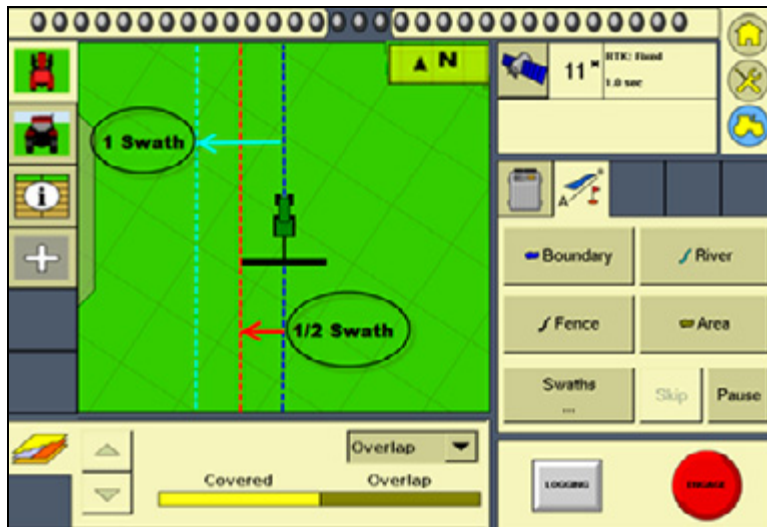

5. Tap **OK**. The *Select Feature* screen appears.
6. Tap **OK**. The *Feature Mapping* screen appears.
7. Tap **OK**. The *Display Setup* screen appears.
8. Tap **OK**.

### Recording a line feature with coverage logging

With the FmX integrated display, you can record a line feature simultaneously with coverage logging:

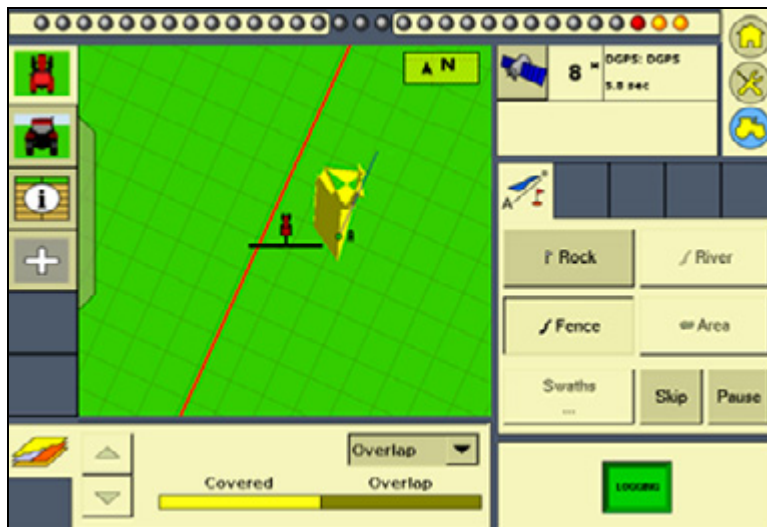

To activate line feature mapping:

1. From the *Display Setup* screen, select *Feature Mapping* and then tap **Setup**:
2. Tap one of the four feature buttons to create or select an active line feature and then tap **OK**.

- From the *Record Line With Coverage* drop-down list, select the required line feature and then tap **OK**. The *Display Setup* screen appears.
- Tap **OK**.

## Data Dictionary

The data dictionary editor enables you to predefine the entry options defined below and then select them from a pick-list during field and event definition.

### Data dictionary entry fields

Client	Implement	Target pests
Farm	Application method	Custom 1
Field	Wind speed	Custom 2
Event	Wind gust speed	Custom 3
Operator	Wind direction	Custom 4
Operator EPA #	Sky conditions	Material
Harvest year	Soil conditions	Stoppage reason
Farm location	Soil type	
Vehicle	Crop	

- From the *Display Setup* screen, select *Data Dictionary* and then tap **Setup**:

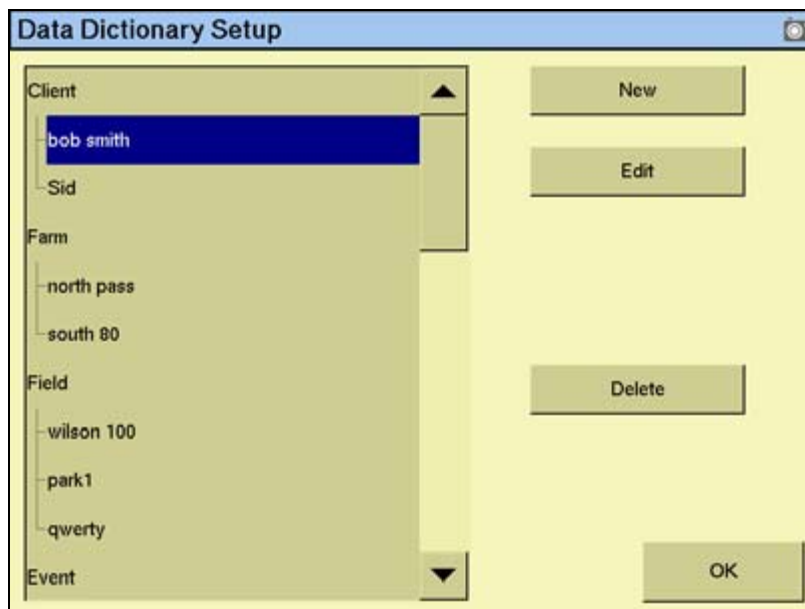

- From the data list, select the data field to define and then tap either **New** or **Edit**.
- Define the custom entry by manually entering or updating the name and then tap **OK**. The new or edited entry appears in the data list on the *Data Dictionary Setup* screen.

For more information on accessing and editing data dictionary entries, see [Data dictionaries](#), page 488.

## Lightbar

The display has two lightbar options:

- The virtual lightbar that appears at the top of the display's Run screen
- One, or more external lightbars. See [Chapter 21, The LB25 External Lightbar](#).

### Configuring the virtual lightbar

The FmX integrated display has default settings for the virtual lightbar that should suit most drivers. If the settings are not appropriate, configure the lightbar as follows:

1. From the *Display Setup* screen, select *Lightbar* and then tap **Setup**.

In the *Light Bars Configuration* screen the virtual lightbar from the FmX integrated display is shown ❶, along with any detected external lightbars ❷:

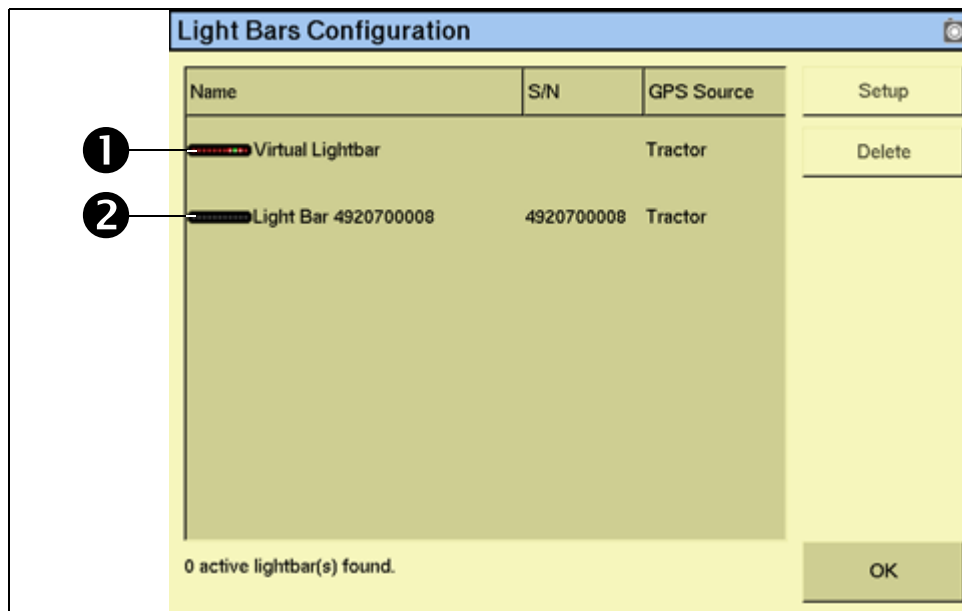

2. Select the *Virtual Lightbar* and then tap **Setup**.

Configure the following settings:

Setting	Affects...	Default setting	This setting determines...
Look ahead time	EZ-Guide® Plus lightbar	0 seconds	The distance ahead of the vehicle that the lightbar will use for LED guidance and offline distance.



Setting	Affects...	Default setting	This setting determines...
LED spacing	Virtual lightbar and EZ-Guide Plus lightbar	3 cm per LED/1 " per LED	The distance represented by each LED on the lightbar.
Display Mode	Virtual lightbar and EZ-Guide Plus lightbar	show error (chase mode)	How the LEDs respond to offline distances. When "Show error" is selected, the display shows the direction that you need to move in. When "Show correction" is selected, the display shows your current distance offline.

To set the look ahead time or the LED spacing:

1. Tap the appropriate number field.
2. In the dialog that appears, enter the required values.

To set the display mode:

1. From the *Display Mode* drop-down list, select the required option.
2. Enter the virtual lightbar settings and then tap **OK**. The *Lightbars Configuration* screen appears.
3. Tap **OK**.

The virtual lightbar is now configured.

## EZ-Remote joystick

For more information on installing and configuring the EZ-Remote joystick, see [Chapter 20, The EZ-Remote Joystick](#).

## Guidance

Selecting *Guidance* enables you to configure advanced guidance settings. If you are setting up the system for the first time, you should not need to adjust these settings.

### Enabling the Limit Field Selection filter

From the *Display Setup* screen, select *Guidance* and then tap **Setup**:

To review the settings, or if you have any guidance lines originally generated with an AgGPS 170 Field Computer or an FieldManager™ display, see [Advanced diagnostics](#), page 492.

### Sounds

1. From the *Display Setup* screen, select *Sounds* and then tap **Setup**:

There are two ways that the display can produce sounds:

- FmX: through an optional external speaker
  - Sonalert: through an optional Sonalert alarm
2. To enable a sound, select the required option from the drop-down list and then tap **OK**.

## CAN bus settings

**Note** – These settings are very advanced; use them only under the direct advice of Trimble Technical Support.

The FmX integrated display features advanced power management features to dim the backlight or turn off the display after a pre-set period of inactivity.

1. From the *Display Setup* screen, select *CAN Bus Settings* and then tap **Setup**:

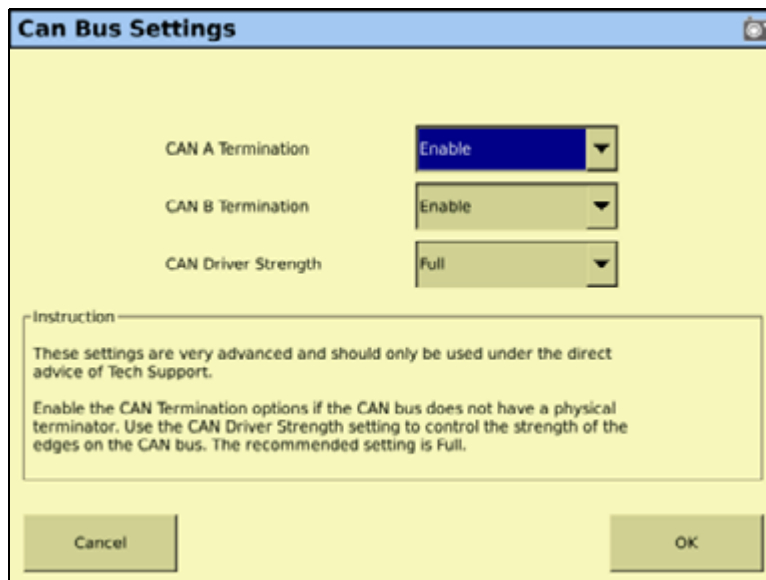

2. If either the A or B CAN buses do not have a physical terminator, enable the *CAN Termination* option for that bus.
3. To control the strength of the edges on the CAN bus, enable the *CAN Driver Strength* setting. It is recommended that you set the *CAN driver Strength* to *Full*.

## Power management

The FmX integrated display features advanced power management features to dim the backlight or turn off the display after a pre-set period of inactivity.

1. From the *Display Setup* screen, select *Power Management* and then tap **Setup**:

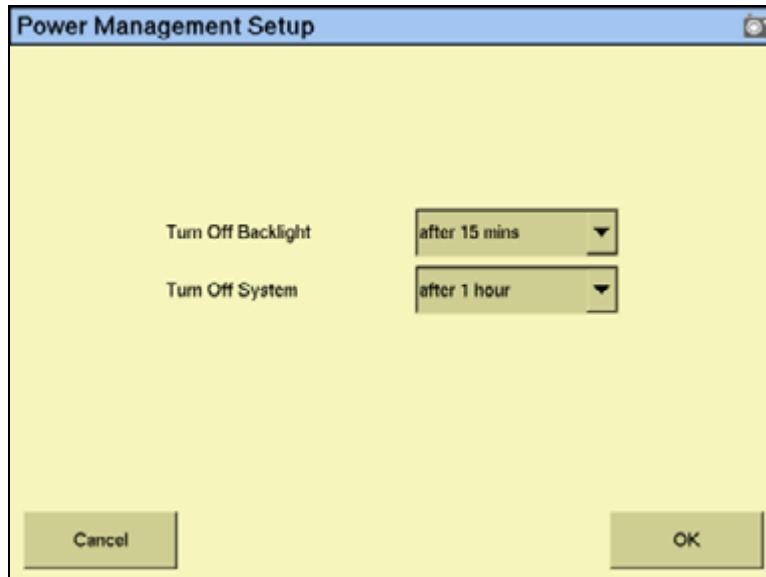

2. From the *Turn Off Backlight* drop-down list, select the required period of inactivity until the backlight dims.
3. From the *Turn Off System* drop-down list, select the required period of inactivity until the display shuts down.
4. Tap **OK**.

## Time zone

**Note** – Configuring the time zone can cause multiple warning messages to appear. Do not be concerned by this.

To synchronize the system time to the GPS signals:

1. From the *Display Setup* screen, select *Timezone* and then tap **Setup**:

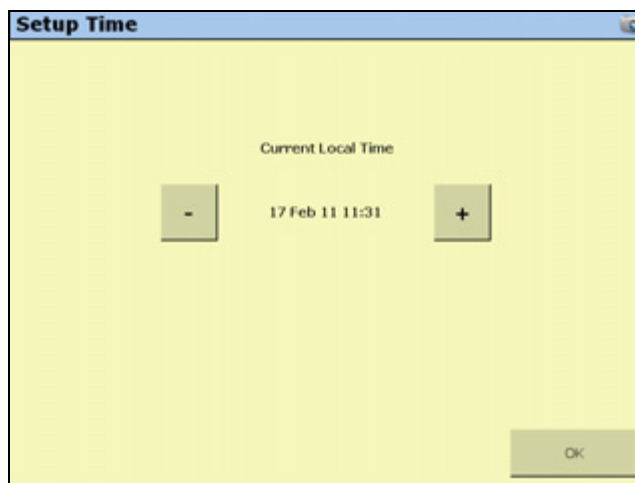

2. If the time is not correct, tap the - or + button to change the time by 1-hour increments.

## Signal input module for an OEM switch interface

The signal input module (SIM) can interface with existing equipment inputs to control on-screen buttons and features.

- A SIM must be connected to assign features to the buttons:

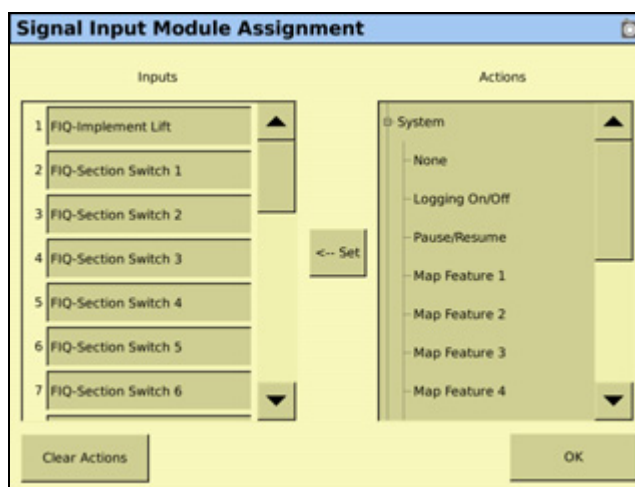

- To assign the buttons, highlight the action in the right column and then tap **< Set** to set the action to the specified input.



# Vehicle Guidance Options

## In this chapter:

- Manual guidance
- Autopilot automated steering system guidance
- Row Guidance
- EZ-Pilot assisted steering system guidance
- EZ-Steer assisted steering system guidance

You must configure the vehicle guidance settings before using the FmX integrated display. Vehicle guidance is controlled by either the manual guidance option, the Autopilot automated steering system option, the FieldLevel II plugins, or the EZ-Steer system plugin.

Several of these guidance options incorporate GPS receivers. For more information, see [Chapter 6, The GPS Receiver](#).

## Manual guidance

Manual guidance setup options enable you to configure the onscreen vehicle appearance and color:

1. From the Home screen, tap .
2. Make sure the Manual Guidance plugin is installed. For more information, see [Adding or removing a plugin, page 192](#).
3. Select the plugin and then tap **Setup**:

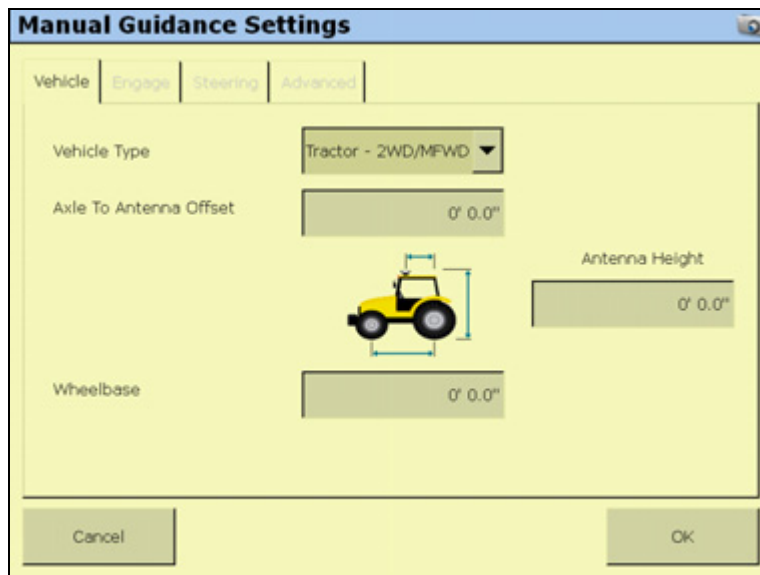

4. To change the vehicle's on-screen appearance, select a vehicle type from the drop-down list.
5. Use the virtual keypad to enter measurements into each of the following fields:
  - *Axle to Antenna Offset*: The horizontal distance between the axle and the antenna. If the antenna is in front of the axle, enter a "Forward" distance. If the antenna is behind the axle, enter a "Back" distance. Measure the distance accurately (within 3 inches). An incorrect offset may cause poor steering performance.
  - *Antenna Height*: Measure the antenna height vertically, from the ground to the base of the antenna.
  - *Wheelbase*: The horizontal distance between the center of the front wheel and the center of the back wheel.
6. Tap **OK**.

**Note** – Any changes that you make to the vehicle appearance remain even if you remove the Manual Guidance option and replace it with the Autopilot option.



## Configuring the GPS receiver

When you install the Manual Guidance option, the GPS Receiver option is also installed. For instructions on configuring the GPS receiver, see [Chapter 6, The GPS Receiver](#).

## Run screen for manual guidance

When you use the Manual Guidance option, the Run screen looks similar to when the Autopilot option is installed, except that:

- There is no *Autopilot* tab on the right
- There is no **Engage** button



You can still access the Mapping plugin to add field features or create guidance lines.

Since there is no Autopilot system to control steering, you must steer the vehicle manually while you watch the virtual lightbar for guidance.

## Autopilot automated steering system guidance

Prior to configuration, the Autopilot option must be installed on the FmX integrated display. For more information, see the *FmX integrated display Plug-ins Guide*.

There are two stages to configuring the Autopilot option:

- Configure the vehicle (select the current vehicle make and model).
- Calibrate the Autopilot automated steering system for your vehicle.

*Note* – The following configuration steps are usually done when the system is professionally installed.

### Configuring the Vehicle tab

1. From the Home screen, tap .
2. In the *Current Configurations* screen, tap **Configure**.
3. Select the Autopilot option and then tap **Setup**:

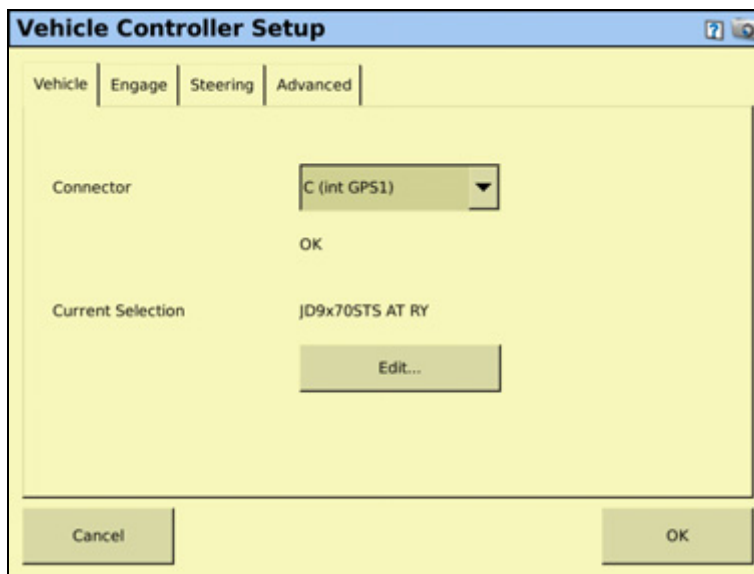

4. In the *Connector* list, select the port on the FmX integrated display that the Autopilot system controller is connected to.
5. The *Current Selection* displays the current vehicle (.vdb) profile that is loaded on the display. To change this setting, see [Selecting the vehicle, page 109](#).
6. In the *Vehicle Color* list, select the preferred color for the vehicle icon that appears on the Run screen.

## Configuring the Engage tab

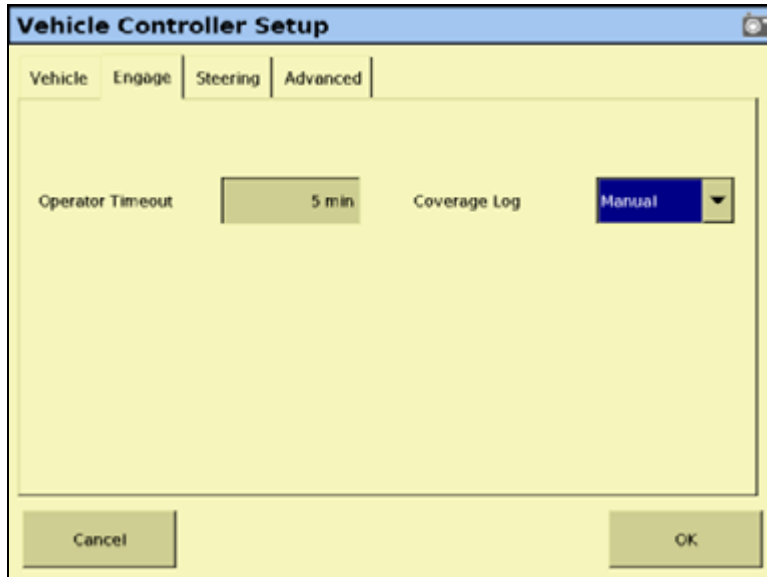

1. In the *Engage* tab, select Operator Timeout.
2. In the *Enter The EZ-Steer Operator Timeout* screen, enter a value and then tap **OK**.
3. In the *Coverage Log* list, select either Manual, or When Engaged.

## Configuring the Steering tab

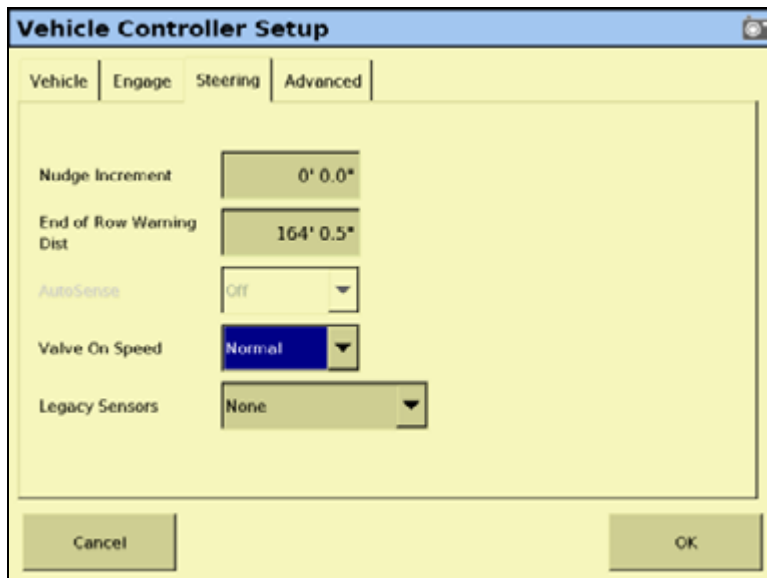

1. In the *Steering* tab, select Nudge Increment.
2. In the *Enter The Nudge Increment Distance* screen, enter the distance the Run screen **Nudge** buttons move the line back to the correct path, and then tap **OK**.

3. Select *End of Row Warning Dist.*
4. In the Enter *End of Row Warning Distance* screen, enter the distance for the end-of-row warning.

**Note** – *Longer vehicles that may take longer to turn require an earlier warning, which dictates a greater distance.*

5. In the *Autosense* list, select either On, or Off.

Most recent Autopilot systems use an AutoSense™ device that require this setting be set to On.

Older Autopilot system installations that use the electrical system to measure the vehicle status, select the appropriate connections under Step 7: *Legacy Sensors*.

6. In the *Valve On* speed list, select either Normal, Low, or Ultra Low.

Under normal operating speeds this should be set to Normal. For vehicles operating at very slow speeds, this should be set to Low or Ultra Low.

Display speed thresholds:

Setting	Speed threshold
Normal	> 0.4 m/s (1.3 ft/s)
Low	>0.1 m/s (0.3 ft/s)
Ultra Low	> 0.02 m/s (0.07 ft/s)

**Note** – *The Autopilot NavController II must have firmware version 5.10 or later to support the Low and Ultra Low settings.*

7. In the *Legacy Sensors* list, select either None, Wheel Speed Only, Gear Lever Only, or Wheel and Gear.

**Note** – *The Legacy Sensors list is only available when the Autosense setting is set to Off.*

## Configuring the Advanced tab

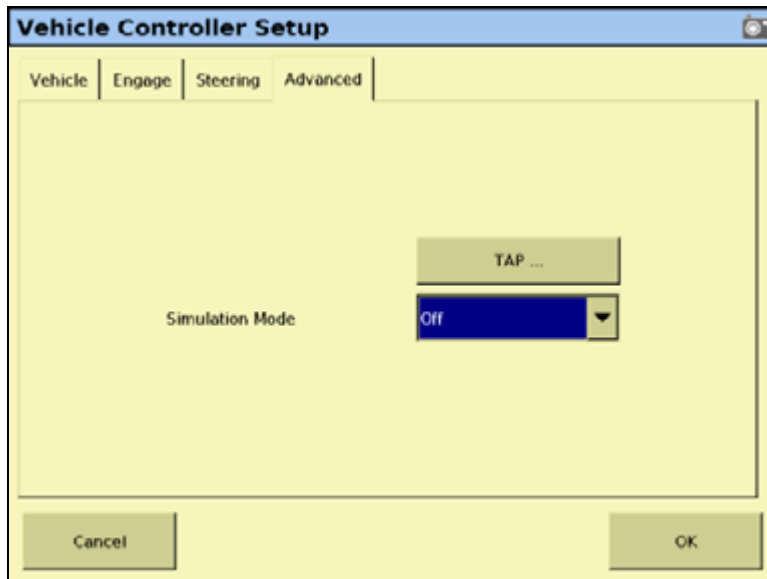

*Note* – For more information on how to utilize the features in the Advanced tab, contact your local reseller.

Tap **OK**. The Autopilot controller is now configured.

## Selecting the vehicle

1. In the *Vehicle* tab on the *Vehicle Controller Setup* screen, tap **Edit**:

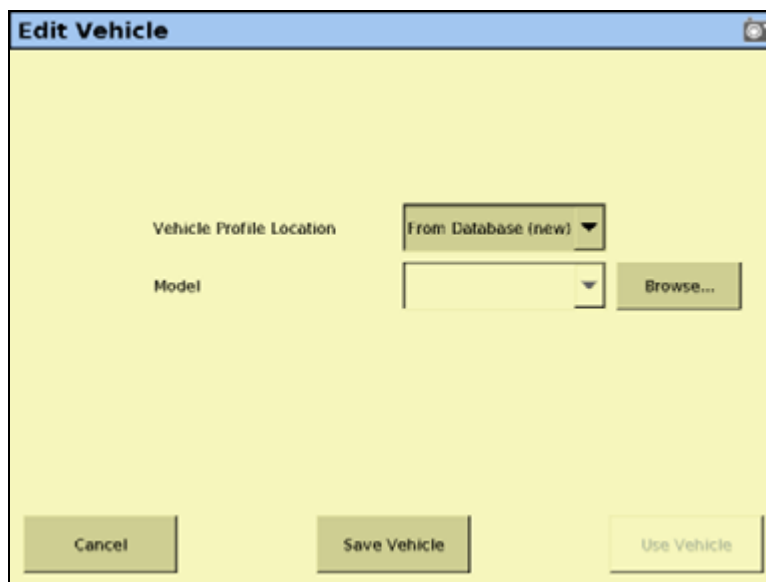

There are a number of pre-configured profiles for the various vehicle makes and models. You can load them from:

- Autopilot controller: The majority of vehicle profiles are stored on the Autopilot controller.
  - Vehicle profile database file: As additional profiles become available or are updated, they are added to a vehicle profile database. You can download the database and load profiles from it.
  - Saved file: You can install an individual vehicle profile that you have previously saved.
2. In the *Vehicle Profile Location* group, select the source for the make and model.

Tap this button...	See...	Then go to step...
From Controller (new)	Selecting a new vehicle make and model from the list on the Autopilot controller.	3
From Database (new)	Selecting a new vehicle make and model from a database of vehicles (.vdb) on the FmX integrated display. If you need to obtain a .vdb file, contact your local reseller.	4
From Saved File (existing)	Selecting a saved vehicle make and model from the display (.cfg) on the card.	5

### Selecting a new vehicle make and model from the list on the Autopilot controller

- a. From the drop-down list, select *From Controller (New)*.
- b. Tap the *Model* drop-down box and then select the make and model that you require from the list.

### Selecting a new vehicle make and model from a database

- a. From the drop-down list, select *From Database (new)* and then tap **Browse**.
- b. Select the .vdb file that you want to open and then tap **OK**.

### Selecting a saved vehicle make and model from the display

- a. From the drop-down list, select *From Saved File (existing)* and then tap **Browse**.
- b. Select the required file and then tap **OK**.
- c. Select *Change Vehicle* to save the new settings. The following message appears:

The specified vehicle model will now be selected on the Autopilot controller. This will cause the Autopilot controller to be reset. Do you want to continue?

*Note* – If you select a vehicle make and model but do not upload that configuration to the Autopilot controller, that make and model will not be loaded.

3. Tap **OK** to load the new configuration.

The following message appears:

The Autopilot controller will now be reinitialized in order to complete the vehicle selection.

4. Tap **OK**. The file is now loaded.

For more information on saving vehicle profiles on the FmX integrated display, see [Saving a vehicle profile, page 132](#).

## Autopilot calibration

Once you configure the vehicle make and model, calibrate the system for your individual vehicle.

The Autopilot system calibration process records additional details about your vehicle, which helps the system to steer the vehicle more accurately. For high accuracy systems, you must have all the settings correct.

The vehicle calibration screen tools are similar to those in the Autopilot Toolbox II software.

### Notes on calibration

- Before you perform vehicle calibration, select the vehicle make and model on the *Vehicle Setup* screen. See [Selecting the vehicle, page 109](#).
- No calibration is required if the system is installed on a Cat MT 700/800 series equipped with the ISO option.

## Common calibration items

You can calibrate several aspects of the vehicle. The calibrations that are available depend on which components are installed in the vehicle and system.

Four calibration options appear for all types of vehicle.

**Note** – You must perform the *Controller Orientation* and the *Roll Correction* calibrations.

Option	Description
Controller Orientation	Correctly associate the outputs of the Autopilot controller sensors with the direction of the vehicle.
Manual Override	Required for platforms that employ a pressure transducer for the manual override function. Change the default only if the operation of the manual override function is unacceptable.
Roll/Antenna Compensation	Compensates for antenna height and static roll caused by minor variations in the Autopilot controller and the GPS receiver mounting.
Line Acquisition	How aggressively the vehicle approaches the guidance line.

For articulated and front-wheel steered vehicles, three additional calibration options appear:

**Note** – The steering sensor and automated steering dead zone procedures are **required**. The steering sensor calibration must be performed first.

Option	Description
Steering Sensor (legacy potentiometer)	Converts the sensor output into commands for steering full left, full right, and any position in between.
Steering Sensor (AutoSense)	Orients autosense.
Automated Steering Deadzone	Required to learn the vehicle's steering dead zones.
Steering Gain (proportional steering gain)	Required only if system steering performance is unsatisfactory.

The **steering deadzone** is the amount of pressure that the system must apply to the hydraulics before the wheels begin to turn.

To configure this vehicle type...	See...
Hydraulically-steered tracked tractors	Page <a href="#">129</a>
Tracked tractor	Page <a href="#">129</a>

## Calibrating the Autopilot option

- From the Home screen, tap .
- In the *Current Configurations* screen, tap **Configure**.
- Select the Autopilot option and then tap **Calibrate**:

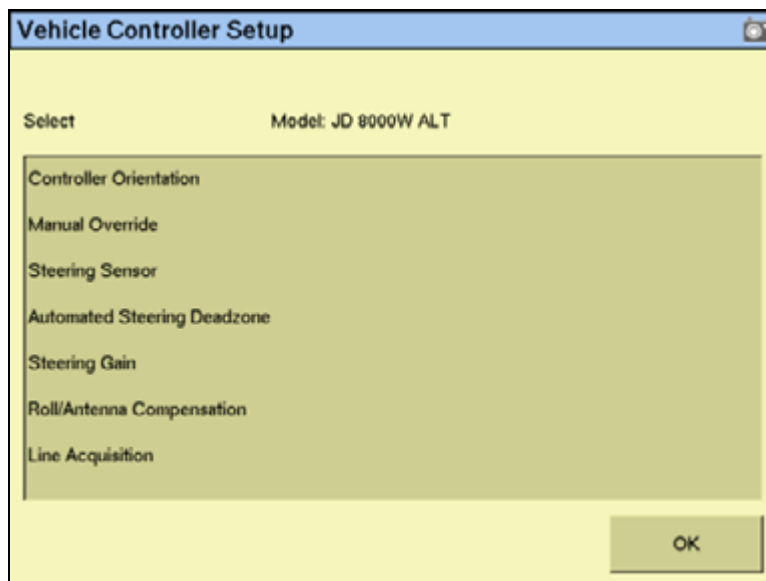

- Select an item to configure and then tap **OK**.



- Configure the selected item:

To configure...	See ...
Controller orientation	<a href="#">page 113</a>
Manual override	<a href="#">page 114</a>
Steering Sensor (legacy potentiometer)	<a href="#">page 116</a>
Steering Sensor (AutoSense)	<a href="#">page 116</a>
Automated steering deadzone	<a href="#">page 119</a>
Steering gain	<a href="#">page 121</a>
Roll/antenna correction	<a href="#">page 125</a>
Line acquisition	<a href="#">page 128</a>

## Configuring the controller orientation

- Select the *Controller Orientation* option from the list:

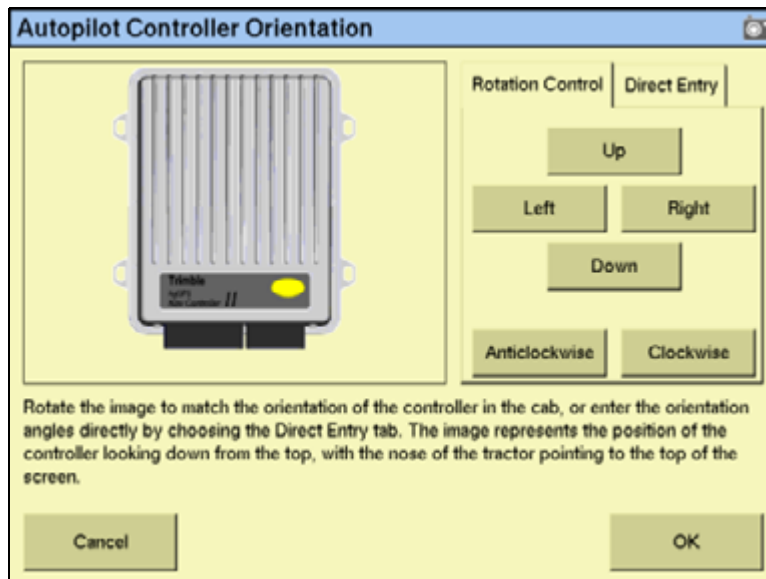

An image represents the current mounting orientation of the controller.

The image is shown as though:

- You are looking down on the vehicle from above.
- The top of the screen points to the nose of the vehicle.

- Use the buttons to select the orientation of the controller.

If the controller is set at a sloped angle, the vehicle profile will set the NavController orientation.

**Note** – Install the NavController as described in the vehicle install instructions. If custom angles are used, the on-screen image of the controller does not appear.

- Tap **OK** to accept the new orientation or tap **Cancel** to exit.

## Configuring the manual override sensitivity

Manual Override sensitivity calibration is valid only for platforms that employ a pressure transducer for the manual override function. The software automatically detects whether or not the vehicle configuration includes this type of sensor and provides this option if required.

One way to disengage the Autopilot system is to turn the steering wheel. This is called the **Manual Override**.

When you turn the steering wheel, there is a voltage spike that then tapers off. This spike and decline occurs at different levels for different models of tractor.

The manual override sensitivity is the level that the voltage must spike to before the override occurs and the system disengages. The voltage must also taper below that level before automated steering can be engaged again.

- If you set a high level of sensitivity, the system will disengage more quickly and you will have to wait longer before you can re-engage.
- If you set a low level of sensitivity, the system will take longer to disengage and you will be able to re-engage more quickly.



**WARNING –** Incorrect adjustment of the Manual Override Sensitivity calibration setting could cause this critical safety feature to fail, resulting in personal injury or damage to the vehicle. Any adjustment to this setting must be made only by an authorized dealer.

---

Trimble strongly recommends that you perform this calibration only if the default sensitivity is unacceptable under all conditions. ***Do not to choose a sensitivity setting that is either too sensitive or not sensitive enough.*** In either case, manual override may cease to function correctly. On some platforms, you could set the sensitivity so low that the manual override function will not detect any steering wheel motion. It is vital that you avoid this.

To configure and check the manual override:

1. Select the *Manual Override* option from the procedure list, see [page 111](#):

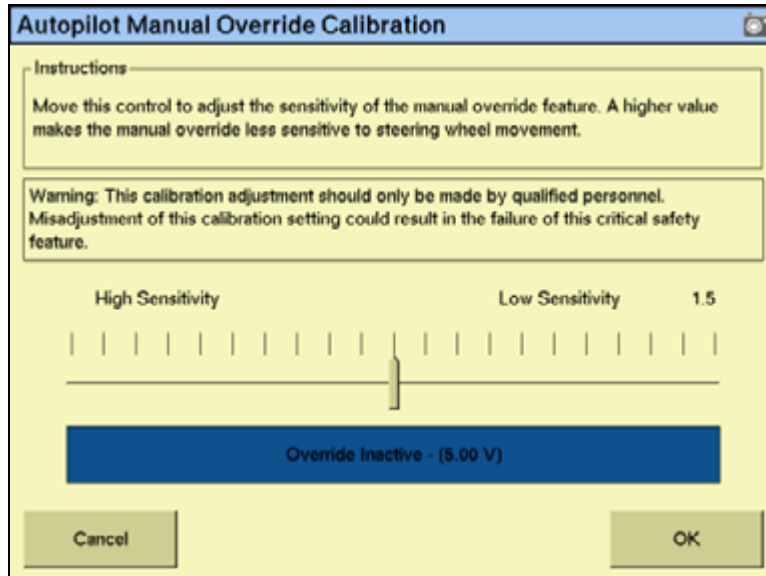

2. Test the current manual override setting:
  - a. Turn the steering wheel. The **Override Inactive** button changes color when the Override becomes active. With the system active, assess whether the manual override feature is at an acceptable level of sensitivity for:
    - Speed of steering wheel turn
    - Distance of steering wheel turn
  - b. To adjust the manual override sensitivity setting, select the slider bar. Move the slider bar as follows:

Slider bar direction	Result	Triggers manual override...
Left	Increased sensitivity	More easily
Right	Decreased sensitivity	Less easily

The value to the right of the slider shows the current setting. The total range is 0.5 to 2.5 (where 0.5 is the most sensitive setting and 2.5 is the least sensitive).

- c. To try the new setting, tap **OK**. The *Vehicle Calibration* screen appears.
- d. Select Manual Override again. The *Autopilot Manual Override Calibration* screen appears again.
- e. Repeat Steps b, c, and d to test each new setting.



**Tip** – You can also evaluate the performance of the manual override feature under conditions of loading and/or activities which may affect the pressure of the hydraulic system. For example, you can turn on the auxiliary hydraulics while you evaluate the manual override sensitivity.

- f. Tap **OK** to accept the new setting or tap **Cancel** to exit.

## Calibrating the AutoSense device

1. Select Autosense Calibration from the list on the *Vehicle Controller Setup* screen:
2. From the *Location* drop-down list, select the AutoSense position.
3. From the *Orientation* drop-down list, select the AutoSense orientation.
4. Tap **OK** to confirm selections.

## Calibrating the steering angle sensor

Perform steering sensor calibration to convert the voltage output of the steering sensor into an equivalent steering angle measurement.

**Note** – Complete this calibration **before** you attempt to calibrate the steering deadzone or roll correction procedures.

**Note** – Perform the steering sensor calibration only if a rotary potentiometer is installed on the vehicle. If an AutoSense device is selected as the steering angle sensor, the Steering Sensor screen does not appear.

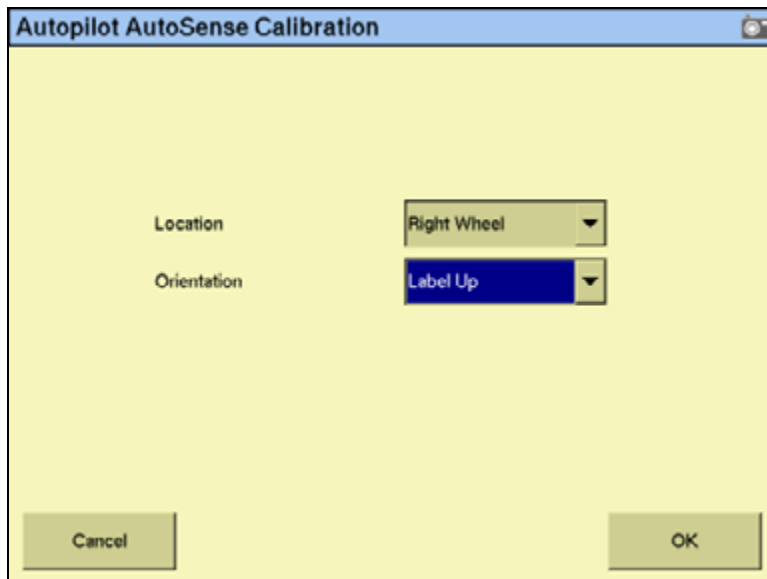

This calibration requires the vehicle to be in motion. Ensure that you:

- Perform this procedure on a hard, level surface that is free of obstructions.
- Maintain a tractor speed above 1.6 kph (1 mph).
- Watch the *Sensor Angle* field for a symmetrical angle reading at the steering extremes while you manually steer the wheels to full right and full left.
- Watch the *Sensor Angle* field to ensure that the angle reading is near zero while you manually steer the wheels straight ahead.

To run the steering sensor calibration:

1. Select the *Steering Angle* procedure from the calibration list. See [Autopilot calibration, page 111](#):

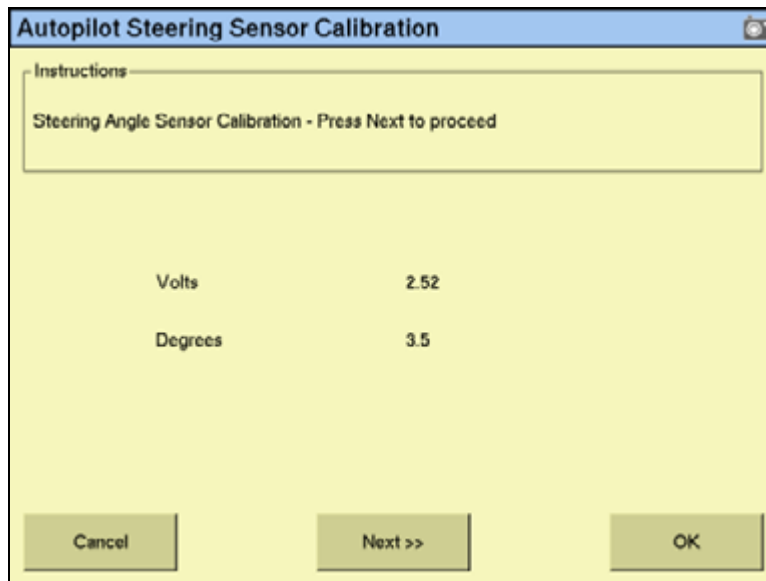

2. Move the tractor forward slowly.
3. Center the steering wheel and then tap **Next**.
4. Turn the steering wheel completely to the left and then tap **Next**. If the steering wheel is not turned completely to the left or if the steering sensor requires adjustment or replacement, an error message appears.

The value in the *Volts* field is updated as you turn the steering wheel:

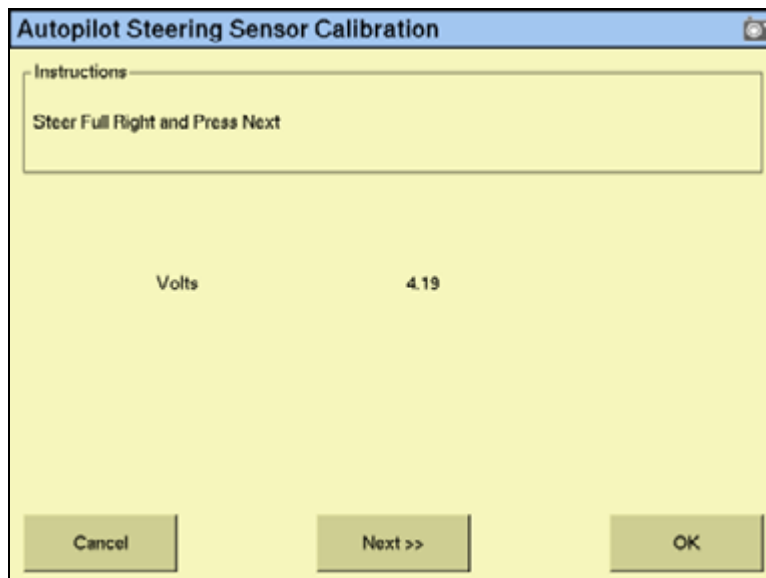

5. Turn the steering wheel completely to the right and then tap **Next**. If the steering wheel is not turned to the full right position or if the steering sensor requires adjustment or replacement, an error message appears.

The following screen appears:

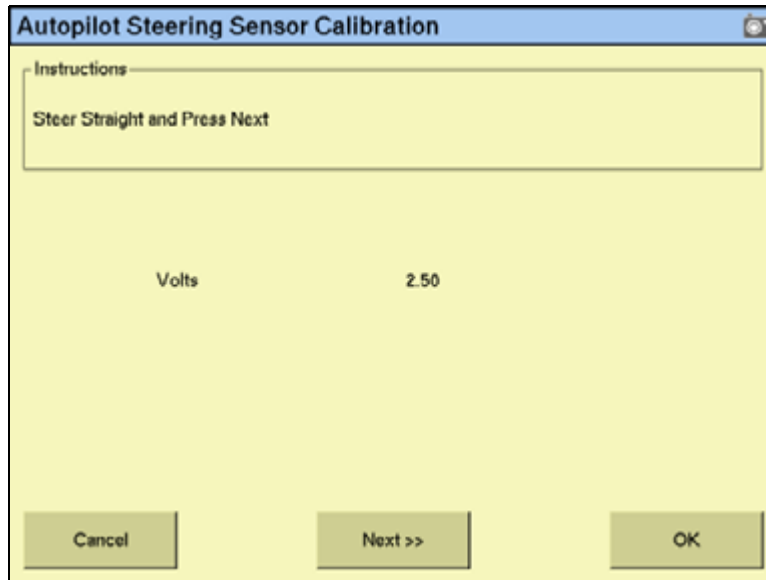

6. Center the steering wheel. While the wheel is at the center position, tap **Next**. The value in the *Volts* field is updated as you turn the steering wheel:

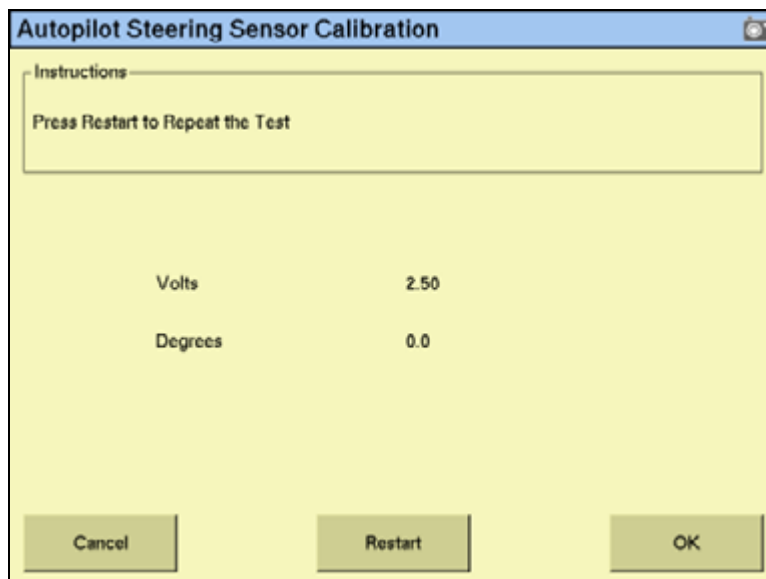

7. Tap **OK** to accept the calibration.

## Calibrating the automated steering deadzone

The Automated Deadzone calibration procedure runs a series of tests on the valve and steering hydraulics to determine the point at which steering movement occurs.



**WARNING** – During the Automated Deadzone calibration, the system moves the wheels that steer the vehicle. To avoid injury, be prepared for sudden vehicle movement.

In this test, the system independently opens and closes each side of the steering system while determining the point at which wheel movement occurs.

### Notes on calibrating the automated steering dead zone

- You must complete the Steering Angle procedure before you run this procedure.
- To ensure optimal system performance, the hydraulic fluid must be at normal operating temperature when you run this procedure. On some vehicles with large reservoirs, it may take several hours for the fluid to reach operating level, especially if the implement circuit is lightly loaded. Consult the vehicle documentation to determine if the hydraulic fluid temperature can be shown on a vehicle console.
- If you perform the calibration while the system is still cold, repeat both the Deadzone and the Proportional gain calibration procedures once the system is at operating temperature.

To configure the automated steering deadzone:

1. Place the vehicle in a large field that is free of hazards. To minimize the effect of the ground conditions, the field should have smooth soil that is loose but firm.
2. Select the Automated Steering Deadzone procedure from the calibration list. See [page 112](#).

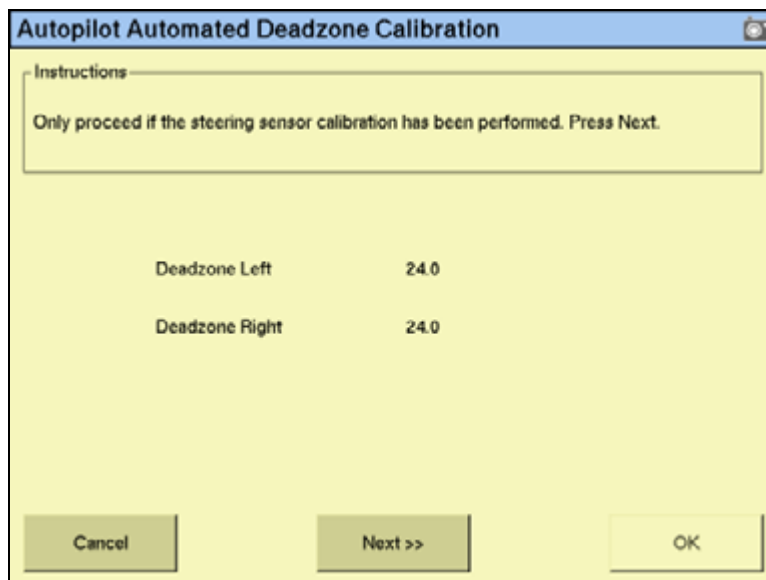

3. Tap **Next**.

4. Tap **Next** in the two screens that appear.
5. Follow all instructions. Tap the **Test Right** and **Test Left** buttons to perform the Deadzone calibration.

As ground conditions affect the results of this calibration, it is recommended that you perform the calibration at least three times, or until the average deadzone values change by less than about 0.5.

To minimize the total amount of space needed for the complete calibration, you can reposition the vehicle between the phases of the test. If the available flat, smooth space is extremely limited, re-align the vehicle after each segment of the calibration.

To reposition the vehicle:

1. Wait until the software prompts you that the next phase is ready to begin.
2. Look at the screen to determine whether the next phase will require a left or right turn.
3. Reposition the vehicle so that the turn will use the space that you have available.
4. Tap the button to begin the next phase.



**CAUTION** – Obstacles in the field can cause collisions, which may injure you and damage the vehicle. If an obstacle in the field makes it unsafe to continue a particular phase of the Automated Deadzone calibration, stop the vehicle to abort the phase and turn the steering wheel to disengage the system. Reposition the vehicle and continue from the current test phase.

### Automated Deadzone error messages

If a calibration cycle is unable to complete successfully, one of the following error messages appears:

Message	Meaning
Error - Manual Override Detected	Manual override was detected before the calibration cycle could be completed. Retry.
Error - Vehicle Moving Too Slow	The vehicle was moving too slowly for the calibration cycle to successfully finish. Make sure the vehicle is moving at least 0.8 kph (0.5 mph) during each calibration cycle.
Error - Steering Close To End Stops	Before the calibration cycle could be completed, the measured steering angle approached the end stops. Retry, and if the problem persists, instead of centering the steering at the start of each cycle, try turning the steering in the opposite direction to that which is being tested so that the calibration procedure has a greater range to test over.
Error - Valve Connectors Could Be Swapped	The calibration test sensed the steering turning in the opposite direction to what was expected. Retry, and if the problem persists either the valve connectors have been accidentally swapped or the steering sensor calibration was performed incorrectly.
Error - No GPS	A GPS receiver must be connected and outputting positions before the software can run the calibration procedure.
Error - No Steering Response Detected	During the calibration cycle, insufficient movement was sensed for the calibration to complete. If the problem persists, the hydraulic installation could be faulty.



Message	Meaning
Error - Unable To Determine DZ: Try Again	A problem occurred when trying to compute dead zone. Retry, and if the problem persists, contact Technical Support.
Error - Software Problem Detected	The software was unable to complete the calibration due to insufficient movement of the vehicle. If the problem persists, contact Technical Support.

## Calibrating the proportional steering gain

**Note** – Complete the steering sensor calibration **before** you perform the proportional gain calibration. Perform the proportional steering gain calibration **only** when the Autopilot system performance is less than satisfactory.

The proportional steering gain (PGain) setting enables you to reach a compromise between rapid steering response and stability. Modifications to the PGain setting affect two steering characteristics:

- *Slew Time*: The amount of time that the front wheels take to move from the far left to the far right position and vice versa.
- *Overshoot*: The percentage by which the front wheels exceed the commanded angle before they settle on the correct value.

To correct slight variations caused by valve current response, friction, and hydraulic fluid viscosity, alter these settings.

High PGain values...	Low PGain values...
Decrease the slew time and increase the overshoot. This provides rapid responses, but can cause the steering to exhibit signs of instability (for example, a tendency to excessively overshoot).	Increase the slew time and decrease the overshoot. This improves the stability but can introduce significant delays in the steering response and can cause the vehicle to oscillate from side to side.

### Notes on performing the proportional steering gain calibration

- Perform the Automatic Deadzone calibration immediately before you run the PGain calibration, even if the Automatic Deadzone calibration has been performed in the past.
- Perform this calibration on a hard, level surface that is free of obstructions.
- Maintain a vehicle speed above 1.6 kph (1 mph) while you perform the calibration.

Increase the proportional gain up to the point just before any one of the following occurs:

- Slew times no longer decrease (a low value is required)
- Overshoot exceeds 5 – 8% (depending on the vehicle)
- Wheels noticeably shake near end stops

To calibrate the proportional steering gain:

1. Select the Valve P-gain procedure from the calibration list. See [Autopilot calibration, page 111](#). The first *Autopilot Steering Gain Calibration* screen appears:

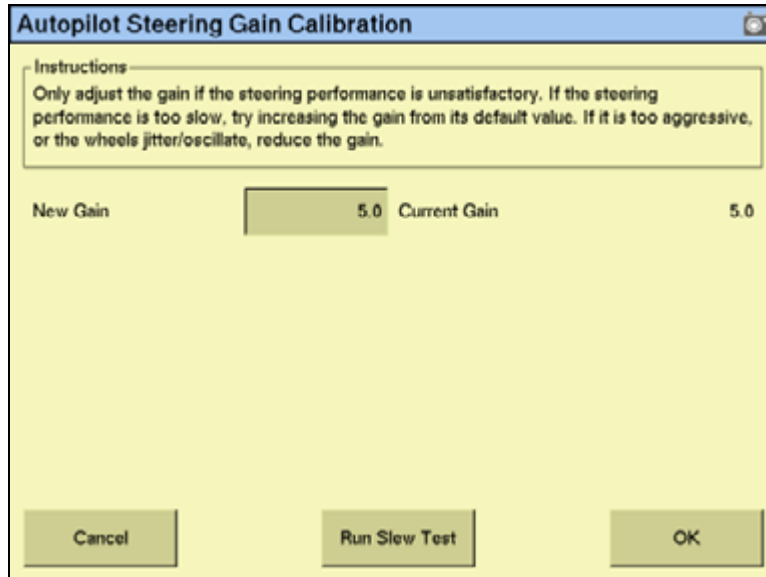

2. Tap **Run Slew Test**. A warning message appears.
3. Tap **Next**.



**CAUTION** – The wheels can move abruptly during the Proportional Steering Gain procedure while the Autopilot system tests the hydraulic response to the steering commands. These sudden movements can cause collisions with nearby obstacles or cause injury to occupants of the vehicle. Be prepared for sudden wheel movements.

4. Tap **Next** in the next two screens that appear.
5. Test various gain settings while you monitor the vehicle performance and the values in the *Slew Time* and *Overshoot* fields for the Turn Left phase.
  - a. Adjust the *New Gain* field (if required).
  - b. Turn the front wheels completely to the right to begin the test. (The test is for the stop-to-stop position.)

- c. Tap **Turn Left**. Both turn buttons are unavailable while the wheels slew:

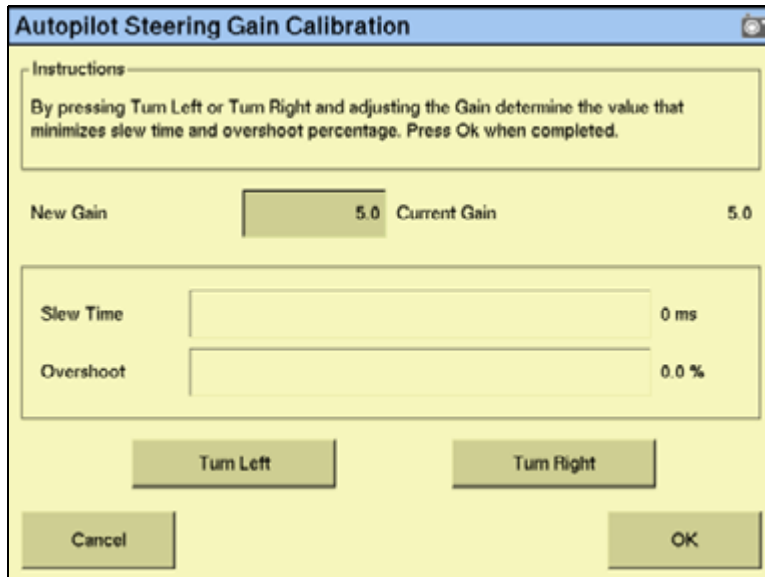

***Note** – The optimum gain setting has short slew time (short millisecond reading) and low overshoot percentage (less than 5–8%).*

6. Repeat Step 5 with **Turn Right**. Both turn buttons are unavailable while the wheels slew.
7. When you locate the best gain value, do one of the following:
  - Tap **OK** to save the value in the Autopilot controller memory.
  - Tap **Cancel** to restart the calibration procedure.

## Configuring the antenna position and roll offset correction

**Note** – Antenna offsets are provided when the antenna cannot be placed directly over the working point of the implement. It is recommended that these offsets are minimized whenever possible.

1. Select *Roll/Antenna Correction* from the calibration list, see [page 111](#):

2. Before changing these settings, complete the following procedures.

### Notes on configuring the antenna position

- Before configuring the antenna compensation, make sure that:
  - The Autopilot system is completely set up
  - The Autopilot software is properly configured
  - The correct GPS corrections are enabled
  - You read this section carefully
- If multiple GPS technologies will be used ( for example, RTK and SBAS), use the technology with the highest accuracy when you perform the Roll Correction calibration.

### 1. Setting the antenna height above the ground

1. Place the tractor on a flat, level surface.
2. Measure the distance from the ground to the base of the GPS receiver (or antenna).
3. Enter this value in the *Antenna Height Above Ground* field.

## 2. Setting the antenna distance from the fixed axle

1. Place the tractor on a flat, level surface.
2. Measure the distance from the fixed axle to the center of the GPS receiver (or antenna).
3. Enter this value into the *Antenna Distance from Fixed Axle* field. Enter a negative value if the GPS receiver antenna is to the rear of the fixed axle. The nose of the vehicle is considered the forward direction.

## 3. Configuring the roll offset correction

Use one of the following methods to calculate the roll offset and then enter the roll offset correction to compensate for it:

- Tire track offset method
- Flag offset method

Choose the method which best matches the conditions.

### Calculating the roll offset: Tire track offset method



**Tip** – Use a highly repeatable GPS correction mode for roll correction. For best results, use a RTK mode or OmniSTAR HP signal that has been converged for at least twenty minutes. If you do a roll calibration with less accurate GPS correction modes, repeat the measurements **at least four times** to ensure a more consistent result.

1. Remove any implement from the vehicle.
2. Drive the tractor to a relatively flat field where tire impressions are visible and where you can complete passes of at least 400 m (1320 ft) in length.
3. Reset the roll offset value to 0 (zero).
4. Create an AB Line.
5. Create a clean set of tire tracks in the field. To do this, start a new pass away from the area where the AB Line was created. When the system is stable, engage automatic steering mode and allow the Autopilot system to complete the pass.
6. At the end of the pass, turn the tractor around to return along the same pass from the opposite direction.
7. Engage automated steering mode and allow the system to complete the pass.
8. In the middle of the return pass, stop the tractor and confirm that the current position is directly on the AB Line. This ensures there is no cross track error.
9. Park the tractor and exit the cab. Evaluate the tire track pattern between the first and return paths.
10. Measure the difference between the track passes and record the distance. Also note whether the return pass is to the left or the right of the original pass. Record the results in [Table 11 on page 127](#).

**Note** – *The offset should be consistently to the left or right.*

11. Repeat Step 5 through Step 10 two more times, for a total of three test runs. Use [Table 11](#) on [page 127](#) to record the offset distance and the left or right direction of offset for each test run.

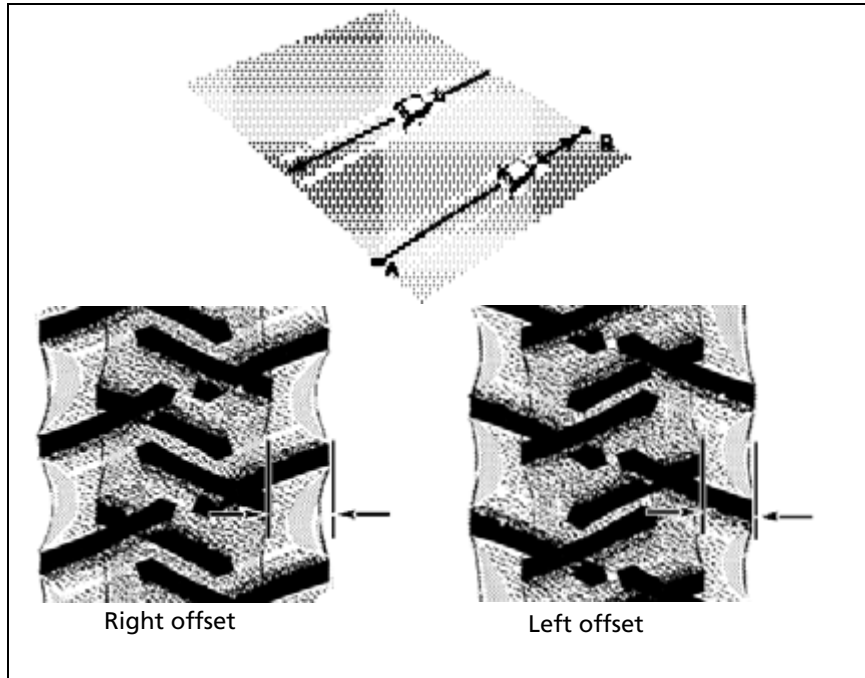

### Calculating the roll offset: Flag offset method

1. Remove any implement from the vehicle. The vehicle draw-bar must be centered.
2. Drive the vehicle to a relatively flat area where you can complete passes that are at least 400 m (1320 ft) in length.
3. Reset the *Roll Offset* value to 0 (zero) on the *Roll Correction* screen. See [3. Configuring the roll offset correction, page 125](#).
4. Create an AB Line.
5. Start a new pass. Engage automatic steering mode when the system is stable. Stop the tractor midway through the pass. Confirm that there is no cross track error: the current vehicle position should be directly on the AB Line.

- Park the vehicle and exit the cab. Use the hitch pin hole in the drawbar as a guide to insert a flag in the ground to mark the vehicle center-line for this pass.

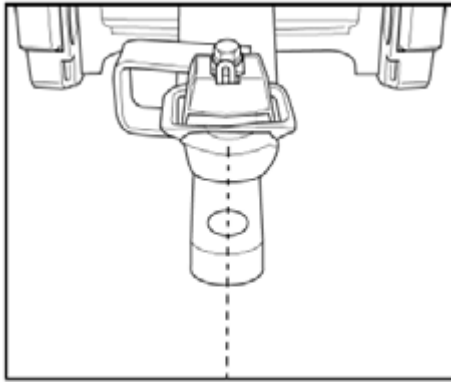

- Complete the pass. Turn the vehicle around to return along the same pass from the opposite direction.
- Engage automatic steering mode. Stop the vehicle midway down the pass with the drawbar pin location very close to the marker flag. Confirm that there is no cross track error: the current vehicle position should be directly on the AB Line.
- Park the vehicle and exit the cab. Use the hitch pin hole in the drawbar as a guide to insert a second flag in the ground to mark the tractor centerline for this pass. Note whether the second pass is to the left or the right of the first pass.
- Measure the difference between the flags for the two passes and record the distance. Also record whether the return pass is to the left or the right of the original pass. Record the results in the table on [page 127](#).

**Note** – The offset should be consistently to the left or right. The following figure shows an example of a right offset—measure the distance between the flags.

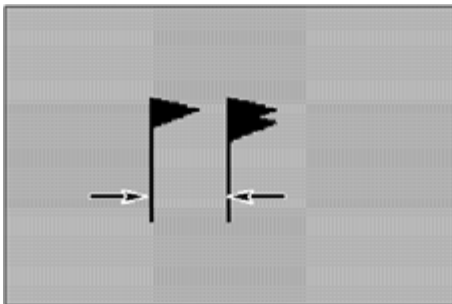

- Repeat Steps 5 to 10 two more times for a total of three test runs. Use the following table to record the offset distance and the left or right direction of offset for each test run:

Test run	Offset distance	Offset direction
1		
2		
3		

Test run	Offset distance	Offset direction
	Total =	
	Total/3 = (Average offset value)	

12. Average the results of the three runs. (Total the offset distances from the three passes and divide by three).

### Entering the roll offset

1. Enter the average offset value in the *Roll Offset* field. See [Configuring the antenna position and roll offset correction](#), page 124.
2. Select one of the offline direction options, depending on whether the roll offset distance is to the left or right.

### Calibrating the line acquisition aggressiveness

1. Select *Line Acquisition* from the calibration list. See [page 111](#).

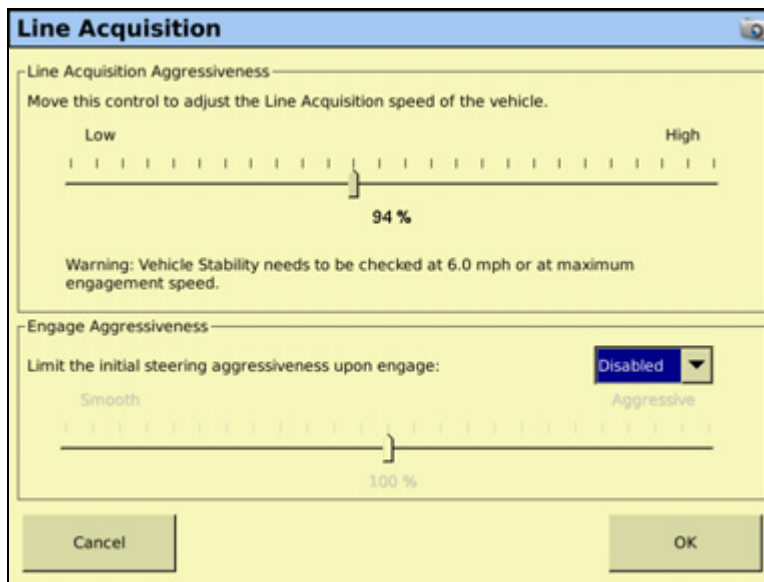

2. Adjust the line acquisition aggressiveness slider. The slider controls how aggressively the vehicle approaches the guidance line, using a scale from 50% to 150%. The optimal value for each profile is not necessarily 100%: it varies for different vehicle profiles.

**Note** – When you adjust the slider, check the vehicle stability at the speed shown or at the maximum engage speed.



## Calibrating a tracked tractor

If you selected a tracked tractor as the make and model, the *Track Spacing* option appears on the calibration list. (This option is not shown in the *Vehicle Controller Setup* screen shown on page 112).

### Track Spacing value

Use this option to configure the width of the tracks on the vehicle. The width of the vehicle tracks is the distance from halfway across the width of the left track to halfway across the width of the right track:

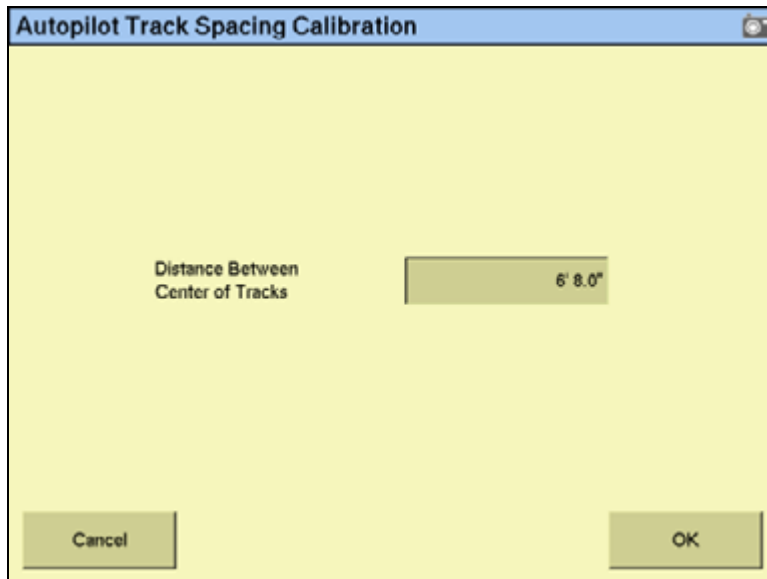

### Calibrating a hydraulically-steered tracked tractor

If you selected a hydraulically-steered tracked tractor as the make and model, *Engine Speed* appears on the calibration list.

### Notes on hydraulically-steered tracked vehicles

- This group of vehicles includes the CAT/AGCO Challenger Tracked family.
- No calibration is required if the system is installed on a CAT MT 700/800 series equipped with the ISO option. This also includes John Deere tracked vehicles.

### Autopilot RPM Sensor Calibration screen

The *Autopilot RPM Sensor Calibration* screen enables you to verify that the RPM sensor output is correct:

If the *Engine RPM* value is not close to the actual engine RPM, follow the onscreen instructions to adjust the sensor output.

### Autopilot Hydraulic Pump Response Time Calibration screen

The *Autopilot Hydraulic Pump Response Time Calibration* screen verifies and optimizes the response of the hydraulic steering pumps. Follow the onscreen instructions to perform this procedure:

## Autopilot Steering Pump Knees Calibration screen

This calibration procedure determines the compensation required for dead-band in the steering pumps:

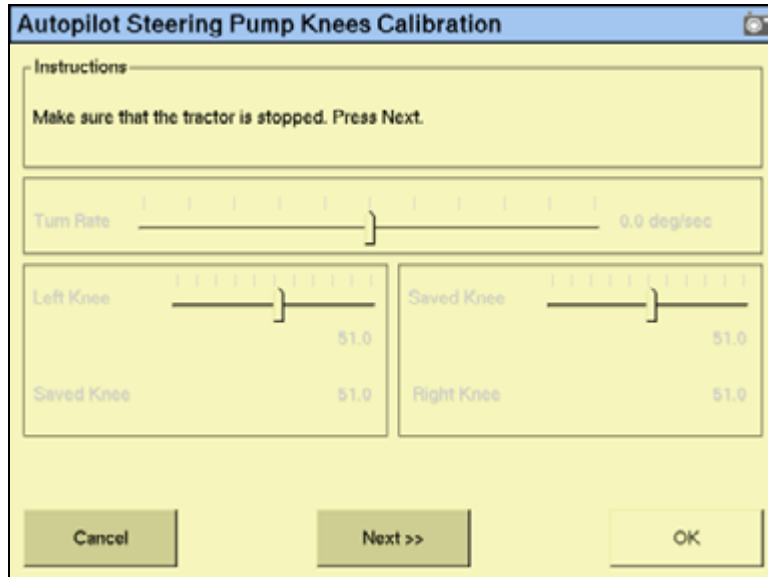

**CAUTION** – The vehicle needs to move during the Hydraulic Tracked Pump Knees calibration procedure. To avoid injury, be prepared for vehicle movement.

The instructions for this calibration test span several pages on screen. Follow the instructions on each page.

## Tracked vehicle steering wheel calibration

1. Turn off the engine, but keep the ignition key in the run position.
2. From the Autopilot Calibration screen, select *Steering Interface Calibration*.

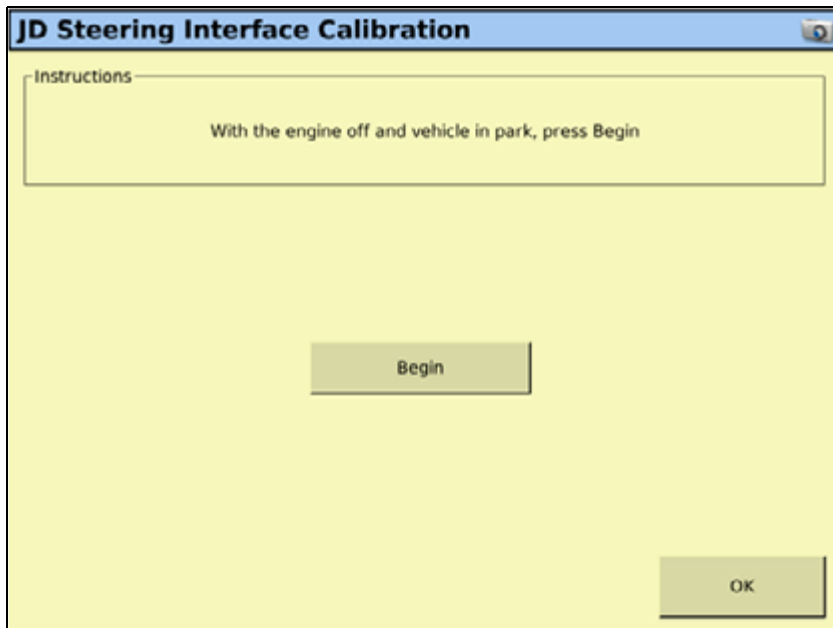

3. ***Keeping to the suggested time interval***, follow the on screen instructions to turn the steering wheel right and left, full lock.
4. Follow the on screen instructions until **Calibration Complete** appears on screen.

## Saving a vehicle profile

**Note** – From firmware version 3.0 on the FmX integrated display, the Vehicle Profile Location defaults to “From Database”.

Once you configure and calibrate the Autopilot system for your vehicle, you can save that information for later use. This can be useful if you want to adjust the settings or if you move the display from one vehicle to another.

1. From the Home screen, tap .
2. In the *Current Configurations* screen, tap **Configure**.

3. Select the Autopilot option and then tap **Setup**:

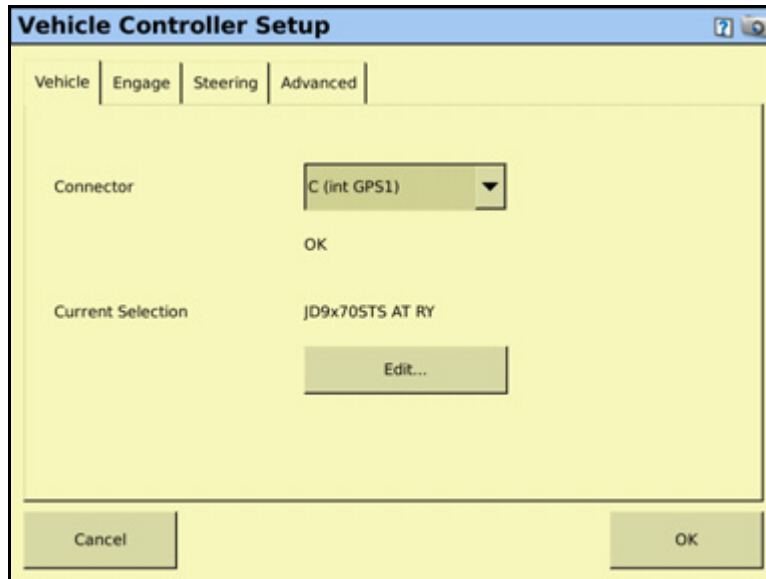

4. In the *Vehicle Controller Settings* group, tap **Edit**:

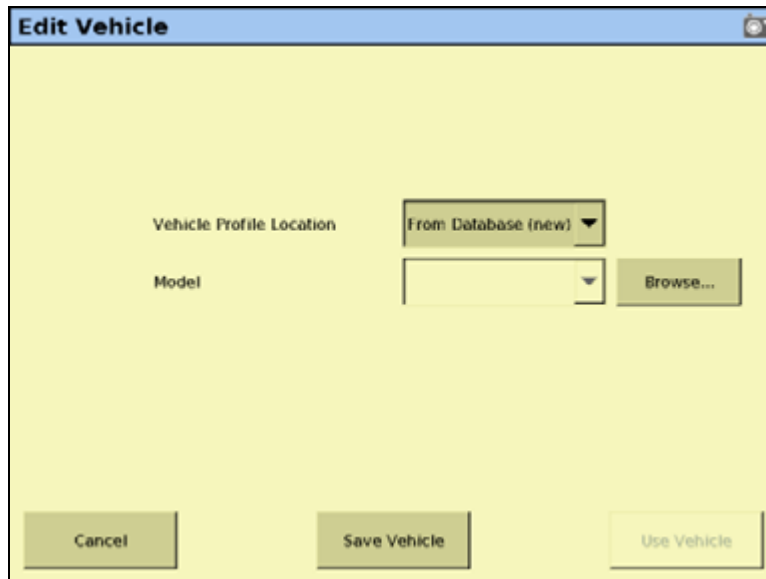

5. Tap **Save Vehicle**.
  6. In the *Save Vehicle Configuration* screen, select the *Filename* field.
  7. In the *Enter Save Filename* screen, enter a name for the current vehicle profile and tap **OK**.
  8. In the *Edit Vehicle* screen, tap **OK**.
- Your current vehicle profile is saved.

## Configuring the GPS receiver

When you install the Autopilot option, the GPS Receiver option is also installed. For instructions on configuring the GPS receiver, see [The GPS Receiver, page 171](#).

## Adjusting the Aggressiveness setting

Aggressiveness is the measure of how strongly the system makes steering changes.

- A higher *Aggressiveness* setting brings the vehicle back online faster, but may cause tight oscillations about the line.
  - A lower *Aggressiveness* setting is slower to bring the vehicle back online, but can avoid overshoot.
1. From the Run screen, select the *Autopilot* tab:

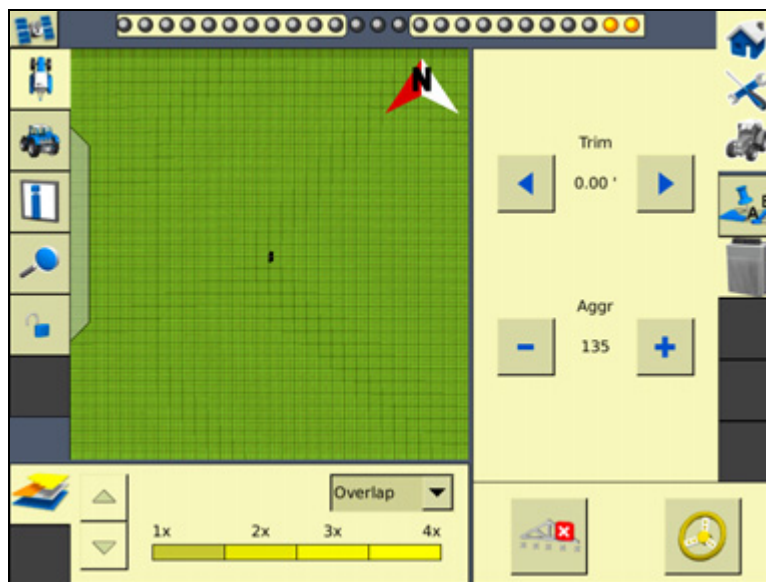

2. Use the - or + button to adjust the setting.

*Note* – The default *Aggressiveness* setting is 100%.

For a description of the Autopilot **Engage** button, see [Engage button, page 47](#).

## Display-only mode

The FmX integrated display can be used as a standalone display for a NavController II that is connected to an external GPS receiver.

When used in this mode, the FmX integrated display's two internal GNSS receivers are not used by the NavController II, but they are still available for other applications.

In this mode, you must use the special adaptor cable (P/N 76442) with the standard FmX/FM-1000 to NavController II cable (P/N 75741 or P/N 65522) to connect the display to the P4 display port on the NavController II.

*Note* – You must install the Autopilot option to use the display-only functionality of the FmX integrated display.

### Connecting the FmX integrated display for display-only mode

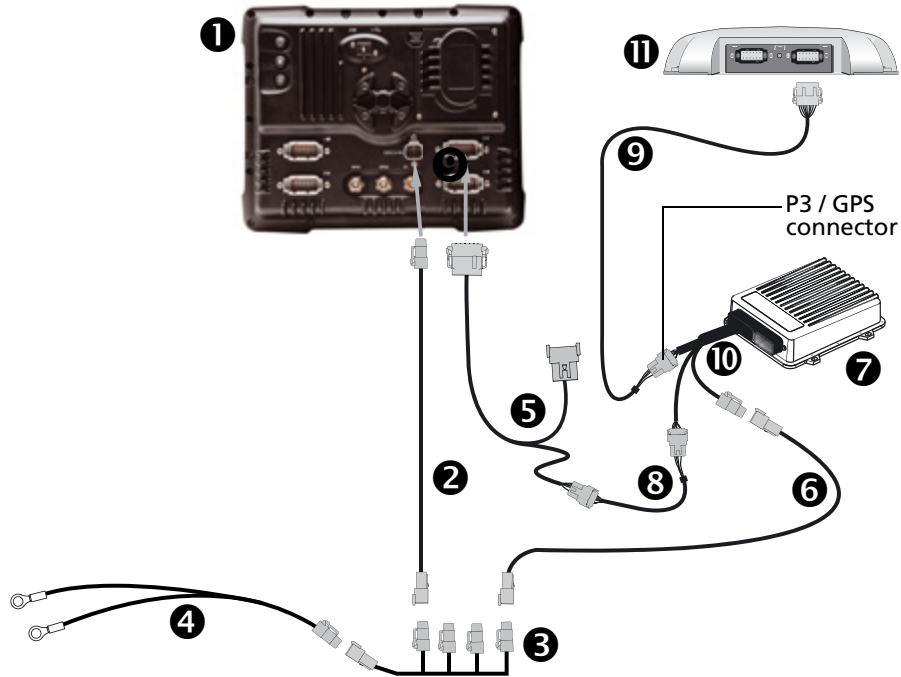

**CAUTION** – Connecting the Port Replicator on the FmX to NavController II cable 5 to the P4 or P12 connector of the NavController II harness 10 will result in damage to the FmX integrated display, and will void the warranty.

Item	Description	Trimble part number
1	FmX integrated display	93100-01
2	FmX power cable	66694
3	FmX power cable with relay and switch (power bus)	67259
4	Basic power cable	67258
5	FmX to NavController II cable with port replicator	75741
6	2 pin DTM to 2 pin DT power adaptor	67095
7	NavController II	55563-00
8	Cable assembly, 8-pin to 12-pin adaptor	76442
9	Cable, AgGPS 252/252 to NavController II	54608

Item	Description	Trimble part number
⑩	Main NavController II cable	54601
⑪	AgGPS 252/262 receiver	55500-32

To configure the display-only mode, do the following:

1. In the *Current Configurations* screen, tap **Configure**.
2. Select the Autopilot option and then tap **Setup**:

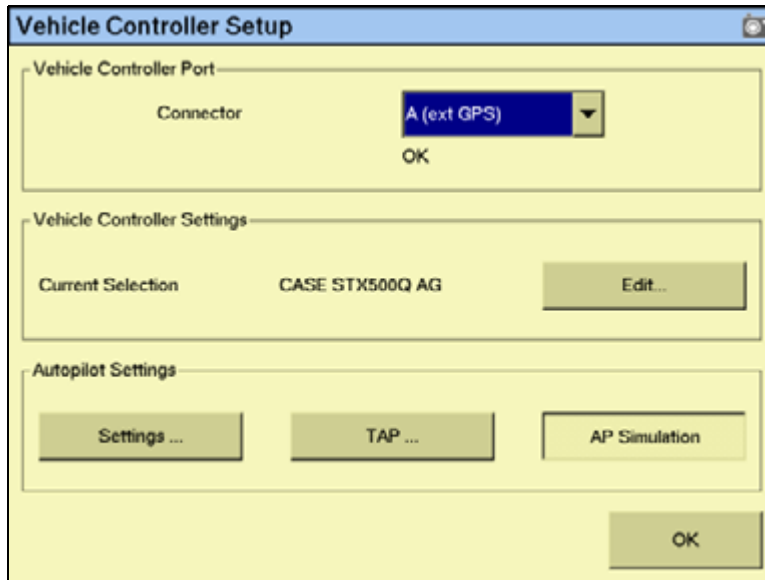

3. From the *Connector* drop-down list, select either *A (ext GPS)* or *B (ext GPS)* and then tap **OK**. The *Configuration* screen appears.
4. Select the Autopilot option's GPS receiver and then tap **Setup**:

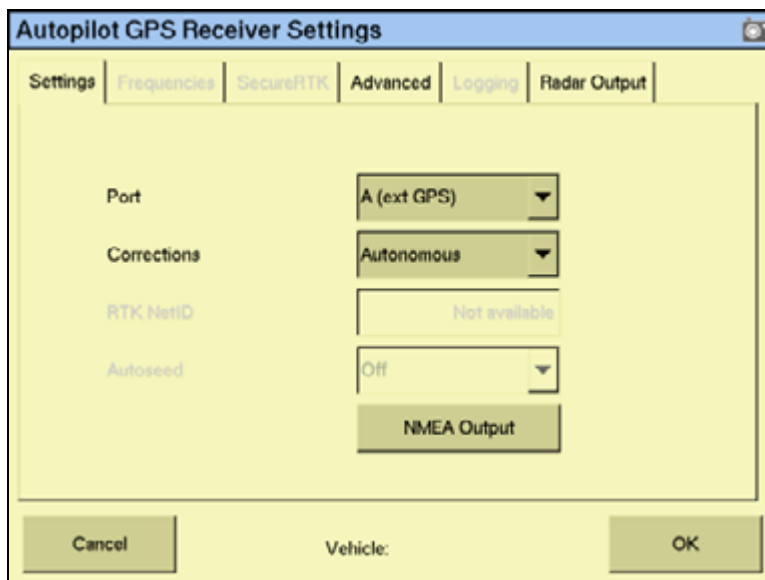



5. From the *Corrections* drop-down list, select the required correction option.
6. Tap **OK**.

## Row Guidance

When the RG-100 row guidance plugin has been activated on the FmX integrated display, the Autopilot automated steering system will follow curved or hillside corn rows that do not exactly match the guidance line. The Autopilot system is required.

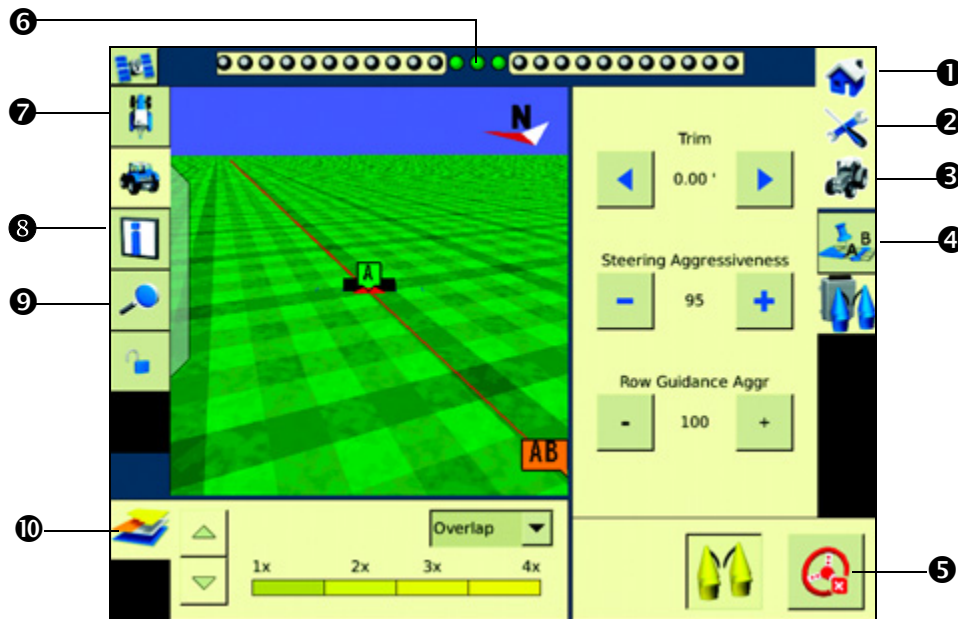

Item	Description
1	Home Tap to close a field and return to the start window.
2	Setup and configuration Tap to change some setup and display options when the field is open.
3	Run icon Tap to take a picture of the current screen.
4	Active plug-in tab Show status and control functions for the applications connected to the FmX integrated display. Tap the Tab icon to change the tab.
5	Engage panel Contains the engage controls for plug-ins such as the Autopilot automated steering system, TrueTracker implement steering, and the FieldLevel II automated levelling system. You can also control for coverage logging.
6	Offline guidance display When the vehicle is online, the center indicators are green. When the vehicle moves offline, the indicators change to red and move to either side, depending on the direction to the line.
7	Vehicle view Tap to toggle between overhead and trailing views.
8	Information dialog Tap to display a larger amount of permanent text for operations relating to the display while viewing the Run dialog in the upper right-hand corner.
9	Zoom and Pan Tap to show zoom and pan function buttons. To zoom in and out, tap the magnifying glass; to pan in any direction, tap the arrow buttons. You can also tap the main map window to adjust the zoom level.

	Item	Description
⑩	Coverage theme	Displays the coverage and variety tracking settings. Height, coverage/overlap, variety, and GPS quality can be shown.

## Configuring the Row Guidance plugin on the FmX display

### Setting up the implement

Before starting the Row Guidance setup on the display, ensure that:

- All cables and components of the system are installed on the vehicle.
- The Autopilot system has been installed and configured with the NavController II firmware, version 5.20 or later.
- When setting up the Autopilot plugin for use with the RG-100 system, ensure that a vehicle profile that ends in **RY** is selected in the *Vehicle Controller Setup* screen and the XML header file in version 3.8 has been added to the vehicle profiles on the FmX integrated display.
- The Row Guidance plugin has been added to the FmX display configuration:
  1. In the Home screen, tap .
  2. In the *Configuration Selection* screen, tap the **Edit** button next to *Implement*.
  3. In the *Configuration* screen tap **Add/Remove** to add the plugin to the configuration.

### Setting up the plugin

1. In the *Configuration* screen, select the *Row Guidance* plugin and then tap **Setup**.  
The *Row Guidance Configuration* screen appears.
2. Once you are in the RG-100 setup, select the header model attached to your combine and verify that the measurements are accurate for your vehicle—measurements can differ due to vehicle variations.

3. Measure distances with the header at the approximate operation height. Inaccurate measurements will result in a degraded performance.

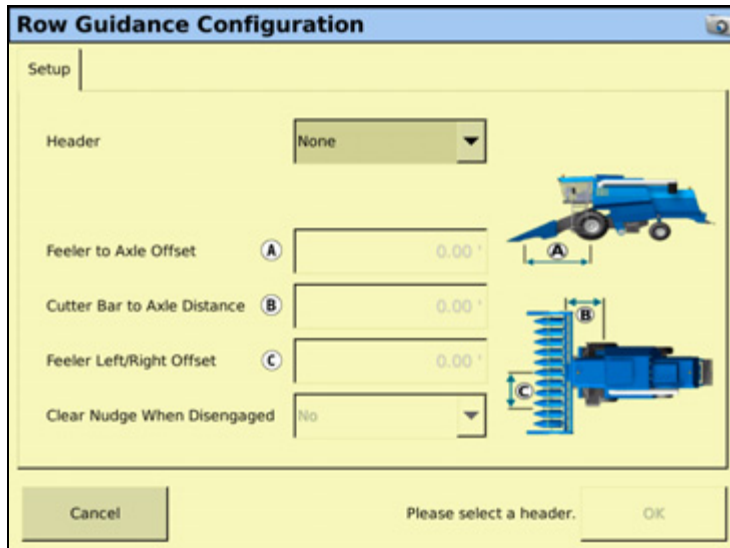

Setting	Description
Header	Select the type of head on the combine.
Feeler to Axle Offset	Enter the distance from the pivot point of the feeler to the front axle. This measurement must be accurate to within an inch, otherwise the performance will be degraded.
Cutter Bar to Axle Distance	Enter the distance from the front of the cutter bar or point where the crop enters the snapper rollers to the center of the front axle. This measurement must be accurate, otherwise the performance will be degraded.
Feeler Left/Right Offset	Enter the distance from the center of the gap between the two feelers to the centerline of the vehicle. A left offset appears as a negative number. A right offset appears as a positive number.
Clear Nudge When Disengaged	Select Yes to clear the AutoPilot nudges when the system is disengaged. Select No to keep the AutoPilot nudges when the system is disengaged.

### Row-Guidance Diagnostics screen

The Row Guidance Diagnostics screen displays the following:



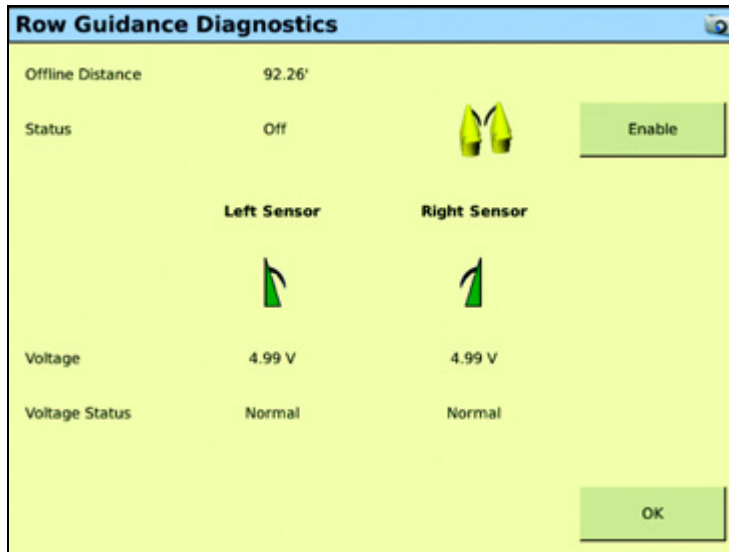

- Offline Distance Sensor status
- Sensor voltage
- Voltage status

You can also enable and disable sensors in this screen.



## Operating the Row Guidance plugin

### Status indicators

Setting	Description
	Sensors off
	Sensors on but not active
	Sensors on and active
	Error with sensors

Row Guidance can be operated with AB, Curves, and Freeform guidance patterns:

- AB lines operate as normal. Use either A-B or A+ heading.

- Freeform can be used so that, once recording and in corn, the row guidance sensors drive the first pass. From then on, the guidance system uses the previous recorded pass but augments it with sensor input.
- When using Curves, and operating on a sharp curve, row guidance aggressiveness may need to be increased for performance.

To turn row guidance sensors on and off while the Autopilot system is engaged, tap .

The guidance system will now function as a traditional Autopilot system.

**Note** – Row sensors override the set Autopilot guidance line. When turning around in headlands with the sensor turned on, random strikes on stubble cause the system to veer off the set Autopilot guidance line. It is recommended to travel through the headlands with Autopilot only to guide to the proper row. Once the unharvested crop is entered, turn on the row sensors.



**Tip** – When operating in crop that was planted manually or using WAAS guidance, and that is being harvested using WAAS guidance, satellite drift and/or operator guidance can lead to misalignment of the guidance line with the crop. Depending on conditions, it may be necessary to shift or skip the guidance line to coordinate with the crop and guidance line. This will be evident when the sensors guide down the proper row with offline distance is shown to be 0, but the selected guidance line is not centered on the current swath on the display.

## Connecting the system

Once the Row Guidance plugin has been installed, add the FmX integrated display as shown.

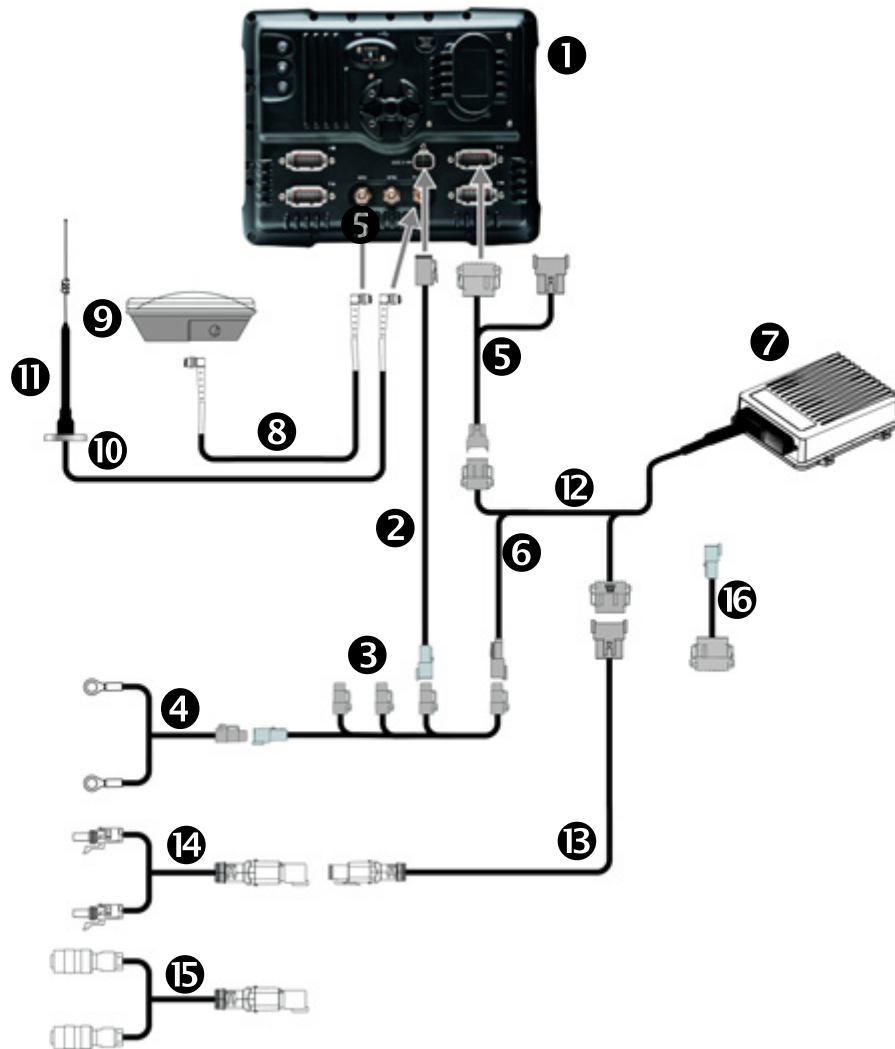

Item	Description	Trimble part number
1	Display	93000-xx
2	Display power cable	66694
3	Power relay	67259
4	Basic power cable	67258
5	Display to NavController II	75741
6	NavController II power adapter	67095
7	NavController II	52200-02
8	Antenna cable	

Item	Description	Trimble part number
9	AG15 GNSS antenna	77038-00
10	RTK antenna cable	
11	RTK antenna	
12	NavController II main harness	54601
13	RG-100 NavController II to feeder house cable	85538
14	RG-100 feeder house to JD sensors	85537
15	RG-100 feeder house to Claas/CNH sensors	85924
16	CNH adapter cable	85790

## EZ-Pilot assisted steering system guidance

The EZ-Pilot™ assisted steering system works with the FmX integrated display's internal GPS receiver to provide vehicle guidance.

### Installing the EZ-Pilot system

For information on installing the EZ-Pilot controller in your vehicle, refer to the supported vehicle-specific EZ-Pilot installation instructions.

## Connecting the EZ-Pilot system

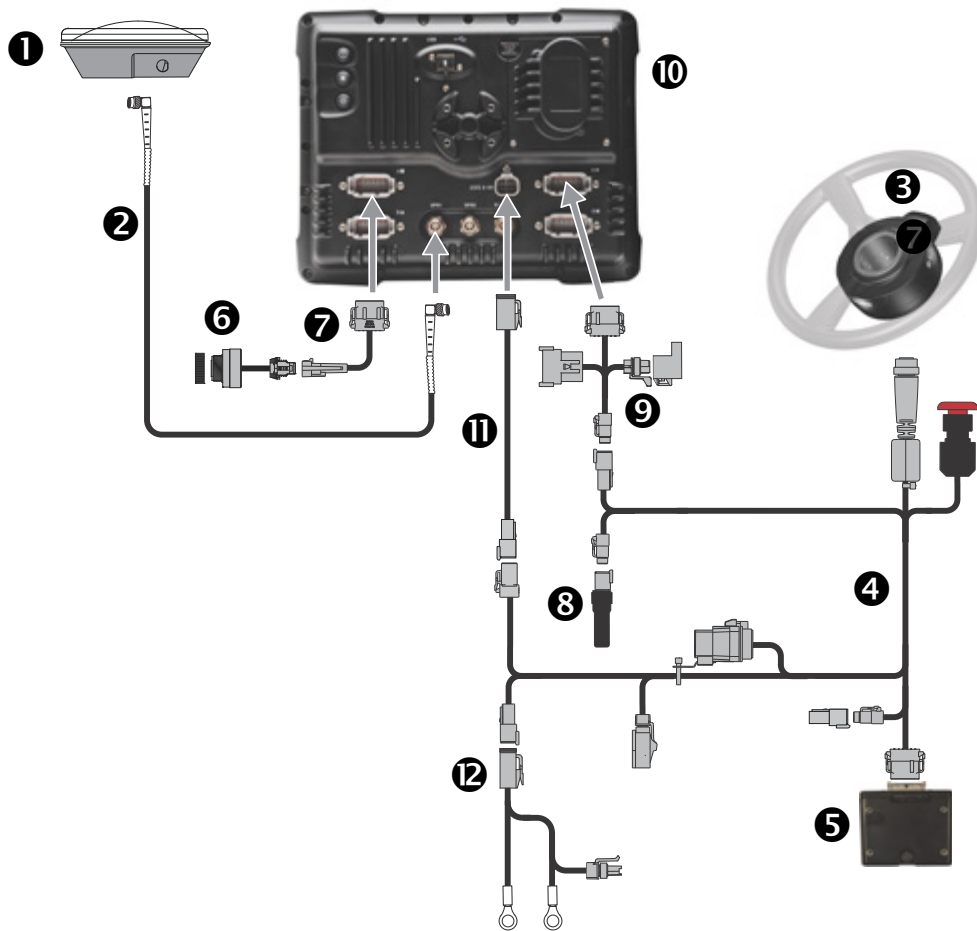

Item	Description	Trimble part number
①	Antenna	77038-00
②	Antenna cable	50449
③	SAM-200 steering motor	83382-xx
④	IMD-600 – SAM-200 to CAN power cable	76351
⑤	IMD-600	83390-xx
⑥	Display to Sonalert cable	84668
⑦	Sonalert	43104
⑧	FmX to Field-IQ cable	75834
⑨	CAN terminator	59783
⑩	FmX display	94100-xx
⑪	Basic power cable	77282
⑫	Basic power cable	67258



1. Use the FmX to EZ-Pilot cable to connect the EZ-Pilot system to the display.

*Note – The CAN cable connects to either the C or D port on the rear of the FmX integrated display.*

*Note – Connect the Display to Sonalert cable to Port A on the back of the display.*

2. Mount the IMD-600 as show in the platform kit instructions for the approved platform in which EZ-Pilot is being installed.

## Setup

1. Install the EZ-Pilot system plugin ( for more information, see the *FmX integrated display Plug-ins guide*).

2. From the *Configuration* screen, select the EZ-Pilot plugin and then tap **Setup**.

The *EZ-Pilot Settings* screen contains four tabs: *Vehicle*, *Engage*, *Steering*, and *Advanced*.

## Vehicle tab

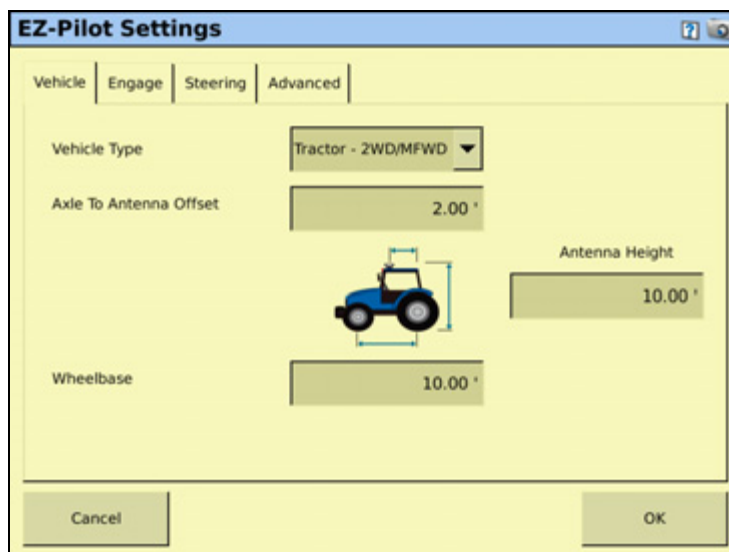

Setting	Description
Vehicle type	The type of vehicle the EZ-Pilot system will be steering.
Wheelbase	<p>The distance between the front and rear axles. On tracked vehicles, the wheelbase is exactly half the length of the track.</p> <ul style="list-style-type: none"> <li>• If the antenna is in front of the axle, enter a Forward distance.</li> <li>• If the antenna is behind the axle enter a Back distance.</li> </ul> <p><b>Note – It is recommended that you measure the offset distance as accurately as possible (within 3"); an incorrect offset may cause poor steering performance.</b></p>

Setting	Description
Axle to Antenna Offset	<p>Center (the axle) of the front or rear wheel to the top of the GPS antenna.</p> <p><b>Note</b> – Make sure that you take this measurement to within 7.6 cm (3 in.) as an incorrect distance may result in poor steering performance.</p> <p>Take the measurement from the antenna to the correct point of your vehicle, as follows:</p> <p><b>Rear axle:</b></p> <ul style="list-style-type: none"> <li>• MFWD</li> <li>• Sprayer</li> <li>• Floater</li> <li>• Truck</li> </ul> <p><b>Front axle:</b></p> <ul style="list-style-type: none"> <li>• 4WD tractor</li> <li>• Combine</li> </ul> <p><b>Track center:</b></p> <ul style="list-style-type: none"> <li>• Tracked tractor</li> </ul> <p>If the antenna is:</p> <ul style="list-style-type: none"> <li>• in <b>front</b> of the axle, enter a <b>Forward</b> distance</li> <li>• <b>behind</b> the axle, enter a <b>Behind</b> distance</li> </ul>
Antenna Height	The distance between the ground and the top of the GPS antenna.

### Engage tab

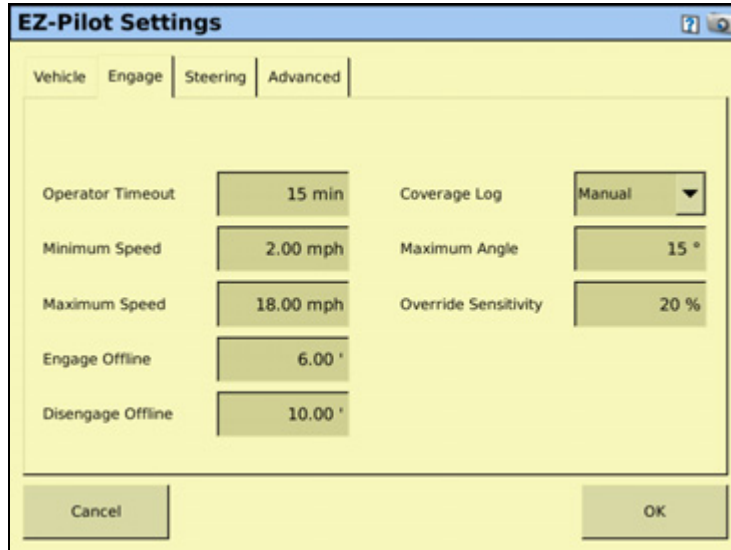

The *Engage* tab enables you to control the system’s engage and disengage behavior if you need to change the automatically populated settings.

Section	Description
Operator timeout	If the steering system is engaged and there has been no operator input to the display for longer than the operator timeout period, a message appears on the screen. If you acknowledge the message within 30 seconds, the system does not disengage.

Section	Description
Minimum speed	Minimum speed at which the system can engage. If the system is engaged and the speed drops below this limit, the system disengages.
Maximum speed	Maximum speed at which the system can engage. If the system is engaged and the speed increases above this limit, the system disengages.
Maximum angle	Maximum angle at which the system can engage. If the vehicle approaches the swath at an angle greater than this limit, it cannot be engaged.
Engage offline	Maximum distance from the swath at which the system can engage. If the vehicle approaches the swath at a distance greater than this limit, it cannot be engaged.
Disengage offline	Maximum distance from the swath at which the system can remain engaged. If the vehicle drives offline greater than this limit, the system disengages.
Coverage log	Appears on the Run screen to show what areas have been applied. <ul style="list-style-type: none"> <li>• Select <i>When Engaged</i> to automatically show coverage logging when the system is engaged.</li> <li>• Select <i>Manual</i> to show coverage logging only when you tap .</li> </ul>
Override sensitivity	Amount the steering wheel must be turned manually before the system disengages.

## Steering tab

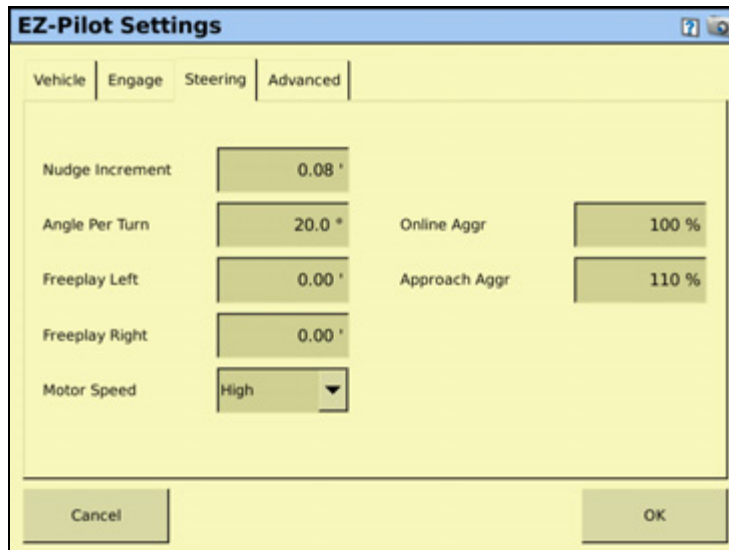

Section	Description
Nudge Increment	The distance the Nudge button on the Run screen moves the line back to the correct path.
Angle per Turn	The angle that the wheels turn during one full rotation of the steering wheel. <ul style="list-style-type: none"> <li>• If the setting is too low, the system will turn the wheel too much and the vehicle will perform s-turns.</li> <li>• If the setting is too high, the system will turn the wheel too little and the vehicle will not hold the line.</li> </ul>
Freeplay Left	Adjust this setting if the vehicle drives consistently to the right of the line.
Freeplay Right	Adjust this setting if the vehicle drives consistently to the left of the line.
Motor Speed	Set the maximum rate at which the SAM-200 will operate.

Section	Description
Online Aggr	<p>How aggressively the EZ-Pilot system corrects deviations from the current guidance line.</p> <ul style="list-style-type: none"> <li>• A very high setting will correct deviations quickly but the vehicle may steer erratically.</li> <li>• A very low setting will allow a smoother drive down the swath but the vehicle may go further offline before the deviation is corrected.</li> </ul>
Approach Aggr	<p>How quickly the EZ-Pilot system steers the vehicle onto the current guidance line.</p> <ul style="list-style-type: none"> <li>• A very high setting steers the vehicle quickly, but the steering correction may be too severe.</li> <li>• A very low setting steers the vehicle very slowly, but the vehicle may overshoot and travel too far down the swath before reaching the guidance line.</li> </ul>

### Advanced tab

*Note* – For more information on how to use the features in the Advanced tab, contact your local reseller.

## Calibrating and configuring the EZ-Pilot system

The calibration configures the T3™ roll calibration and the EZ-Pilot system *Angle per Turn*, *Aggressiveness*, and *Freeplay* settings.

Before you calibrate the vehicle, do the following:

- Ensure that the vehicle's hydraulic oil is up to operating temperature. Refer to the vehicle documentation.
- Ensure that the tire pressure is correct.
- Perform initial calibration without an implement or with the booms folded in on a high-clearance sprayer. After initial calibration is completed, you can fine tune the settings with the implement or booms folded out.
- Choose a field with the smoothest possible surface and perform calibration at the normal operating speed for the vehicle.

The EZ-Pilot calibration process requires an open field in which the vehicle can make right and left turns and also travel down a straight A-B line. If you do not create an A-B line before you begin the calibration, the system prompts you to open a field and create one.

### Calibrating the EZ-Pilot system

To calibrate the EZ-Pilot system to work with the FmX integrated display, you must complete the following:

1. Enter the vehicle settings. See [page 145](#).
2. Calibrate T3 roll compensation. See [page 149](#).
3. Calibrate the EZ-Pilot system. See [page 151](#):

- Angle per Turn
  - Aggressiveness
  - Freeplay offset
4. Confirm the calibration settings.

**Note** – You may have to perform the EZ-Pilot calibration more than once to achieve optimal results.

### Calibrating T3 roll compensation

The EZ-Pilot system contains sensors that use T3 terrain compensation technology to provide roll compensation when the vehicle is on a slope or drives over a bump. For roll compensation to work correctly, the IMD-600 must be calibrated.

1. Select the EZ-Pilot plugin and then tap **Calibrate**:

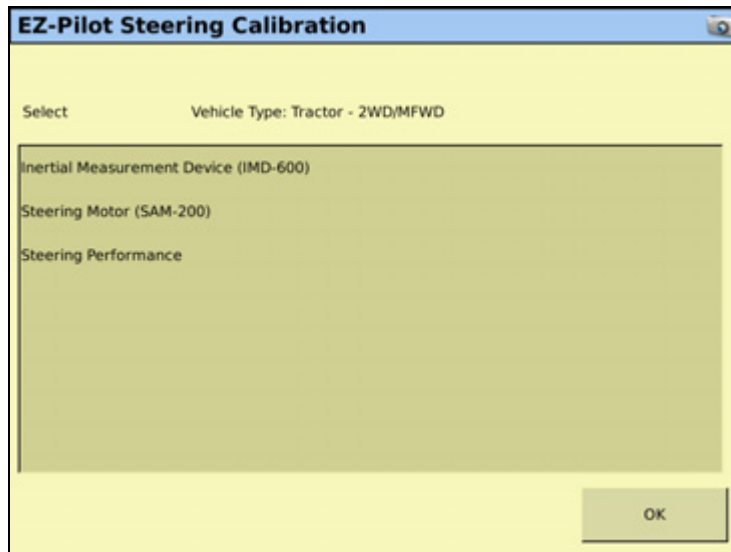

2. Select *IMD-600 Orientation*:

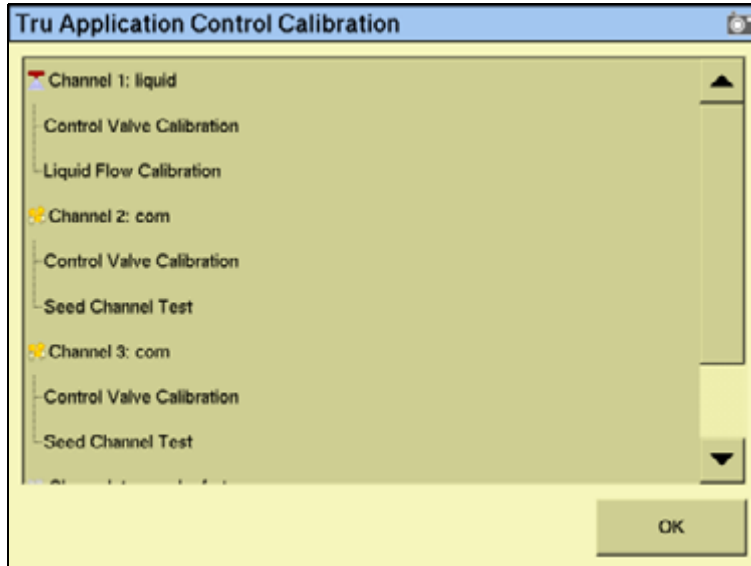

**Note** – For best accuracy, install the IMD-600 as shown in the installation instructions for the supported platform in which it is being installed. Make sure the IMD-600 is installed at right angles to the center line of the vehicle. Non-orthogonal angles will cause performance degradation.

3. From the *Orientation* drop-down list, select the orientation of the IMD-600 module and then tap **Next**:

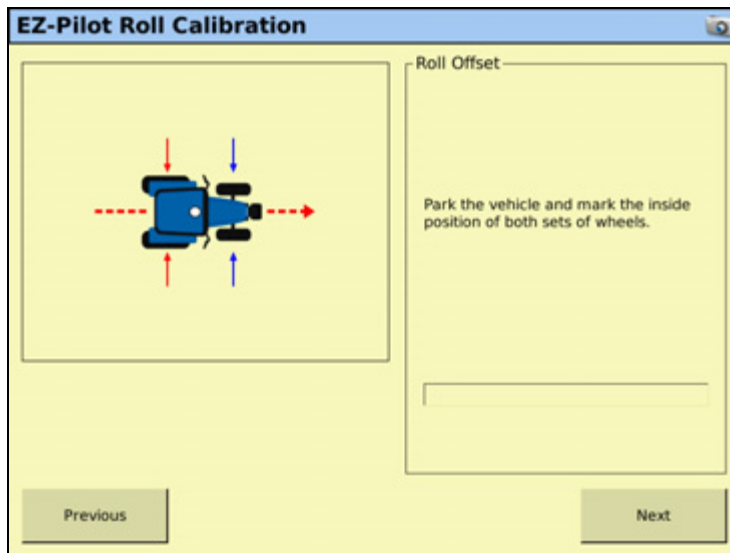

4. Park the vehicle, mark the inside position of both sets of wheels and then tap **Next**.  
The display records the roll offset in the first direction. This takes approximately 20 seconds. Do not move the vehicle while the offset is being read.

5. Turn the vehicle around, ensure the wheels are parked over the marks created in Step 4 and then tap **Next**.

The display records the roll offset in the second direction. This takes approximately 20 seconds. Do not move the vehicle while the offset is being read.

6. The T3 calibration results will appear in the *Roll Offset* screen. The Roll Offset value should be between 0° and 4°.
7. Tap **OK**. The *EZ-Pilot Steering Calibration* screen appears.

### Calibrating the SAM-200

#### **Notes:**

*Ensure that you are operating the vehicle in an open field with ample area for the vehicle to make right and left turns.*

*You must calibrate the IMD-600 **before** you calibrate the SAM-200.*

*For best results, operate the vehicle at between 2 and 4 mph.*

To calibrate the right turn angle:

1. Drive straight forward until the  icon appears and then tap it.
2. Allow the system to operate for 20 seconds until you receive a message that the calibration is complete.

Repeat the procedure to calibrate the left turn angle.

### Calibrating and setting the EZ-Pilot parameters

To calibrate the EZ-Pilot system, and set the correct steering performance parameters, the following steps must be completed with the vehicle moving forward along the A-B line.

1. From the *EZ-Pilot Steering Calibration* screen, select *Steering Performance*. The *EZ-Pilot Steering Performance* screen appears.

2. Tap the *Override Sensitivity* tab:

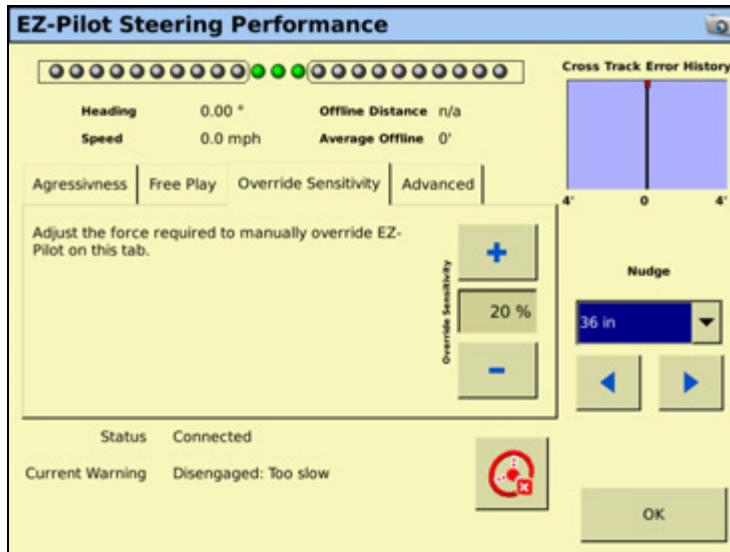

3. To control the amount of force that is required to disengage the system, tap the *Aggressiveness* tab::

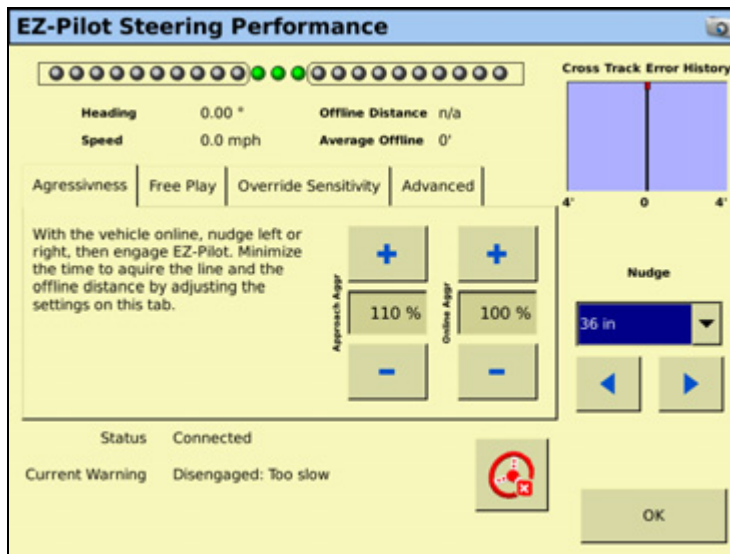

The *Aggressiveness* setting fine-tunes how aggressively the system holds the line. If the setting is too low, the vehicle will not hold the line; if the setting is too high, the vehicle may over-correct and make S-turns.

4. Adjust the *Aggressiveness* setting to get the vehicle as close to the line as possible without going into S-turns.

To make...	Do the following...
More aggressive turns	Increase the <i>Aggressiveness</i> value.
Less aggressive turns	Decrease the <i>Aggressiveness</i> value.



5. Tap the *Free Play* tab:

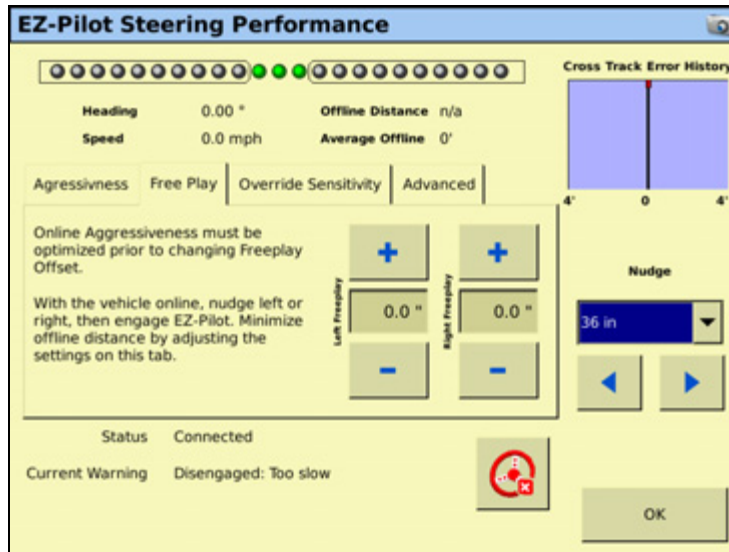

Add a Freeplay Offset if the steering has greater freeplay in one direction than the other, causing it to drive consistently to one side of the guidance line.

6. Engage the system on the A–B line.

Vehicle is offline...	Do the following...
To the left	Increase the freeplay offset to the right.
To the right	Increase the freeplay offset to the left.

**Note** – If you are calibrating a 4WD articulated vehicle, you may need to set the Motor Speed setting to Auto Low.

**Note** – The Advanced Calibration tab is currently not available. To access these options, select the EZ-Pilot plugin **Diagnostics** from the main Configuration screen.

7. Enter the parameters and then tap **OK**. The *EZ-Pilot Steering Calibration* screen appears.
8. Tap **OK**. The *Configuration* screen appears.

## EZ-Pilot plugin diagnostics

The *EZ-Pilot Diagnostics* screen displays the statistics for the IMD-600 and SAM-200 and inertial information.

1. From the *Configuration* screen, select the EZ-Pilot plugin and then tap **Diagnostics**. The *EZ-Pilot Diagnostics* screen appears:

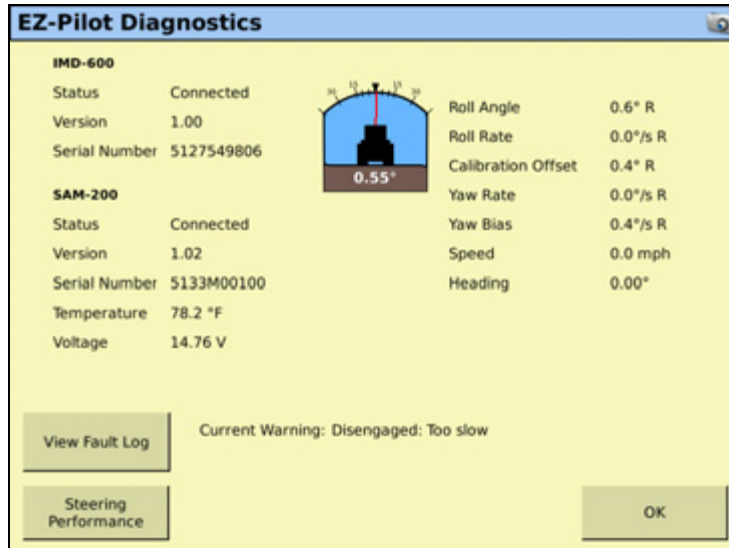

2. Tap **Steering Performance**. The *EZ-Pilot Steering Performance* screen appears.

The *Advanced* tab is for advanced users who understand how to adjust EZ-Pilot performance. If you are not an advanced user, follow the tabs in the given order to adjust the steering parameters. See [Calibrating and setting the EZ-Pilot parameters, page 151](#):

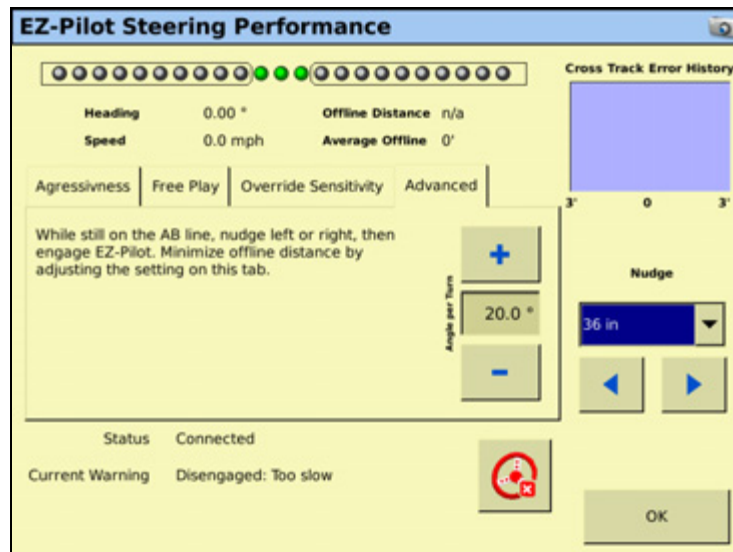

3. In the *Advanced* tab, make the required changes and then tap **OK**. The *Configuration* screen appears.

## Operating the EZ-Pilot system with the FmX integrated display

**Note** – When operating the vehicle in transport or on a public roadway, the red EZ-Pilot override switch must be in the off (down) position.

### Engaging the system

To engage the EZ-Pilot system, you must have an open field in the Run screen, and have an A–B line defined. The vehicle must be within the engage limits configured in the *Engage* tab.

To manually engage the EZ-Pilot system, tap the engage button on the main guidance screen, or press the engage button on the optional remote control.

### Disengaging the system

Turning the steering wheel manually disengages the EZ-Pilot system. It is recommended that you check this setting before you start using the system in a new installation by engaging on a line and then turning the wheel until EZ-Pilot disengages. To adjust the amount of force required to disengage the system, change the *Override Sensitivity* in the *EZ-Pilot Setup* screen. The EZ-Pilot system automatically disengages when:

- The vehicle is outside the engage limits configured in the *Engage Options* screen.
- The system is paused.

- GPS positions are lost.
- The *Minimum Fix Quality* setting is set to a high accuracy correction method and the system receives low accuracy positions ( for example, no corrections).
- To manually disengage the system, do one of the following:
  - Tap the engage button on the main guidance screen or press the engage button on the optional remote control.
  - Turn the steering wheel to override the electric motor.

### EZ-Pilot plugin screen

The EZ-Pilot tab on the Run screen shows the current nudge increment and online aggressiveness values.

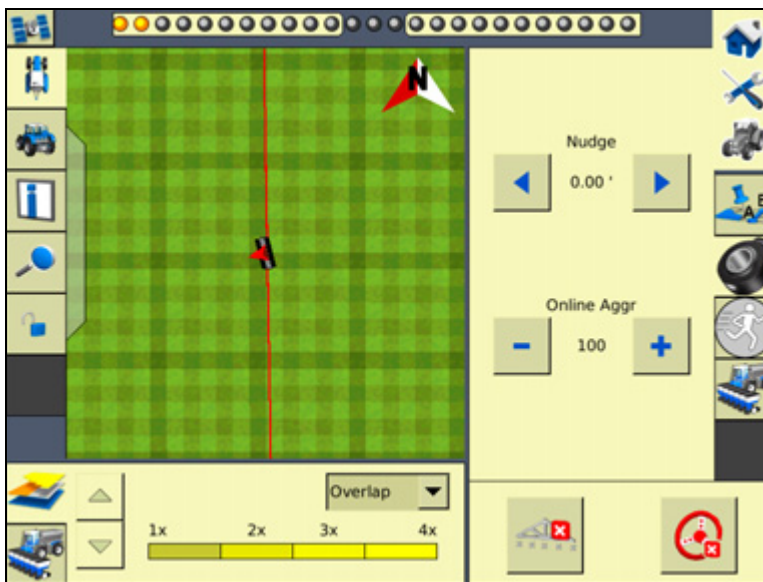

- Tap either the < or > button to increase or decrease the *Nudge Increment* setting by the distance set in the *Steering Settings* setup screen.
- Tap either the - or + button to increase or decrease the Online Aggressiveness setting by  $\pm 5\%$ . The default value is set in the *Steering Settings* setup screen.

## Vehicle-specific performance

Before you use the EZ-Pilot system, it is recommended that you consider the following vehicle-specific performance suggestions.

Vehicle type	Performance hint
2WD tractor	<p>For an EZ-Pilot system installed on tractors that have SuperSteer (for example, New Holland TG). If the tractor has a SuperSteer front axle, for best performance:</p> <ul style="list-style-type: none"> <li>• Reduce the Online Aggressiveness value.</li> <li>• Line up close to the swath and make certain that the front wheels are straight before engaging the EZ-Pilot system.</li> <li>• To get smoother performance when the vehicle is pulling an implement over tilled ground, enable the Diff-Lock. This prevents the machine from pulling sharply to the left or right. If you are calibrating on a hard surface, turn off Diff-Lock.</li> </ul>
4WD tractor	<p>The EZ-Pilot system can be installed on Case IH STX tractors with Accusteer. For optimal performance, disable Accusteer using the switch in the cab (if possible).</p>
Sprayer	<ul style="list-style-type: none"> <li>• It is common for these vehicles to have slow steering. To compensate for this, use high aggressiveness.</li> <li>• If you experience large, slow oscillations, increase the aggressiveness.</li> <li>• When you configure the system on a sprayer, the Sprayer steering delay setting is available on the <i>Vehicle Setup</i> screen.</li> <li>• Some sprayers have steering that is slow to react after you turn the steering wheel. The system uses the steering delay setting to compensate for this slowness and ensure that steering corrections occur at the correct point.</li> </ul>
Swather	<ul style="list-style-type: none"> <li>• When you configure the system on a swather, the Swather steering delay setting is available on the <i>Vehicle Setup</i> screen.</li> <li>• Some swathers have steering that is slow to react after the steering wheel is turned. The system uses the steering delay setting to compensate for this slowness and ensure that steering corrections occur at the correct point.</li> <li>• To improve the performance of your swather, adjust the Swather steering delay setting by a small amount (0.1 seconds) at a time. Test the result between each adjustment</li> </ul>

## After using the EZ-Pilot system

After you finish using the EZ-Pilot system, do the following:

- **Before** you leave the vehicle, turn off the power to the display to turn off the EZ-Pilot system .
- For road travel, the red EZ-Pilot override button must be in the off (down) position.

## EZ-Steer assisted steering system guidance

The EZ-Steer<sup>®</sup> assisted steering system works with the FmX integrated display's internal GPS receiver to provide vehicle guidance.

### Installing the EZ-Steer controller

For information on installing the EZ-Steer controller in your vehicle, refer to the *EZ-Steer Assisted Steering System Getting Started Guide* and the *EZ-Steer Assisted Steering System Installation Instructions*.

### Connecting the EZ-Steer system

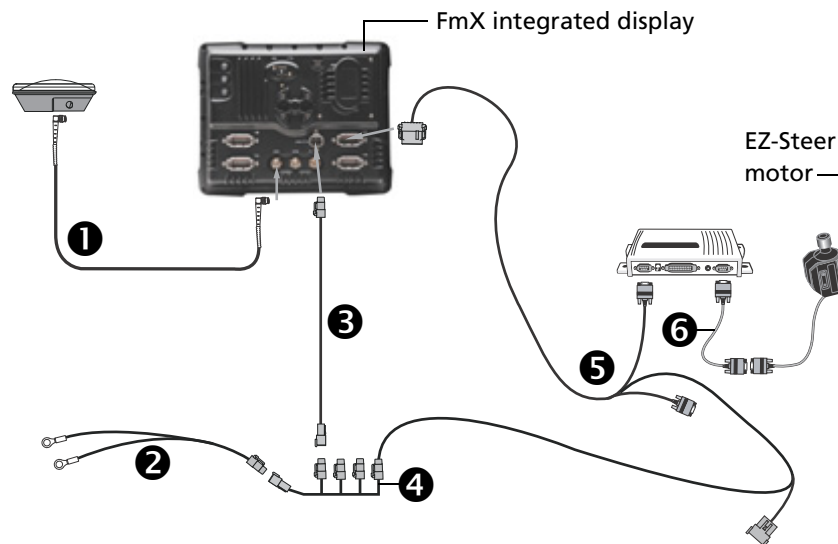

Item	Description	Trimble part number
1	Antenna cable	50449
2	FmX basic power cable	67258
3	FmX power cable	66694
4	FMX power bus	67259
5	FmX to EZ-Steer cable	75742
6	EZ-Steer motor cable	62257

1. Use the FmX to EZ-Steer cable to connect the EZ-Steer system to the display.

**Note** – The CAN cable connects to either the C or D port on the rear of the FmX integrated display.

2. Attach the EZ-Steer controller to the dash. Use the provided bracket.

## Calibrating and configuring the EZ-Steer system

The calibration configures the T2™ roll calibration and the EZ-Steer system *Angle per Turn*, *Aggressiveness*, and *Freeplay* settings.

Before you calibrate the vehicle, do the following:

- Ensure that the vehicle's hydraulic oil is up to operating temperature. Refer to the vehicle documentation.
- Ensure that the tire pressure is correct.
- Perform initial calibration without an implement or with the booms folded in on a high-clearance sprayer. After initial calibration is completed, you can fine tune the settings with the implement or booms folded out.
- Choose a field with the smoothest possible surface and perform calibration at the normal operating speed for the vehicle.

The EZ-Steer calibration process requires a straight A–B line. If you do not create an A–B line before you begin the calibration, the system prompts you to open a field and create one.

### Calibrating the EZ-Steer system

To calibrate the EZ-Steer system to work with the FmX integrated display, you must complete the following:

1. Enter the vehicle settings. See [page 159](#).
2. Calibrate T2 roll compensation. See [page 161](#).
3. Calibrate the EZ-Steer system. See [page 163](#):
  - Angle per Turn
  - Aggressiveness
  - Freeplay offset
4. Confirm the calibration settings.

**Note** – You may have to perform the EZ-Steer calibration more than once to achieve optimal results.

### Entering vehicle settings

1. Install the EZ-Steer system plugin ( for more information, see the *FmX integrated display Plug-ins guide*).
2. From the *Configuration* screen, select the EZ-Steer plugin and then tap **Setup**.

The *EZ-Steer Settings* screen appears:

The screenshot shows the 'EZ-Steer Settings' window with the following fields and values:

- Vehicle Type: Tractor - 2WD/MFWD
- Axle To Antenna Offset: 0.00 m
- Antenna Height: 0.00 m
- Wheelbase: 0.00 m
- Vehicle Color: Red

At the bottom of the window are 'Cancel' and 'OK' buttons.

3. From the *Vehicle Type* drop-down list, select the vehicle type.
4. In the *Axle To Antenna Offset* field, enter the horizontal distance between the axle and the antenna:
  - If the antenna is in front of the axle, enter a *Forward* distance.
  - If the antenna is behind the axle enter a *Back* distance.

**Note** – Measure the offset distance as accurately as possible (within 3"); an incorrect offset may cause poor steering performance.

5. In the *Antenna Height* field, enter the height of the antenna, measured from the ground to the base of the antenna.
6. In the *Wheelbase* field, enter the wheelbase measurement (horizontal distance between the front and rear axles).

**Note** – The *Engage*, *Steering*, and *Advanced* tabs on this screen are populated automatically with starting values, based on the vehicle type selected.

7. Tap **OK**. The *Configuration* screen appears.



## Calibrating T2 roll compensation

The EZ-Steer system contains sensors that use T2 terrain compensation technology to provide roll compensation when the vehicle is on a slope or drives over a bump. For roll compensation to work correctly, the controller must be calibrated.

1. Select the EZ-Steer plugin and then tap **Calibrate**:

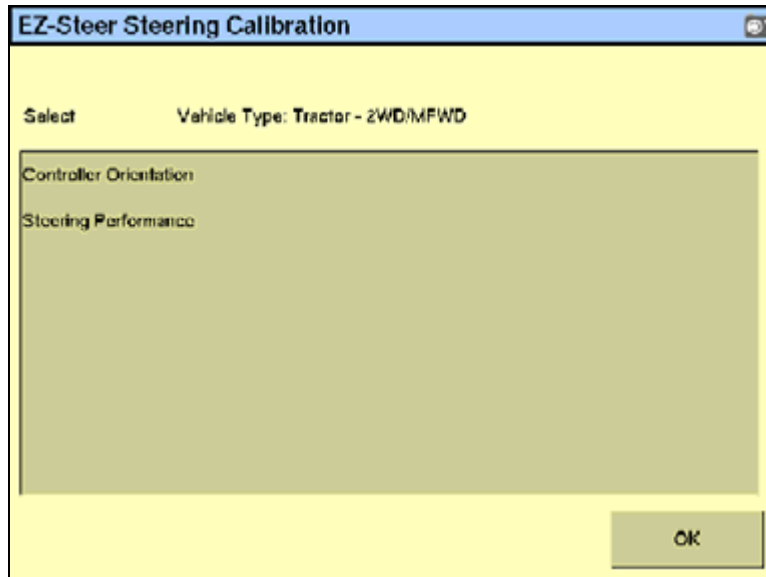

2. Select *Controller Orientation*:

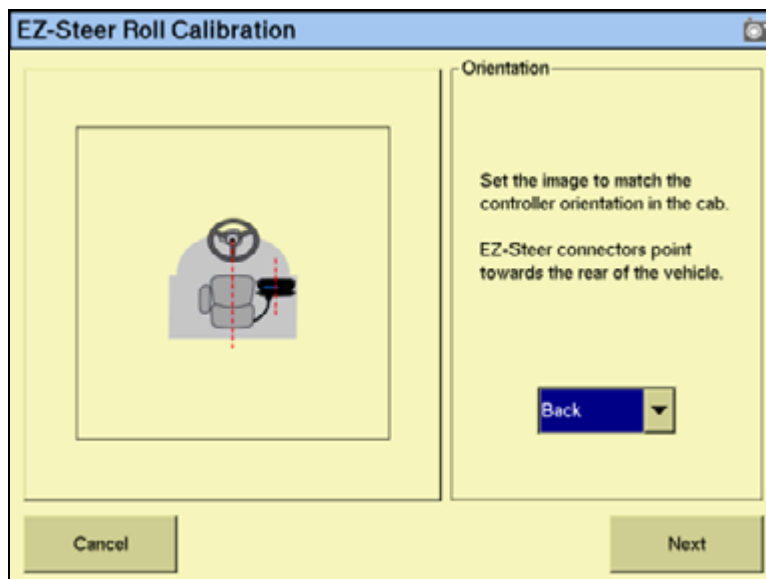

- From the *Orientation* drop-down list, select the orientation of the SCM (steering control module) and then tap **Next**:

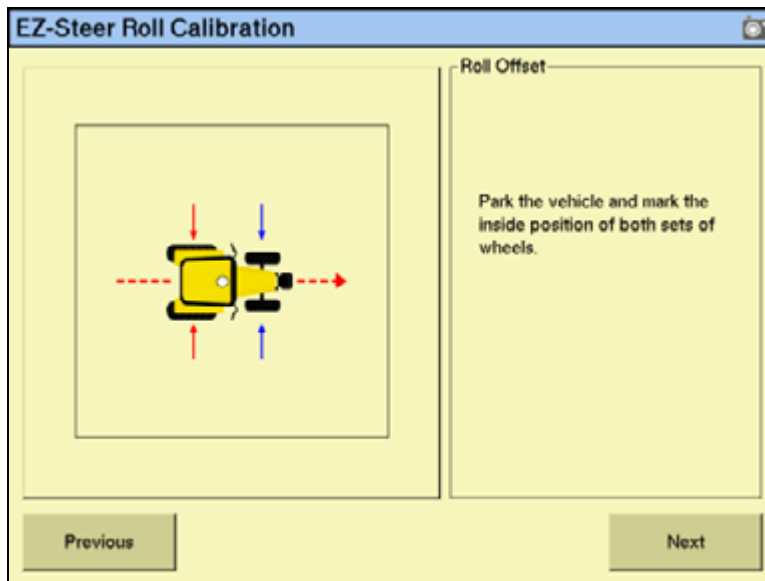

- Park the vehicle, mark the inside position of both sets of wheels and then tap **Next**.  
The display records the roll offset in the first direction. This takes approximately 20 seconds. Do not move the vehicle while the offset is being read.
- Turn the vehicle around, ensure the wheels are parked over the marks created in Step 4 and then tap **Next**:

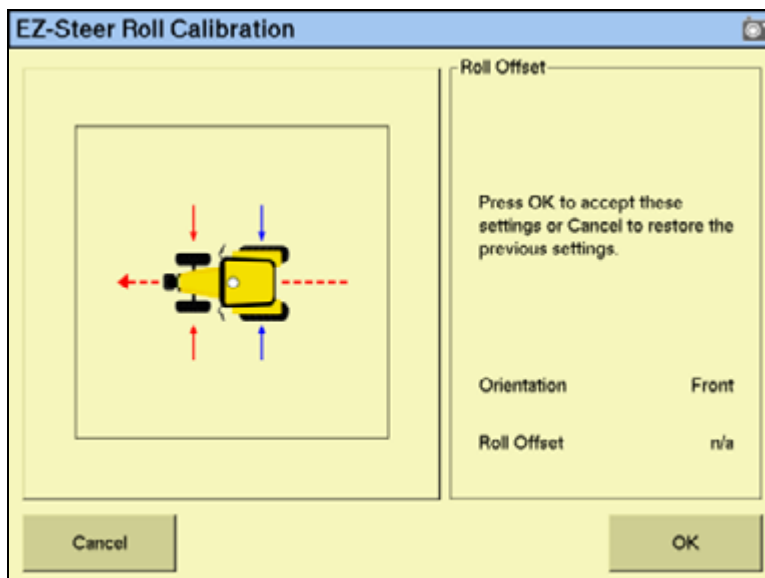

The display records the roll offset in the second direction. This takes approximately 20 seconds. Do not move the vehicle while the offset is being read.

6. The T2 calibration results will appear in the *Roll Offset* window. The Roll Offset value should be between 0° and 4°.
7. Tap **OK**. The *EZ-Steer Steering Calibration* screen appears.

### Calibrating and setting the EZ-Steer parameters

To calibrate the EZ-Steer system, and set the correct steering performance parameters, the following steps must be completed with the vehicle moving forward along the A-B line.

1. From the *EZ-Steer Steering Calibration* screen, select *Steering Performance*. The *EZ-Steer Steering Performance* screen appears.
2. To configure the *Angle per Turn* settings, select the *Step 1* tab:

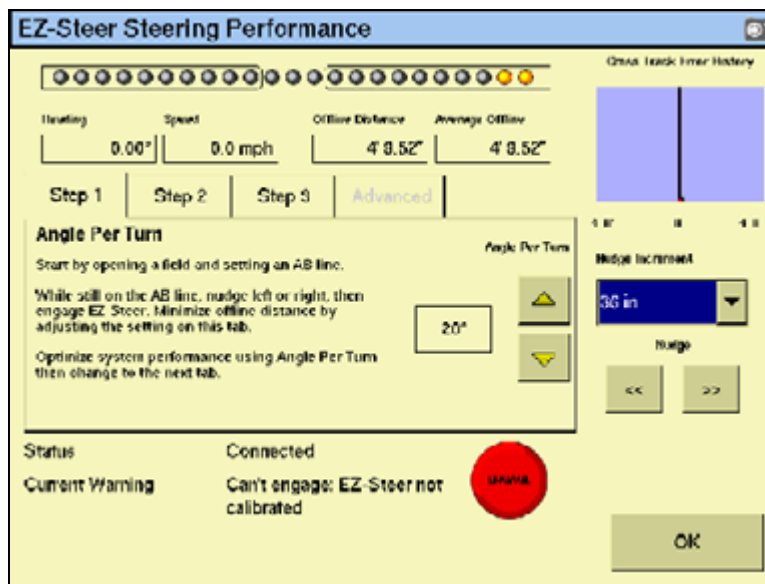

This is the angle that the wheels turn through during one full rotation of the steering wheel. This is a course aggressiveness adjustment. If the setting is too low, the system may require several attempts to reach the line.

With the vehicle moving forward along the A–B line:

- a. Nudge the vehicle left or right 1 m (3') from the A–B line.
- b. Engage the EZ-Steer system.
- c. Adjust the *Angle per Turn* value so that when the system is engaged, the vehicle moves close to the guidance line.

To make...	Do the following...
More aggressive turns	Decrease the <i>Angle per Turn</i> value.
Less aggressive turns	Increase the <i>Angle per Turn</i> value.

**Note** – Use the *Cross Track Error history* plot on the top right of the page and the *Average Offline distance* to optimize EZ-Steer performance for each step in the calibration.

- To configure the *Aggressiveness* settings, select the *Step 2* tab:

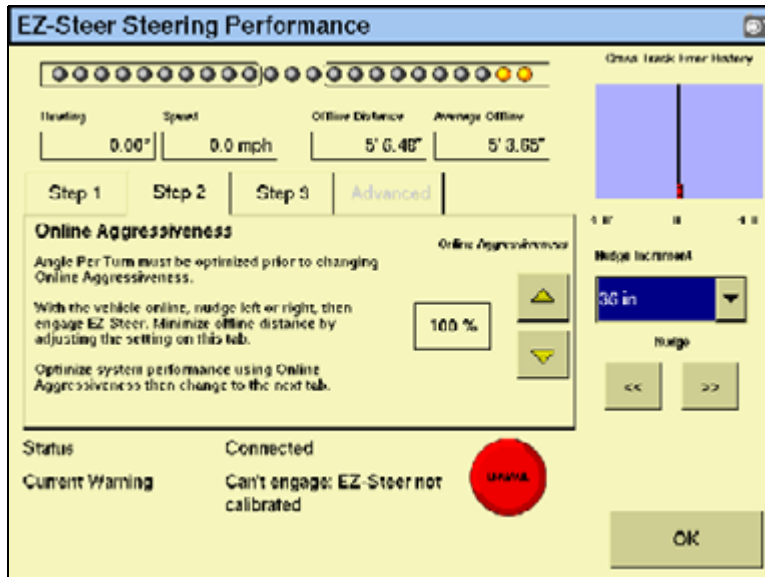

The *Aggressiveness* setting fine-tunes how aggressively the system holds the line. If the setting is too low, the vehicle will not hold the line; if the setting is too high, the vehicle may over-correct and make S-turns.

- Adjust the *Aggressiveness* setting to get the vehicle as close to the line as possible without going into S-turns.

To make...	Do the following...
More aggressive turns	Increase the <i>Aggressiveness</i> value.
Less aggressive turns	Decrease the <i>Aggressiveness</i> value.

- To adjust the *Freeplay Offset* settings, select the *Step 3* tab:

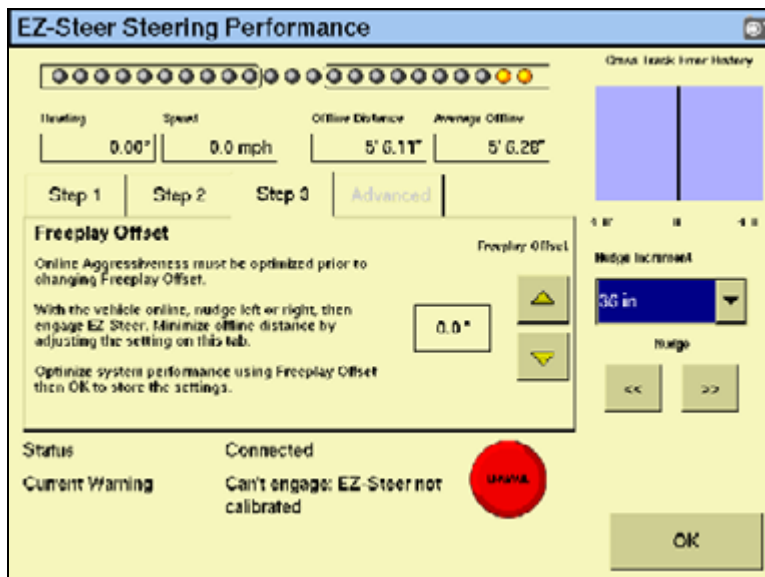

Add a Freeplay Offset if the steering has greater freeplay in one direction than the other, causing it to drive consistently to one side of the guidance line.

- Engage the system on the A-B line.

Vehicle is offline...	Do the following...
To the left	Increase the freeplay offset to the right.
To the right	Increase the freeplay offset to the left.

**Note** – If you are calibrating a 4WD articulated vehicle, you may need to set the Motor Speed setting to Auto Low.

**Note** – The Advanced Calibration tab is currently not available. To access these options, select the EZ-Steer plugin **Diagnostics** from the main Configuration screen.

- Enter the parameters and then tap **OK**. The EZ-Steer Steering Calibration screen appears.
- Tap **OK**. The Configuration screen appears.

### EZ-Steer plugin diagnostics

The EZ-Steer Diagnostics screen displays the SCM statistics and inertial information.

- From the Configuration screen, select the EZ-Steer plugin and then tap **Diagnostics**. The EZ-Steer Diagnostics screen appears.

This screen displays the roll and heading of the vehicle, and the temperature of the steering control module:

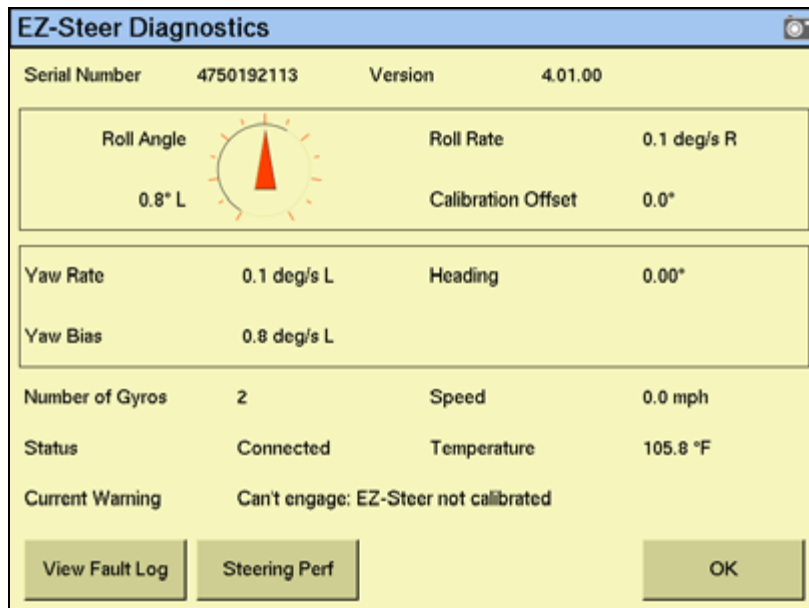

2. Tap **Steering Perf.** The *EZ-Steer Steering Performance* screen appears.

This screen is for advanced users who understand how to adjust EZ-Steer performance. If you are not an advanced user, it is recommended that you follow the numbered tabs to adjust the steering parameters. See [Calibrating and setting the EZ-Steer parameters](#), page 163:

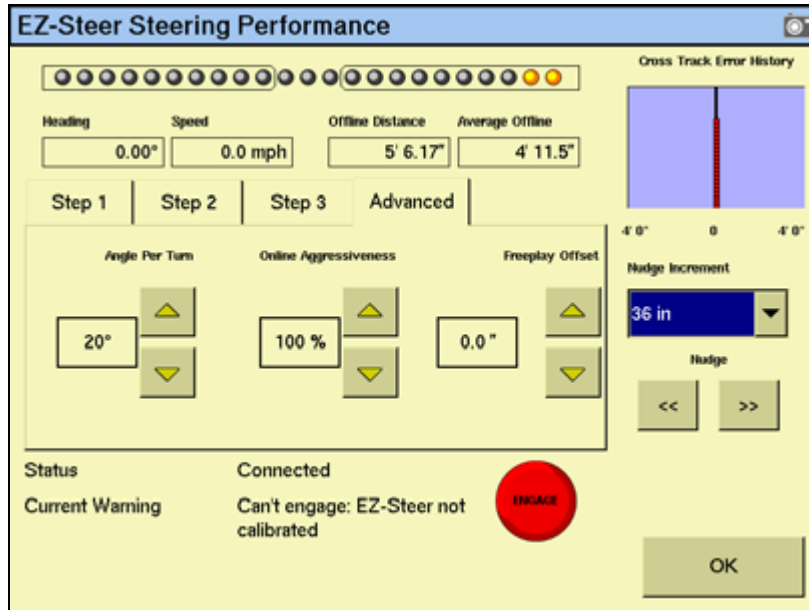

3. In the *Advanced* tab, make the required changes and then tap **OK**. The *Configuration* screen appears.

## Operating the EZ-Steer system with the FmX integrated display

### Engage options

The *Engage Options* tab enables you to control the system's engage and disengage behavior if you need to change the automatically populated settings.

1. From the *Configuration* screen, select the EZ-Steer plugin and then tap **Setup**. The *EZ-Steer Settings* screen appears.
2. Select the *Engage Options* tab. The following options appear:

Option	Description
Minimum speed	Minimum speed at which the system can engage. If the system is engaged and the speed drops below this limit, the system disengages.
Maximum speed	Maximum speed at which the system can engage. If the system is engaged and the speed increases above this limit, the system disengages.
Maximum angle	Maximum angle at which the system can engage. If the vehicle approaches the swath at an angle greater than this limit, it cannot be engaged.

Option	Description
Engage offline	Maximum distance from the swath at which the system can engage. If the vehicle approaches the swath at a distance greater than this limit, it cannot be engaged.
Disengage offline	Maximum distance from the swath at which the system can remain engaged. If the vehicle drives offline greater than this limit, the system disengages.
Engage on A-B	Configure whether the system can be engaged on the master A-B line.
Override sensitivity	Amount the steering wheel must be turned manually before the system disengages.
EZ-Steer external switch	Configure the behavior of a seat/foot switch.

3. Configure the *Engage Options* as required and then tap **OK**. The *Configuration* screen appears.

## Engaging the system

To engage the EZ-Steer system, you must have an open field in the Run screen, and have an A-B line defined. The vehicle must be within the engage limits configured in EZ-Steer systems *Engage Options*.

To manually engage the EZ-Steer system, do one of the following:

- Tap the engage button on the main guidance screen, or press the engage button on the optional remote control.
- Press the optional remote engage foot pedal.

## Disengaging the system

Turning the steering wheel manually disengages the EZ-Steer system. It is recommended that you check this setting before you start using the system in a new installation by engaging on a line and then turning the wheel until EZ-Steer disengages. To adjust the amount of force required to disengage the system, change the *Override Sensitivity* in the *EZ-Steer Setup* screen. The EZ-Steer system automatically disengages when:

- The vehicle is outside the engage limits configured in the *Engage Options* screen.
- The system is paused.
- GPS positions are lost.
- The *Minimum Fix Quality* setting is set to a high accuracy correction method and the system receives low accuracy positions (for example, no corrections).
- To manually disengage the system, do one of the following:
  - Tap the engage button on the main guidance screen or press the engage button on the optional remote control.
  - Turn the steering wheel to override the electric motor.
  - Press the optional remote engage foot pedal.

When the system is not in use, hinge the motor away from the steering wheel and then secure it with the lock pin.

### EZ-Steer plugin screen

The EZ-Steer tab on the Run screen shows the current nudge increment and online aggressiveness values.

- Tap either the < or > button to increase or decrease the *Nudge Increment* setting by the distance set in the *Steering Settings* setup screen.
- Tap either the - or + button to increase or decrease the Online Aggressiveness setting by +/- 5%. The default value is set in the *Steering Settings* setup screen.

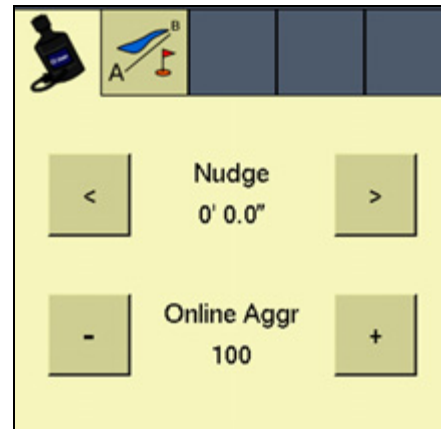

### Vehicle-specific performance

Before you use the EZ-Steer system, it is recommended that you consider the following vehicle-specific performance suggestions.

Vehicle type	Performance hint
2WD tractor	<p>For an EZ-Steer system installed on tractors that have SuperSteer (for example, New Holland TG). If the tractor has a SuperSteer front axle, for best performance:</p> <ul style="list-style-type: none"> <li>• Reduce the Online Aggressiveness value.</li> <li>• Line up close to the swath and make certain that the front wheels are straight before engaging the EZ-Steer system.</li> <li>• To get smoother performance when the vehicle is pulling an implement over tilled ground, enable the Diff-Lock. This prevents the machine from pulling sharply to the left or right. If you are calibrating on a hard surface, turn off Diff-Lock.</li> </ul>
4WD tractor	<p>The EZ-Steer system can be installed on Case IH STX tractors with Accusteer. For optimal performance, disable Accusteer using the switch in the cab (if possible).</p>
Sprayer	<ul style="list-style-type: none"> <li>• It is common for these vehicles to have slow steering. To compensate for this, use high aggressiveness.</li> <li>• If you experience large, slow oscillations, increase the aggressiveness.</li> <li>• When you configure the system on a sprayer, the Sprayer steering delay setting is available on the <i>Vehicle Setup</i> screen.</li> <li>• Some sprayers have steering that is slow to react after you turn the steering wheel. The system uses the steering delay setting to compensate for this slowness and ensure that steering corrections occur at the correct point.</li> </ul>



Vehicle type	Performance hint
Swather	<ul style="list-style-type: none"> <li>• When you configure the system on a swather, the Swather steering delay setting is available on the Vehicle Setup screen.</li> <li>• Some swathers have steering that is slow to react after the steering wheel is turned. The system uses the steering delay setting to compensate for this slowness and ensure that steering corrections occur at the correct point.</li> <li>• To improve the performance of your swather, adjust the Swather steering delay setting by a small amount (0.1 seconds) at a time. Test the result between each adjustment</li> </ul>

### After using the EZ-Steer system

After you finish using the EZ-Steer system, do the following:

- **Before** you leave the vehicle, turn off the EZ-Steer system power switch or remove the power plug.
- If the EZ-Steer system is not being used, pivot the motor away from the steering wheel.



## The GPS Receiver

- [Configuring the GPS receiver](#)
- [Autoseed fast restart technology](#)
- [Configuring a GPS receiver with the AgRemote software](#)
- [Enabling NMEA message output](#)
- [Enabling radar output](#)

When you install either the Manual Guidance option, the Autopilot option, or the FieldLevel II plugin, the system automatically adds a GPS Receiver option that controls the internal GPS receiver.

In addition, the system may have another GPS receiver. For example, the TrueTracker system uses a second receiver that is configured with a separate GPS Receiver option. This chapter describes how to configure the four versions of the GPS Receiver option.

## Configuring the GPS receiver

1. From the *Configuration* screen, select the GPS Receiver option and then tap **Setup**:

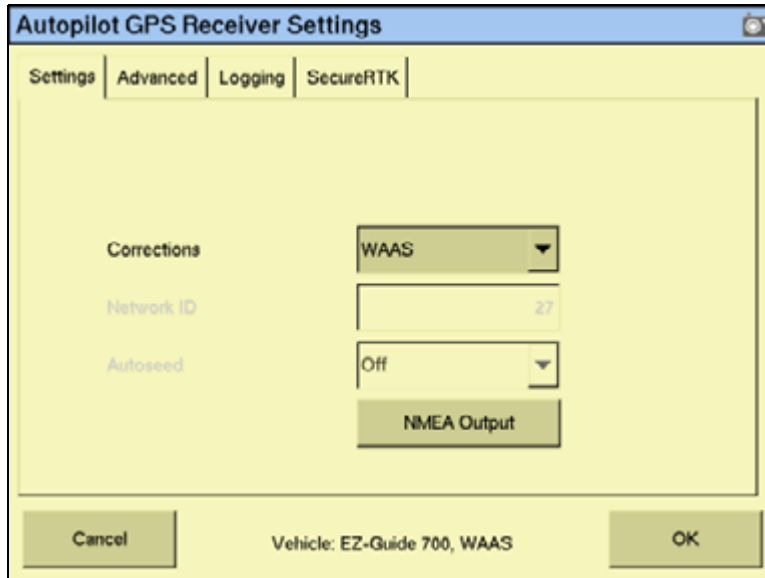

2. In the *Corrections* drop-down list, tap the appropriate corrections to use.
3. If RTK corrections are selected, enter the appropriate base-station network ID.
4. If HP/XP type corrections are selected, the Autoseed™ technology options become available. For more information see [Autoseed fast restart technology, page 175](#).

## Entering 450 MHz frequencies

If your FmX integrated display has a 450 MHz internal radio, you can set the radio frequency and radio wireless modes.

1. From the *Configuration* screen, select the GPS Receiver option and then tap **Setup**:

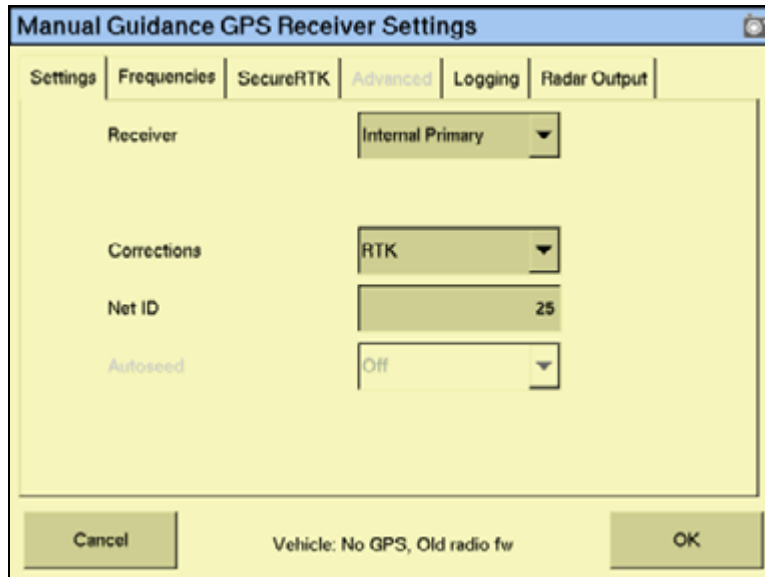

2. Select the *Frequencies* tab. The list of current frequencies appears:

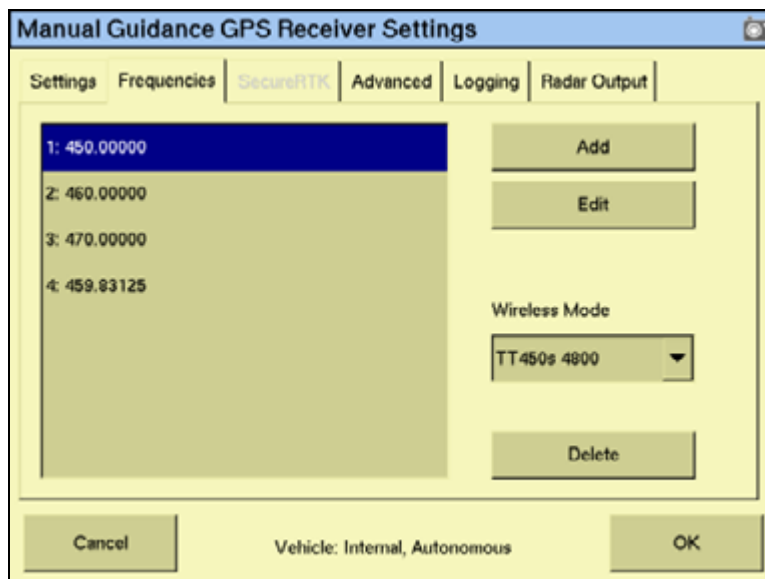

**Note** – Up to 19 different frequencies can be stored.

3. To add a new frequency, tap **Add**.
4. Enter the required frequency for the next available channel and then tap **OK**. The *GPS Receiver Settings* screen appears.
5. From the *Wireless Mode* drop-down list, select the appropriate mode and then tap **OK**.

## Enabling SecureRTK

SecureRTK is a Trimble proprietary base station security feature that enables a Trimble RTK base station service provider to generate time-based access codes for their supported rovers. SecureRTK requires firmware version 1.59, or later, on MS750™ GPS receivers, and firmware version 3.67 on AgRTK and AgGPS 442 base stations.

- From the *Configuration* screen, select the GPS Receiver option and then tap **Setup**:

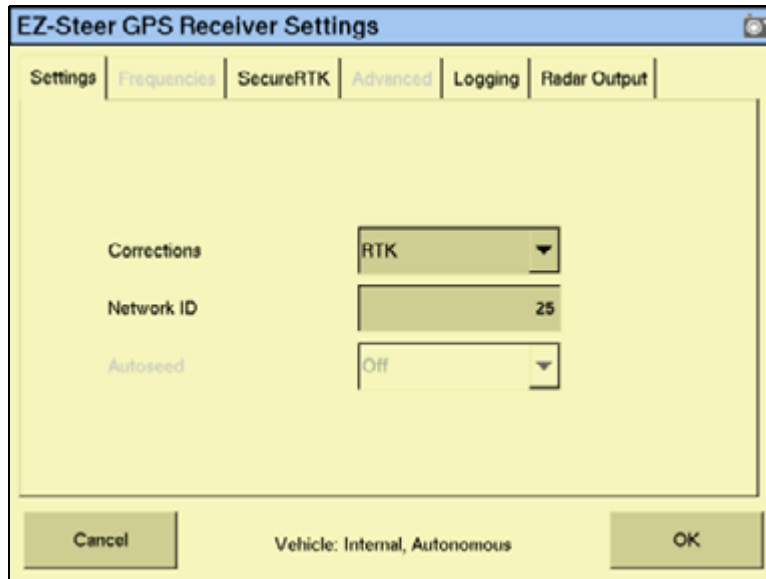

- Select the *SecureRTK* tab.

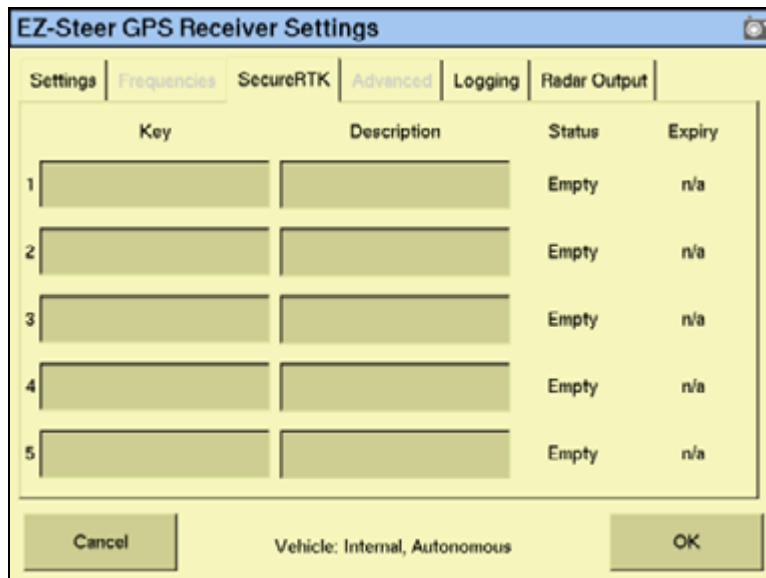

- In the *Key* field, enter the base station access code provided by your base station service provider.

The *Status* and *Expiry* fields change to show the current status of the security feature.

4. **Optional.** In the *Description* field, enter the name of the base station.
5. Tap **OK**.

If SecureRTK is enabled on the base station, rovers with authorized access codes can use corrections from that base.

**Note** – *Rovers without a SecureRTK access code are unable to access a secure Trimble RTK base station.*

## Autoseed fast restart technology

Autoseed fast restart technology greatly reduces the time needed for OmniSTAR HP/XP/VBS convergence. Once the OmniSTAR signal has initially converged, you can turn off the receiver. When you turn the receiver on again, accuracy levels will be similar to those experienced before shutdown.

To benefit from Autoseed technology:

- you must use OmniSTAR HP or XP corrections
- shut down the receiver
- do not move the vehicle before you turn on the receiver again
- the GPS receiver must have a clear view of the sky

**Note** – *Vehicle movement will result in unsatisfactory performance, including longer convergence times and positional offsets.*

To enable the Autoseed technology:

1. On the *Configuration* screen, select the GPS Receiver option and then tap **Setup**. The *GPS Receiver Settings* screen appears.
2. In the *Corrections* drop-down list, select either OmniSTAR HP/XP or OmniSTAR HP/XP-VBS.  
The **Autoseed** button becomes available.
3. Select **Autoseed** and then tap **OK**.

## Configuring a GPS receiver with the AgRemote software

The FmX integrated display has a virtual AgRemote interface for manually adjusting GPS receiver settings. This is recommended for advanced users only.

To access the virtual AgRemote interface:

1. From the *Configuration* screen, select the GPS Receiver option and then tap **Diagnostics**. The *GPS Status* screen appears.
2. Tap **AgRemote**. The virtual AgRemote interface appears.

For more information on the correct use of the AgRemote interface, refer to the *AgRemote Software Guide for AgGPS Receivers* on [www.trimble.com](http://www.trimble.com).

## Enabling NMEA message output

The NMEA message formats are a standard format through which GPS receivers can communicate. If you have an external device connected to the Autopilot controller, you can enable NMEA message output from the controller so that the device receives NMEA GPS positions.

The messages are output through the NavController harness laptop connector.

Some GPS receivers can output NMEA messages to an external device. To do this:

1. On the *Configuration* screen, select the GPS Receiver option and then tap **Setup**. The *GPS Receiver Settings* screen appears.
2. Tap **NMEA Output**:

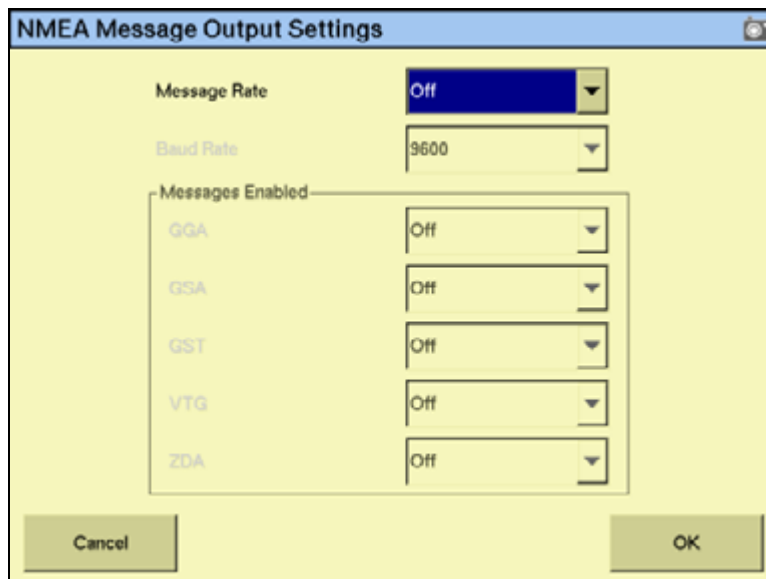

3. Select the appropriate Message Rate and then the Baud Rate.
4. In the *Messages Enabled* group, select the appropriate NMEA message types to output. Do not just enable all formats.



5. Tap **OK** to continue.

**Note** – To enable NMEA output from another receiver (for example, the GPS receiver connected to an TrueTracker system controller), select the plugin for that receiver in the plugin list.

## Enabling radar output

The FmX integrated display can convert GPS speed into an analog frequency that is identical to output from a radar speed sensor. Radar pulses are available from port C or port D of the display.

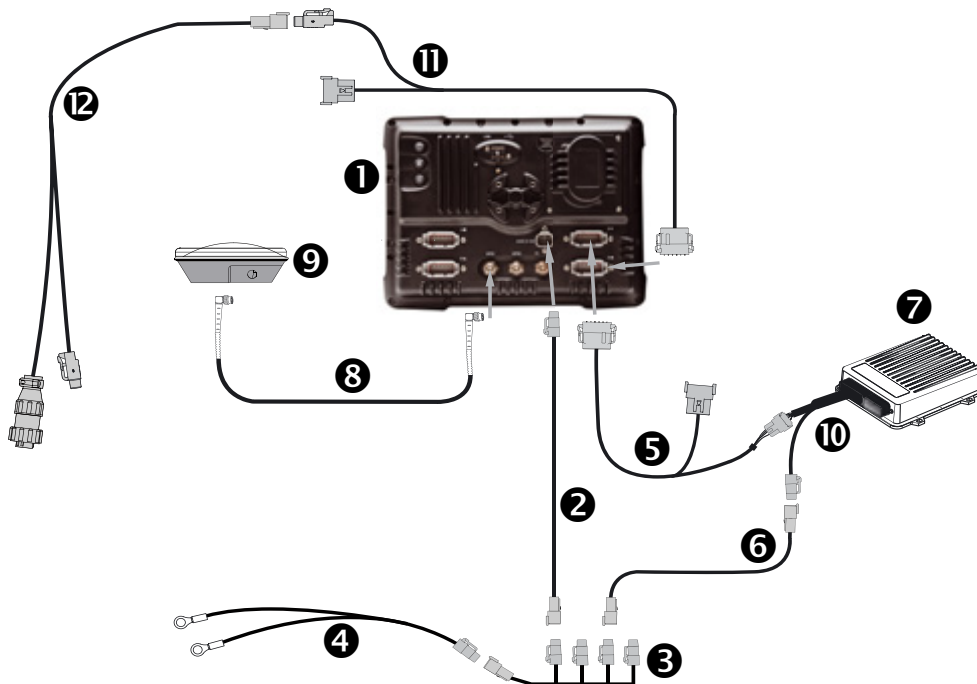

**CAUTION** – Connecting the Port Replicator on the FmX to NavController II cable 5 to the P4 or P12 connector of the NavController II harness 10 will result in damage to the FmX integrated display, and will void the warranty.

Item	Description	Trimble part number
1	FmX integrated display	93100-01
2	FmX power cable	66694
3	FmX power cable with relay and switch (power bus)	67259
4	Basic power cable	67258
5	FmX to NavController II cable with port replicator	75741
6	2 pin DTM to 2 pin DT power adaptor	67095

Item	Description	Trimble part number
⑦	NavController II	55563-00
⑧	8m GPS TNC/TNC RT angle cable	50449
⑨	AG25 GNSS antenna	68040-005
⑩	Main NavController II cable	54601
⑪	FmX universal radar adaptor	68461
⑫	Radar speed output cable	64274

## Configuring radar output

- From the *Configuration* screen, select the GPS receiver for any plugin using an internal GPS receiver and then tap **Setup**:

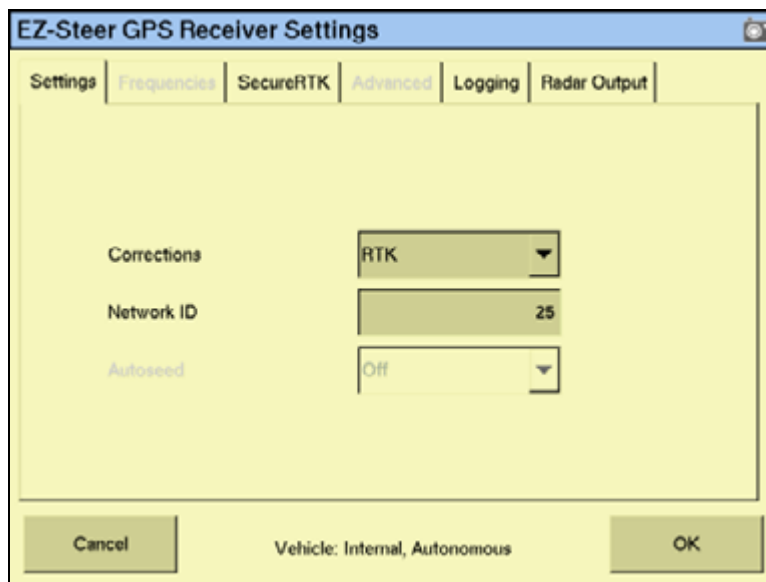

- Select the *Radar Output* tab.

- From the *Connector* drop-down list, select *Connector D* to enable radar output:

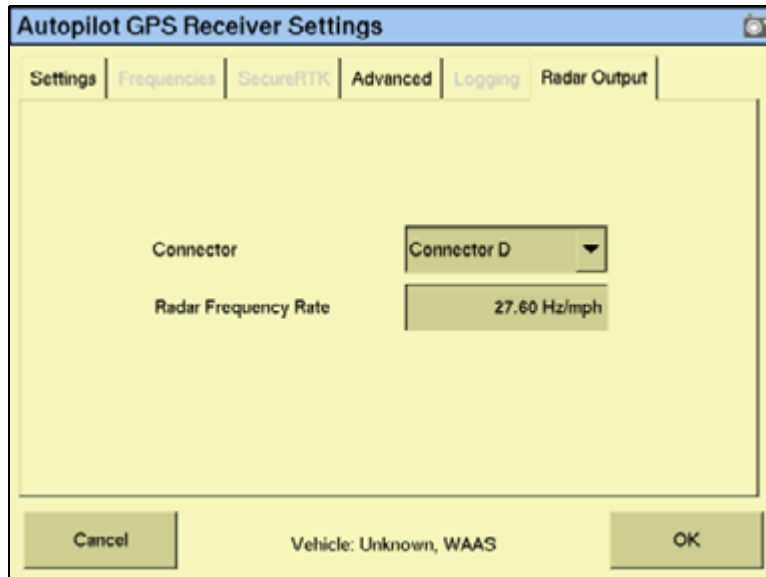

- Select the *Radar Frequency Rate* field.
- Enter the required rate and then tap **OK**. The *GPS Receiver Settings* screen appears.
- Tap **OK**.



# Implement Configuration

## In this chapter:

- Introduction
- Creating an implement
- Selecting an existing implement
- Importing an implement from the FieldManager display
- Adjusting the implement settings
- Deleting an implement

This chapter describes how to configure a vehicle implement. For more information, see [Chapter 22, Advanced Configuration](#).

You must configure your implement so that the system can tell:

- Which type of implement is attached
- How much area it covers
- How far offset it is

***Note** – Some configuration settings are unavailable when a field is open in the Run screen. To access these settings, return to the Run screen and then tap the **Home** button. When prompted to close the field, tap **Yes**.*

## Introduction

To obtain an implement, do one of the following:

- Create a new implement, see below.
- Select an existing implement, see [page 183](#).
- Import an implement that was created for the AgGPS 170 Field Computer, see [page 183](#).

Once you select an implement, adjust its settings. See [page 184](#).

## Creating an implement

1. From the Home screen, tap .
2. In the *Configuration Selection* screen, tap the implement **Switch**.
3. If necessary, enter the Administration password (see [Password access, page 73](#)).
4. In the *Implement Configuration* screen, tap **New**:

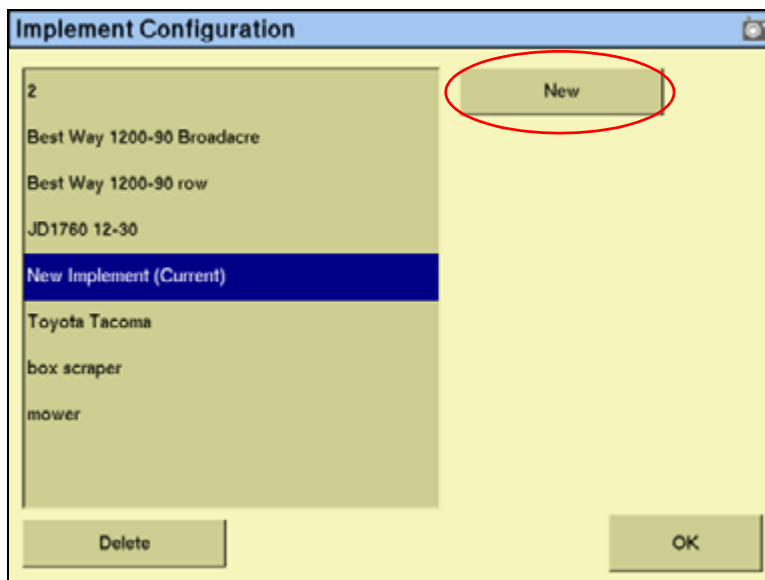

5. The *New Configuration Name* screen (with a virtual keyboard) appears.
6. Enter a name for the new implement and then tap **OK**.  
For more information on configuring the implement, see [Adjusting the implement settings, page 184](#).
7. The *Select Active Plugins* screen appears. Select the plugins that will be used with this implement and then tap **OK**.
8. The *Implement Setup* wizard appears. Enter the appropriate information in each tab, see [Adjusting the implement settings, page 184](#).

**Note** – The required information in the *Implement Setup* wizard varies depending on the plugins that you selected in Step 7.

9. Tap **OK**.

Your current configuration now appears in the *Configuration* screen.

## Selecting an existing implement

To select a pre-configured implement:

1. From the Home screen tap .
2. In the *Configuration Selection* screen, tap the implement **Switch**.
3. If necessary, enter the Administration password. See [Password access, page 73](#).
4. In the *Implement Configuration* screen, select the implement you want to switch to and then tap **OK**.

**Note** – *If there is only one available implement, it is selected by default.*

The currently selected implement is displayed in the *Configuration Selection* screen.

For information on the settings, see [Adjusting the implement settings, page 184](#)

## Importing an implement from the FieldManager display

The FmX integrated display can import and use implements that were created in the FieldManager display.

To import an implement:

1. Copy the implement file into the *AgGPS* folder on the USB memory stick.
2. Insert the memory stick into the FmX integrated display and then turn on the display.
3. From the Home screen, tap .
4. In the *Current Configurations* screen, tap **Configure**.
5. If necessary, enter the Administration password. See [Password access, page 73](#).
6. In the *Configuration* screen, select *System* and then tap **Setup**
7. Select *Data Files* and then tap **Manage**.
8. Select *Implement* from the list on the left of the screen and then tap **Copy**.
9. The implements from the FieldManager display now appear in the *Implement Configuration* screen.

## Adjusting the implement settings

The implement setup screens contains five sections:

Section	Definition
Implement Type	Describes the primary task for the current implement.
Measurements	The basic information required for guidance using the EZ-Steer system, or the Autopilot system.
Geometry	More detailed implement dimensions required for better implement modeling both with and without a GPS receiver on the implement.
Overlap	Values required to apply or avoid overlap.
Extras	Provides access to the <i>Hybrid Setup</i> options and remote log switch configuration.

### Implement Type

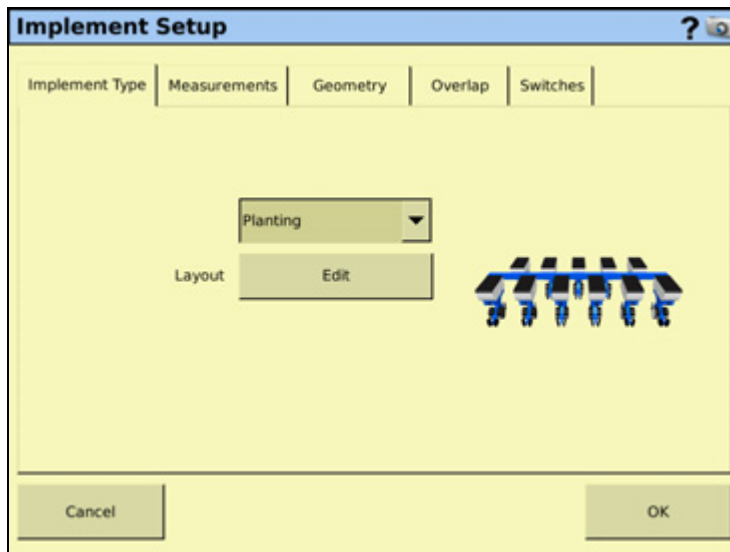

1. In the *Implement Type* tab, select the current task from the drop-down list.
2. To change the implement layout, tap **Edit** and then select the layout type that matches your implement.



## Measurements

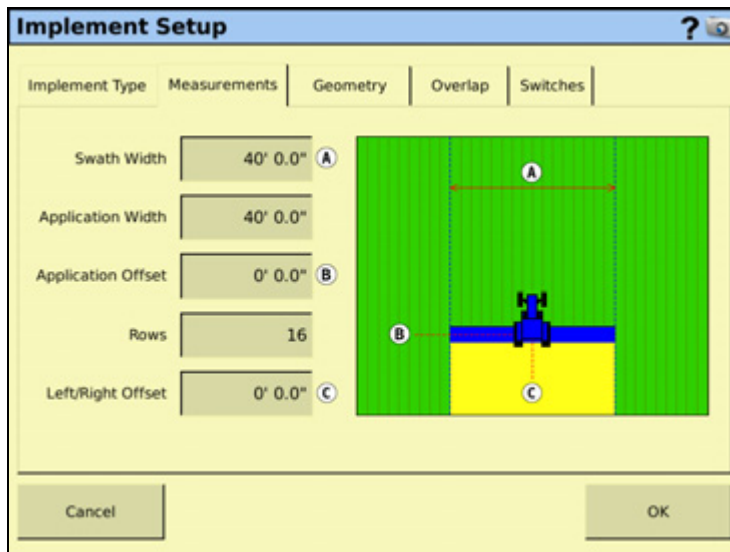

**Note** – The screen is scaled to the swath or application width—whichever is larger. If any offset is greater than this, the tractor image may pass the edge of the screen.

**Note** – This setting is used for navigation; in the Run screen, when you tap **Skip** to adjust the guidance line, the guidance line moves across by this number of rows.

Enter the following implement measurements:

Measurement	Description
Swath Width	Set the distance between guidance passes.
Application Width	The applied width of the tool or boom. This measurement sets the width of the coverage logging and mapping.
Application Offset	Measured from the fixed axle of the vehicle to the point on the implement where coverage logging will be mapped. The fixed axle varies depending on vehicle type: <ul style="list-style-type: none"> <li>• Rear axle on front steering tractor and self-propelled sprayer.</li> <li>• Front axle on a harvester and 4x4 tractor</li> <li>• Center of tracks on a tracked tractor</li> </ul>
Rows	Number of rows that are covered by the implement.
Left/Right Offset	Measured from the center of the vehicle to the center of the implement or header. This measurement adjusts the tractor path so that an offset implement is centered on the guidance line.

## Geometry

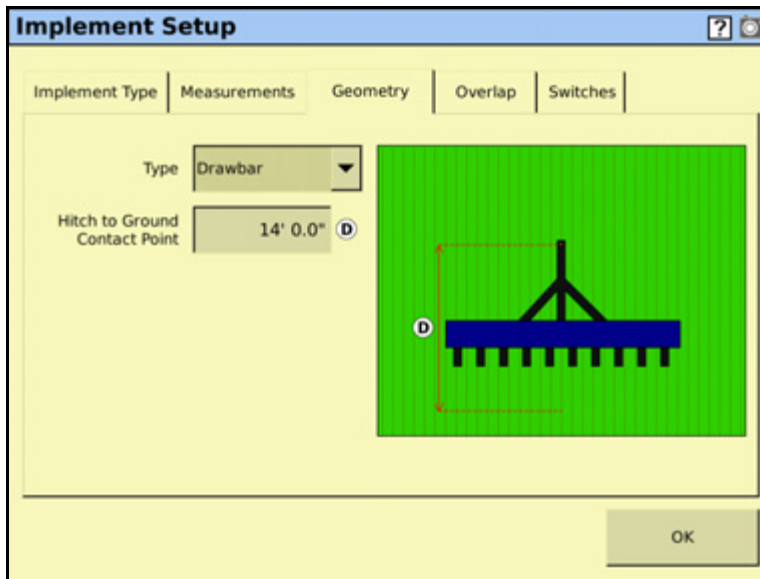

Use the settings on the *Geometry* tab to set up the measurements required for accurate implement modeling.

Measurement	Description
Type	Select the implement type. The antenna offsets are required when a GPS antenna is mounted on the implement for TrueGuide or accurate modeling.
Hitch to Ground Contact Point	Measured from the tractor hitch pin to the soil engagement point that the implement rotates about. For planters this is typically the seeding units or the midpoint of several rows of tools

**Note** – For modeled implements, shortening this setting causes the implement to come online more quickly while lengthening the setting causes the implement to come online more slowly.

## Overlap

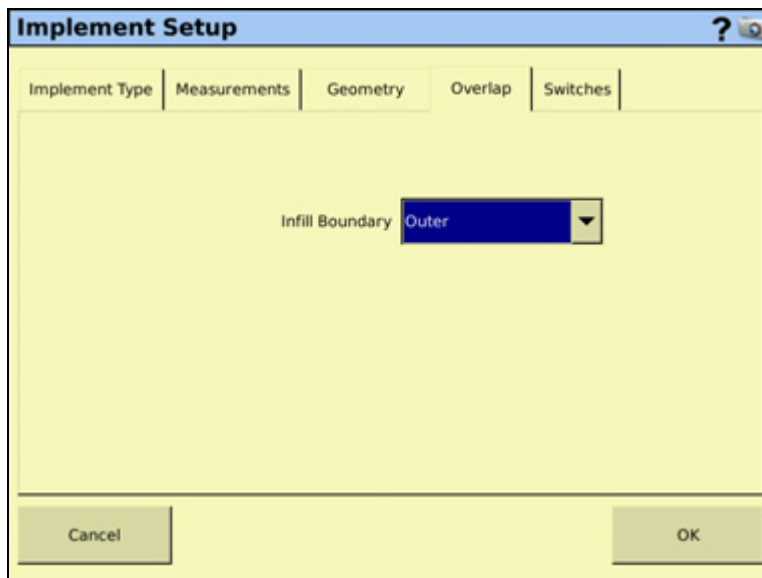

Use this tab to set the *Infill Boundary*. When you map a headland, you create an inner boundary and an outer boundary. Select *Inner* to shut off sections when the implement reaches the inner boundary. Select *Outer* to shut off sections when the implement reaches the outer boundary.

## Switches

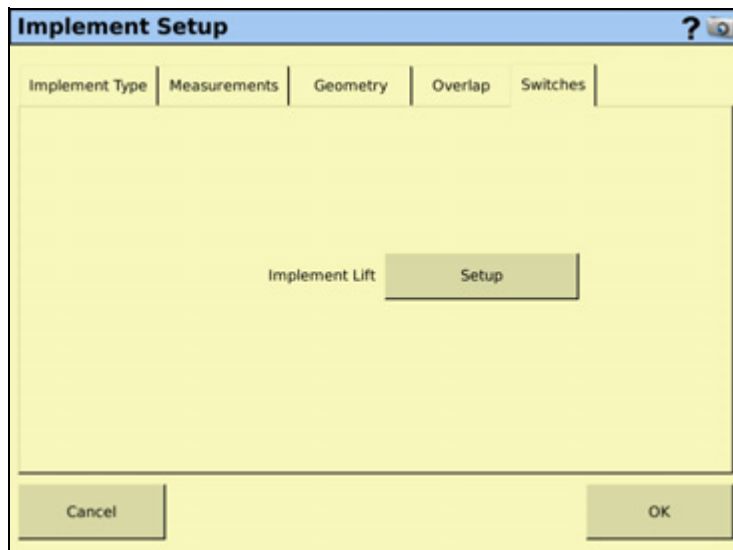

In the *Switches* tab, tap **Setup**:

Set the following in the *Add / Edit Implement Lift Sensor* dialog:

Measurement	Description
Status	Select ON if you have one or more implement switches tied into your implements control system. Select OFF if you have no implement switches tied into your implements control system.
Number of Switches	Select the number of implement switches that you have tied into your implement control system
Minimum Changed Switches	Enter the number of implement switches the system should recognize to determine if the implement is lifted.

## Deleting an implement

To delete an implement that you no longer require:

1. From the *Configuration Selection* screen, tap Implement **Switch**.
2. From the *Implement Configuration* screen, select the appropriate implement from the list.
3. Tap **Delete**.
4. When prompted, tap **Yes** to confirm the deletion.

## Overview of Plugins

### In this chapter:

- Introduction to plugins
- Adding or removing a plugin
- Configuring a plugin
- Entering the password to activate a plugin

This chapter explains the FmX integrated display plugin, and how to configure plugins.

***Note** – Some configuration settings are unavailable when a field is open in the Run screen. To access these settings, return to the Run screen and then tap the Home button. When prompted to close the field, tap **Yes**.*

## Introduction to plugins

The FmX integrated display has a number of plugins that you can install to expand its functionality.

Most of these plugins require additional hardware to work correctly.

Item	Status	Description	See...
Ag3000 modem	Optional	Enable the Ag3000 GSM/GPRS cellular modem to receive RTK type corrections using VRS infrastructure network technology.	<a href="#">Chapter 19, VRS Plugin for DCM-300 and Ag3000 Modems</a>
EZ-Remote joystick	Optional	Control a variety of display functions remotely.	<a href="#">Chapter 20, The EZ-Remote Joystick</a>
LB25 external lightbar	Optional	Monitor your line with a second or third lightbar.	<a href="#">Chapter 21, The LB25 External Lightbar</a>
FieldLevel Survey / Design, FieldLevel II, Tandem/Dual	Optional	<ul style="list-style-type: none"> <li>Survey a field and then create a design.</li> <li>Level the field to a design, install subsurface drainage or surface ditches.</li> <li>Control leveling with two GPS receivers, in one of two possible scraper configurations.</li> </ul>	<a href="#">Chapter 9, Water Management</a>
Field-IQ	Optional	Configure the Field-IQ™ crop input control system to control sections and vary application rates.	<a href="#">Chapter 10, The Field-IQ Plugin</a>
GreenSeeker	Optional	Vary fertilizer rate in real-time using crop vigor measurements.	<a href="#">Chapter 11, The GreenSeeker Plugin</a>
Yield monitoring	Optional	Access yield monitoring information from John Deere combines and Ag Leader displays.	<a href="#">Chapter 18, The Yield Monitoring Plugin</a>
TrueGuide	Optional	Configure the TrueGuide™ implement guidance system for implement control.	<a href="#">Chapter 12, The TrueGuide Plugin</a>
TrueTracker	Optional	Configure the TrueTracker™ system to enable implement steering.	<a href="#">Chapter 13, The TrueTracker Plugin</a>
Serial Rate Controller	Optional	Configure a non-Trimble variable rate controller.	<a href="#">Chapter 14, The Serial Rate Control Plugin</a>
Remote Output	Optional	Enable and configure remote data output to an external device.	<a href="#">Chapter 15, The Remote Output Plugin</a>
Serial Data Input	Optional	Enable and configure data input from an external serial device.	<a href="#">Chapter 16, The Serial Data Input Plugin</a>
Productivity monitoring	Optional	Enable and configure the display to work with an Enalta display to record workflow.	<a href="#">Chapter 17, The Productivity Monitoring Plugin</a>

## Viewing the currently installed plugins

To view the active plugins, do the following:

1. From the Home screen, tap  :

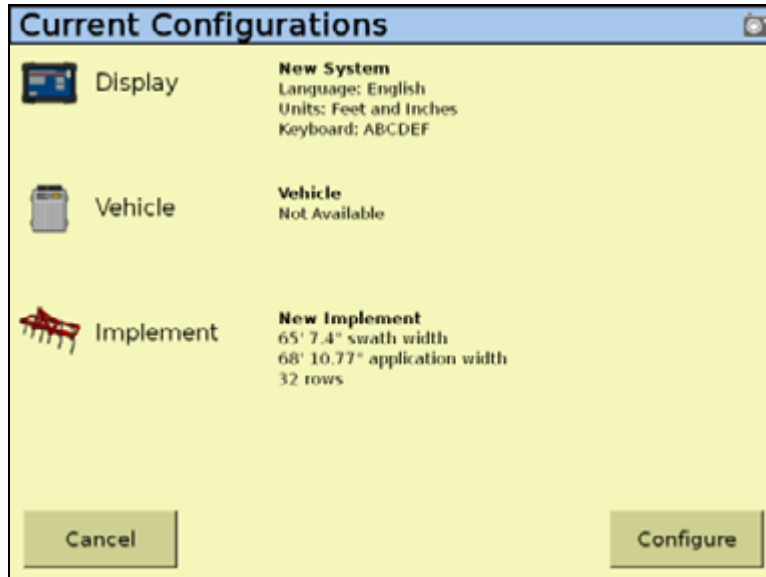

2. From the *Current Configurations* screen, tap **Configure**.

The *Configuration* screen appears, with the currently installed plugins listed on the left of the screen:

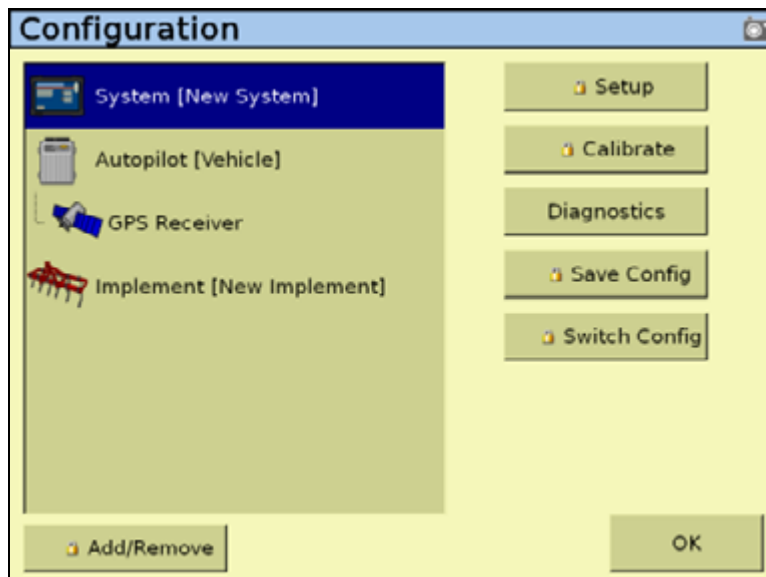

## Adding or removing a plugin

1. On the *Configuration* screen, tap **Add/Remove plugin**:

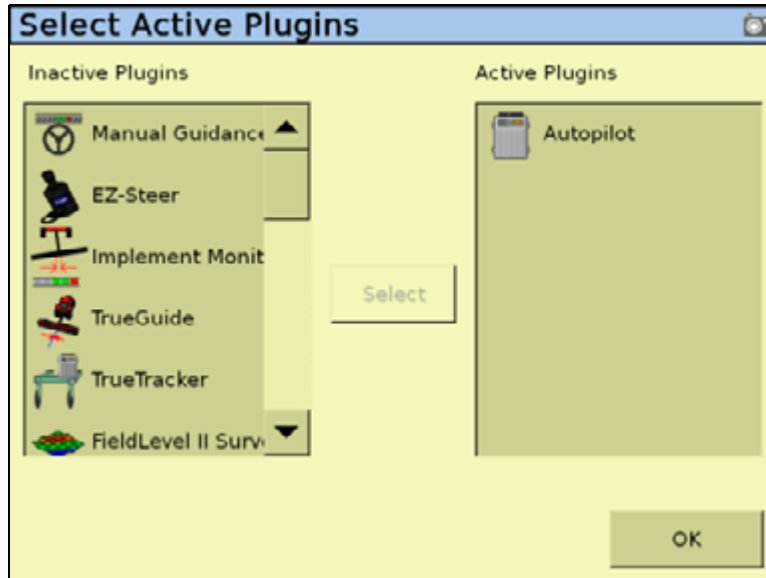

2. If necessary, enter the Administration password (see [Password access, page 73](#)).  
In the *Select Active Plugins* screen, you will see:
  - the available, but not yet installed, plugins are in the *Inactive Plugins* list on the left.
  - the currently installed plugins are in the *Active Plugins* list on the right.
3. Do one of the following:
  - To install a plugin from the *Inactive Plugins* list, tap it and then tap **Add >**. The plugin moves to the *Active Plugins* list.
  - To remove a currently installed plugin from the *Active Plugins* list, tap it and then tap **< Remove**. The plugin moves to the *Inactive Plugins* list.
4. Tap **OK** to return to the *Configuration* screen.



## Configuring a plugin

Each plugin requires a different configuration. For a detailed description of how to configure each one, see the appropriate chapter later in this manual.

In general:

- Each plugin has several setup screens. To access the screens, tap the plugin and then tap **Setup**, **Calibrate**, or **Diagnostics**:

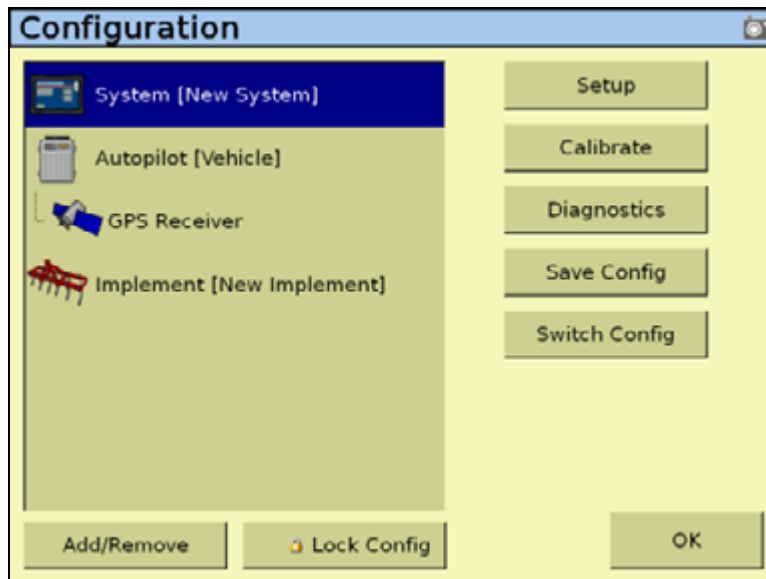

- Most of the plugins add additional features to the main guidance screen.

## Entering the password to activate a plugin

To activate some plugins, you must enter the activation password. If you do not have an activation password, contact your local Trimble reseller.

You can activate a plugin through a text file, see below, or manually, see [page 194](#).

### Option 1. Activating automatically through a text file

*Note – This method of activating the system is faster than the manual method.*

When you purchase the TrueTracker system, the FieldLevel II system, or a variable rate system, your local Trimble reseller provides you with a text file containing a password.

1. Insert the USB memory stick from the FmX integrated display into a card reader that is attached to an office computer.

2. Rename the text file; delete the section of the name following the password number. For example:

**Password 4850576341 FMX 2DGPS to 2GLONASS.TXT**

becomes

**Password 4850576341.TXT**

3. Copy the password text file from the office computer into the `\AgGPS\Firmware\` folder on the memory stick.

When you next insert the USB memory stick in the display and turn on the display, the plugin is automatically activated.

### Option 2. Activating manually through the display

1. Turn on the display and then tap **Unlock** in the Home screen:

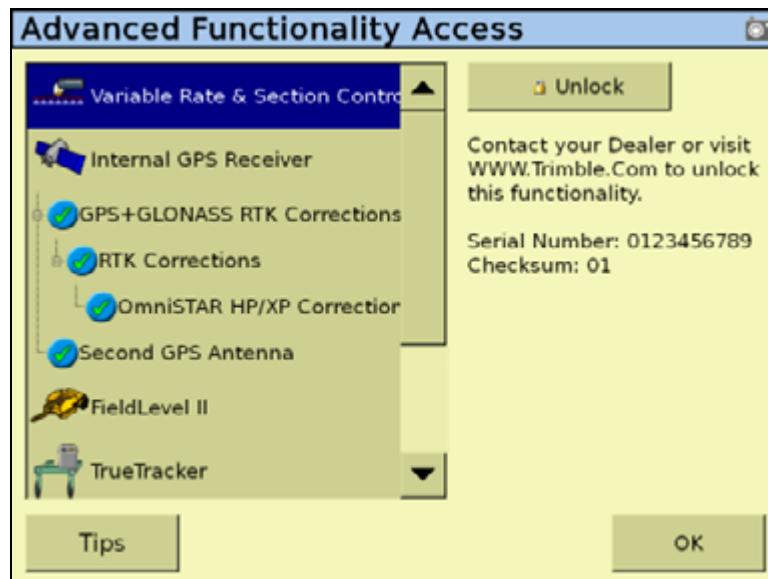

***Note** – The Advanced Functionality Access screen features a **Tips** button that when selected provides more information about the unlock features of the FmX integrated display.*

2. Tap the icon for the plugin that you want to activate and then tap **Unlock**:

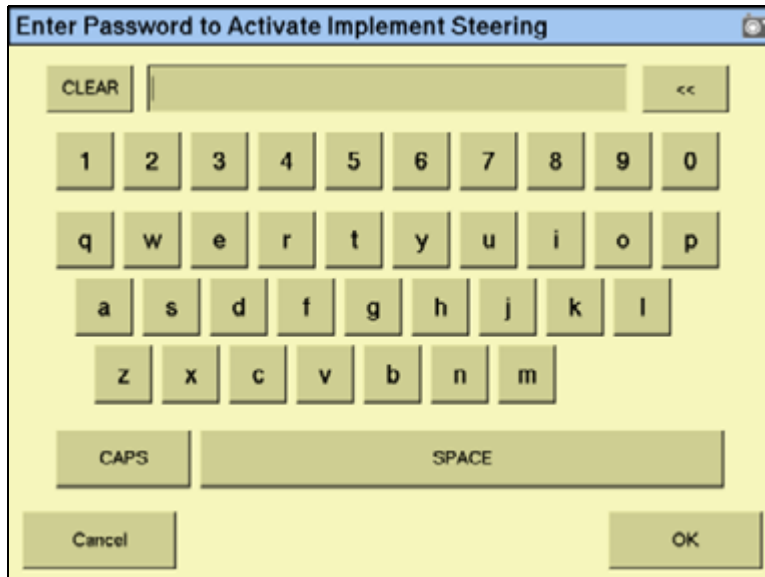

3. In the screen that appears, enter the activation password that your local Trimble reseller provided and then tap **OK**:
  - If you enter a correct password, an **Enabled** message appears. The plugin is now activated.
  - If you enter an invalid password, an error message appears. Enter the password again. If it still does not work, contact your local Trimble reseller.



# Water Management

## In this chapter:

- WM-Survey plugin
- FieldLevel II plugin
- WM-Drain plugin

The FmX integrated display has four Water Management plugins:

- WM-Survey
- FieldLevel II
- Tandem/Dual
- WM-Drain

This chapter describes the function of each plugin, followed by a detailed description of how to configure and use the Water Management plugins to create and manipulate field surveys.

## WM-Survey plugin

Traditionally, farmers level their fields or install tile for uniform drainage. The consistent water flow over the crops improves crop yields and crop consistency, which improves profits.

### Description

The Water Management system is designed in three parts:

- The WM-Survey plugin enables you to use a high-accuracy GPS receiver on the water management implement to create a topographic **survey** of the layout of your field. The three-dimensional data shows the surface topography of the land.

*Note – If you are working in a field that has already been leveled, you may not need to perform a survey and you can go straight to leveling with the FieldLevel II system or installing tile using the WM-Drain plugin.*

Once you complete the survey, you can use it to **design** the optimum drainage slope that can be graded with minimal dirt movement.

- After you create a survey of the field and a design for how to modify it, you can use the FieldLevel II plugin to control a land-leveling implement on your vehicle and to adjust the land to an optimal slope. The FieldLevel II system uses a high-accuracy GPS receiver with an antenna mounted on the implement blade to measure and control its elevation. The FieldLevel II design defines the three-dimensional height for the field and controls how the implement reshapes the ground. The FieldLevel II system automatically raises and lowers the blade on the implement to match the design height anywhere in the field. The color cut/fill map, simple on-screen adjustments, and automatic blade control makes leveling easy.
- For improved productivity when leveling a field, the FieldLevel II system supports tandem or dual scraper implements.

With a tandem system, the second scraper is also controlled by GPS, which means that you can work in areas requiring cuts, and fill two scraper buckets before you have to empty the scrapers.

With a dual system, an antenna on each side of the scraper controls two independent cylinders. This creates a more accurate surface by controlling the height of both ends of the scraper.

### Terminology

A **cut** is a point on the field where dirt needs to be removed. A cut occurs when the existing field is higher than the proposed field surface.

A **fill** is a point on the field where dirt must be added. A fill occurs when the existing field is lower than the proposed field surface.

A **neutral** is a point on the field where the existing and proposed elevations are the same. No dirt needs to be moved at this location.

## Benefits of the Water Management system

The Water Management system enables you to:

- Conserve precious water resources.
- Reduce erosion and conserve topsoil.
- Perform touch-up leveling each year, to avoid expensive land leveling services.
- Help control the water table using WM-Drain drainage features.
- Use RTK GPS technology, which has a significantly larger operating range than a laser, and no vertical limit.
- Work with your existing Agriculture guidance products to manage your fields with one collective system. For example, you can connect the Autopilot system to the FmX integrated display at the same time as the water management implement.
- Manually control the FieldLevel II system with the EZ-Remote joystick or with custom switches controlled by a Signal Input Module (SIM).

## Requirements of the Water Management system

The Water Management system requires:

- An FmX integrated display, with or without the Autopilot system.
- A platform kit to suit your vehicle and valve type (P/N 55045-xx).
- An unlock code for the FmX integrated display water management functionality.
- A leveling or drainage implement.

## Installation

For installation instructions, refer to the *FieldLevel II System Installation Instructions* that are specific to your vehicle.

## Configuration

Install the WM-Survey plugin ( for more information, see [Adding or removing a plugin, page 192](#)). To configure the plugin:

1. From the *Configuration* screen, select the WM-Survey plugin and then tap **Setup**:

2. Set the *Survey Height Offset*. This value represents the difference between the height of the blade when surveying, and the height of the blade when moving dirt. To measure this value, park the implement on a flat surface and raise the blade up to its highest limit and then measure the distance from the bottom of the blade to the surface of the ground. The *Survey Height Offset* will be applied to all surveys to avoid the need to re-bench between *Survey* mode and moving dirt.
3. Set the survey point density from the distance—this can be any value between 5 ft and 100 ft. When you create a survey of a field, this setting determines the distance between the collected survey mapping points.
4. Set the *Cut/fill Color Range*.

The *Cut/fill color range* defines the vertical range in which the colors are spread over the cut/fill map. The cut/fill map appears only after you have surveyed the field and defined a design plane: The range is displayed from the highest cut value to the highest fill value. Example: If your highest cut value is 1 foot and your highest fill value is 1 foot, and you set your *Cut/fill color range* to 2 feet, then the colors will be spread evenly across your cut/fill map. If you change the cut/fill color range to 1 foot then the colors will become more focused around the neutral area, providing more detail closer to the grade.



5. Select the *Relative Heights* tab:

Setting	Value
Relative Heights	Enabled
Relative X	0.00 m
Relative Y	0.00 m
Height Offset	30.48 m
Force Re-bench	No

6. Select *Enabled* from the *Relative Heights* drop-down list.

By default, coordinates are recorded relative to the master benchmark. Setting the relative positions establishes the coordinates of the master benchmark when it is set. These coordinates are then used for field leveling and topographic mapping every time the field is opened. You can set the relative position using these values:

- the X-axis coordinate (Relative X)
  - the Y-axis coordinate (Relative Y)
  - the height (Height Offset)
7. Enter the appropriate offset in each field and then tap **OK** to return to the *Survey Setup* screen.

 **Tip** – To view relative offset values on the Run screen, set the offsets as status text items on the slide-out tab.

8. Select whether or not the system will force you to rebench each time that you reload the field.

**Note** – If you configure the **Force Rebench** setting to **No**, the RTK base station must be placed in **exactly** the same position for the field to be correct.

## Configuring the implement for leveling / drainage

1. From the *Configuration* screen, select Implement and then tap **Setup**:
2. Configure each tab in the *Implement Setup* screen. For more information, see [Adjusting the implement settings, page 184](#).

**Note** – For a multiplane survey, set the *Swath Width* field to the width that you will use for collecting interior points. When you are not using *FieldLevel GPS*, set the *front/back offset (F/B Offset)* to 0. In the *Rows* field, enter 1.

## Operating the WM-Survey plugin

### Run screen

When the WM-Survey plugin is installed, the following tab appears on the main guidance screen (the Run screen):

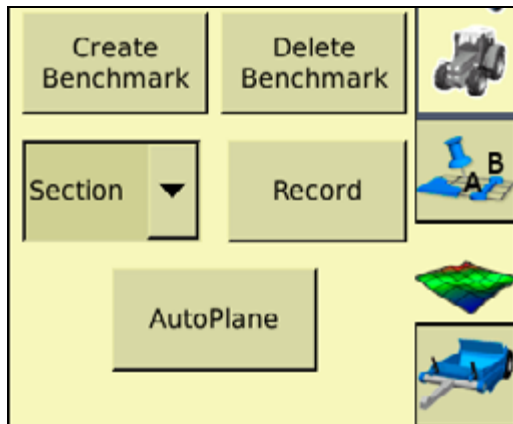

## Creating a survey

### Benchmarks

Before you can create a survey, you must set a **benchmark**—a point at a known location. When you are leveling, you can use benchmarks to do two things:

- Return to a point in the field with known coordinates to re-calibrate your exact position. This may include setting the bucket on the ground or on a solid surface that will not be disturbed while you perform field leveling.
- Move the design up or down to match the field surface at that point.

The first benchmark you create on a field is called the **master benchmark**. Field coordinates are calculated from this point. Subsequent benchmarks are called **benchmarks**. In either plan or perspective view:

- A **master benchmark** appears as an orange flag labeled MB .

- **Benchmarks** appear as orange flags, labeled with their corresponding number .

A master benchmark and several benchmarks shown in plan view:

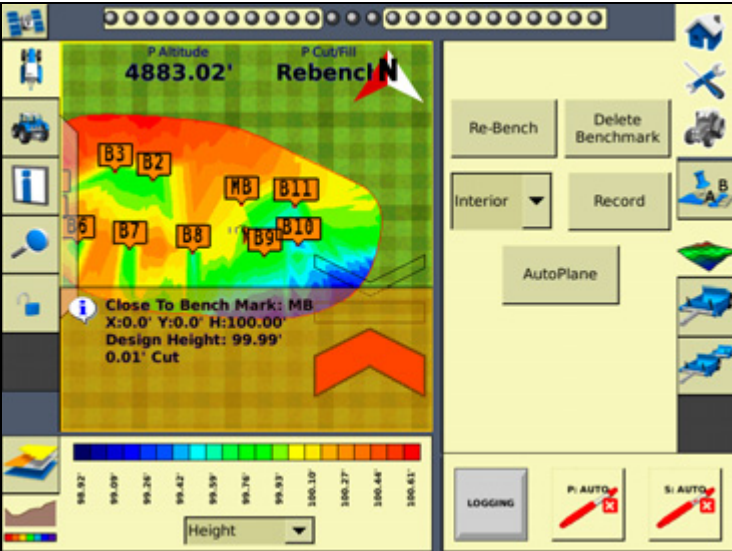

The same master benchmark and benchmarks shown in perspective view:

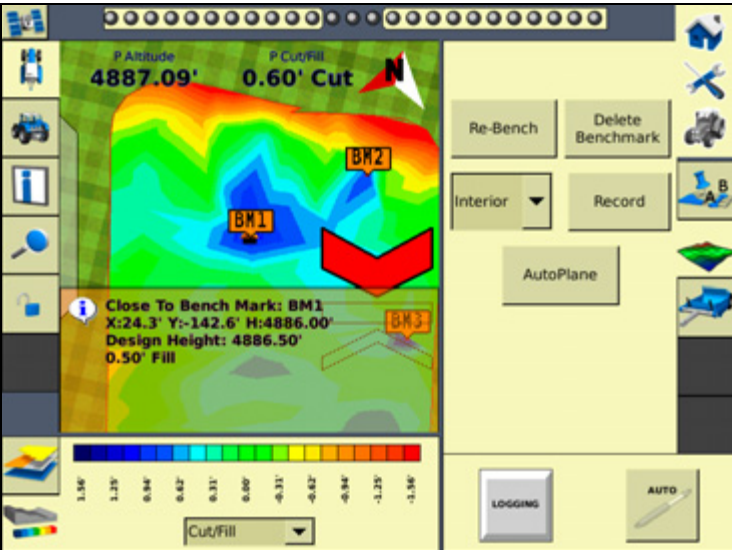

**Note** – You can choose for coordinates to be recorded with X, Y, and Height offsets from the master benchmark position. See [Configuration, page 200](#).

**Note** – You do not need to drive over a benchmark to be able to delete it.

## Creating a benchmark

1. Place the GPS antenna in a known, repeatable location that will not change throughout the leveling of a field.



**Tip** – Mark this location with flags or some other marker so that you can return to the exact spot.

2. Stop the vehicle.
3. Tap **Bench** on the *WM-Survey* tab.

*Note* – If the *FieldLevel II* plugin is installed, you can tap **Bench** on that instead. Both **Bench** buttons have the same effect.

4. A countdown timer runs for 30 seconds and then the system creates the benchmark. To stop the averaging during the countdown, tap **Bench** again.

*Note* – If you are within the circle around an existing benchmark, a new mark is not created.

## Rebenching

When you are within the circle around an existing benchmark, the following message appears on the Run screen:

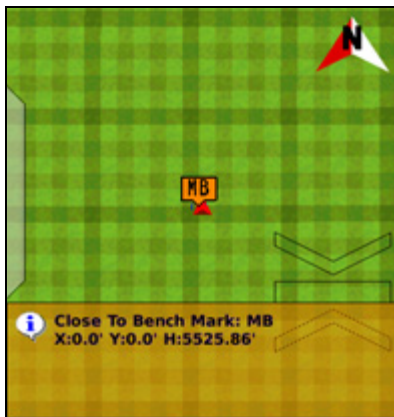

If you tap either of the **Rebench** buttons when the receiver is within the circular radius of a benchmark, the receiver is calibrated over the existing benchmark.

## Re-establishing a benchmark

In the *FieldLevel II* configuration, under the *Relative Heights* tab, there is an option to *Force Re-Bench*. If you plan to use the same base receiver setup each time you use this survey data, you can set the option to *No*.

However, if you plan to shift the location of the base, set this option to *Yes*.

If you open a field that has an existing master benchmark and have selected *Force Rebench*, a large green circle is shown for 100 m (300 ft) around the master benchmark flag:

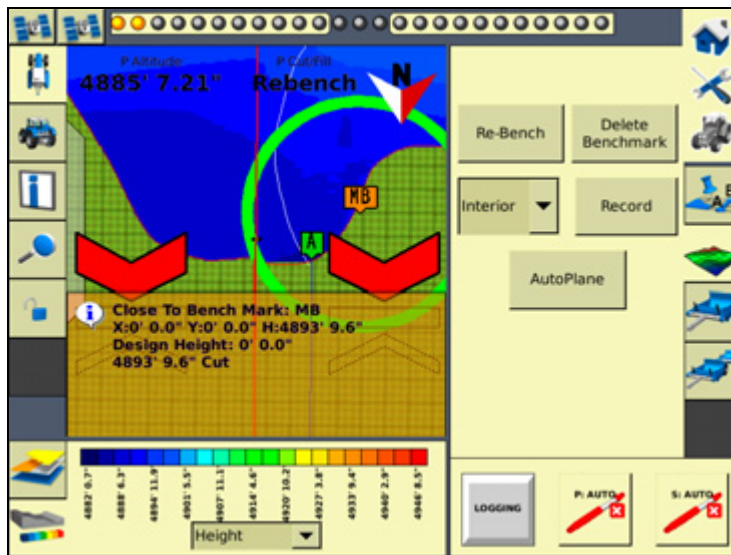

This indicates that you need to rebench over the master benchmark location to ensure that the design is aligned with the previous position.

You must be within this circle before you can re-establish the master benchmark. To ensure that the design is properly aligned:

1. Return exactly to the master benchmark location that you marked on the ground (for example, with flags, see [Creating a benchmark, page 204](#)), regardless of where your current onscreen position appears to be.
2. Re-establish the benchmark.

This process accommodates RTK base station setup differences from the last time the field was open.

### Collecting field data

After you create the benchmark(s), collect field layout data. On the WM-Survey tab that appears on the Run screen (see page 193), use the drop-down menu to select one of the following types of field layout data:

Item	Description
Boundary	The outside of the field
Interior	Points on the inside of the boundary
Section	Can be used to divide the field into smaller sections

To record the layout data, tap **Record**.

To stop recording, tap **Record** again.

### Defining the boundary

Define a boundary to establish the confines of your field. Drive around the boundary while you record the shape.

The boundary is defined on the screen by a single red line. The current position is strung back to the start point of the boundary until you finish recording, so the boundary is always a closed loop.

### Defining interior points

After you survey the boundary of the field, select *Interior* from the list and then tap **Record**. As you drive, the system records interior points.

To complete a full survey, create guidance lines and then drive over all of the interior of the field boundary, while the system records interior points.

### Defining a section

After you define a boundary, you can define sections to split the field into parts. This enables you to create a design for just that section, rather than the whole field.

There are two ways to define a section:

- Begin recording the section line outside the boundary. Drive through the field to define the section line and then cross outside the boundary again. The section is defined.
- Record a section line inside the boundary. The ends of the line will extend to meet the boundary.

Sections can be useful after you finish working on the field for the day. Define the area that you completed as a section; when you return to the field, you can level the remaining area to a second best-fit plane. See [Operating the FieldLevel II plugin, page 219](#).

### Surveying the field

Use the *WM-Survey* tab to survey the topography of the field. You can then choose to create a design plane of best fit to balance the cut and fill values to the preferred ratio.

1. In the *WM-Survey* tab, select *Boundary* from the drop-down list and then tap **Record**.

- 2. Drive the vehicle around the boundary of the field—the boundary is recorded with a line back to the start point. The boundary must be a complete loop.

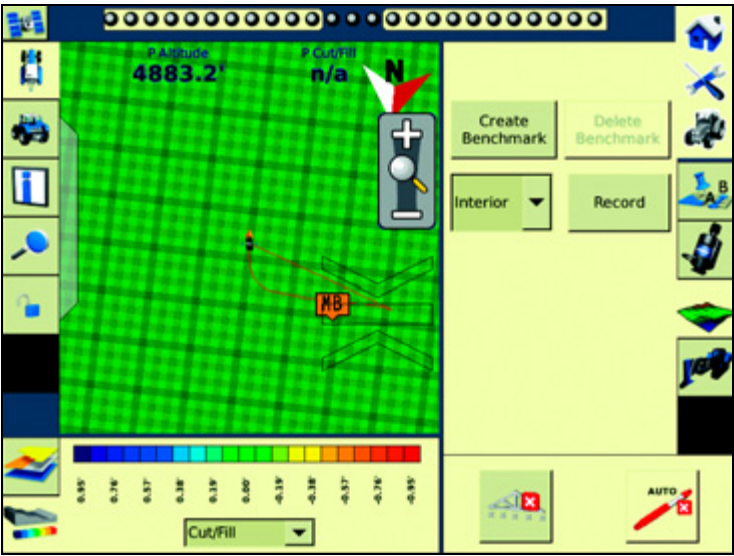

- 3. When you have driven the complete boundary, tap **Record** to stop logging:

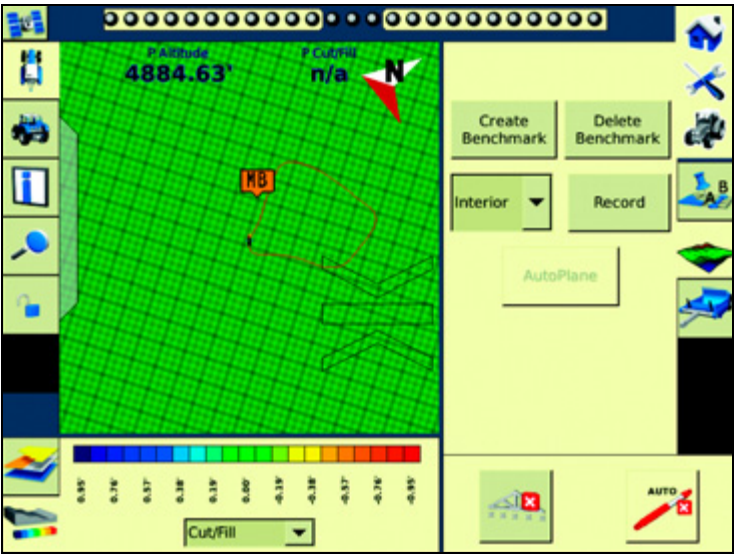



- Change the *Boundary* setting to *Interior* and drive around the interior of the field, gaining enough coverage to produce a height map. You can change the data logging intensity in the FieldLevel II *Survey/Design* settings (Coarse = 25 ft; Medium = 10 ft; Fine = 5 ft):

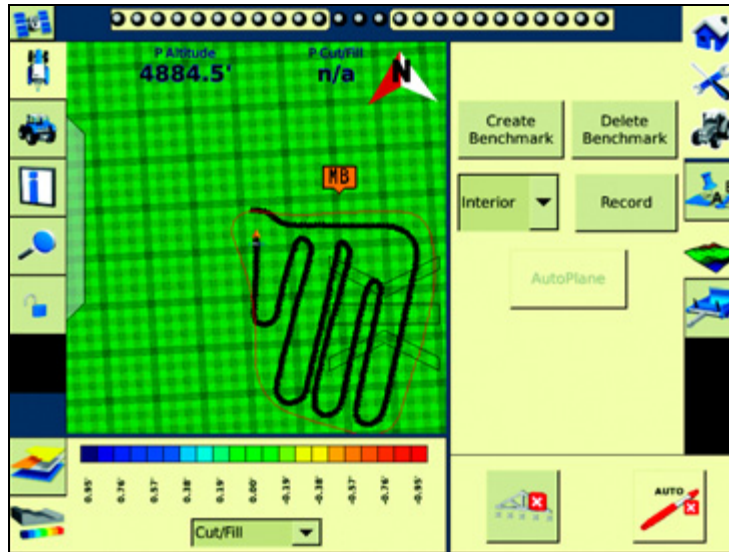

## Field design

Once you have completed the survey, the **AutoPlane** button becomes available.

To create a design for the field, tap the **AutoPlane** button. The field points are processed and then the *AutoPlane* screen appears:

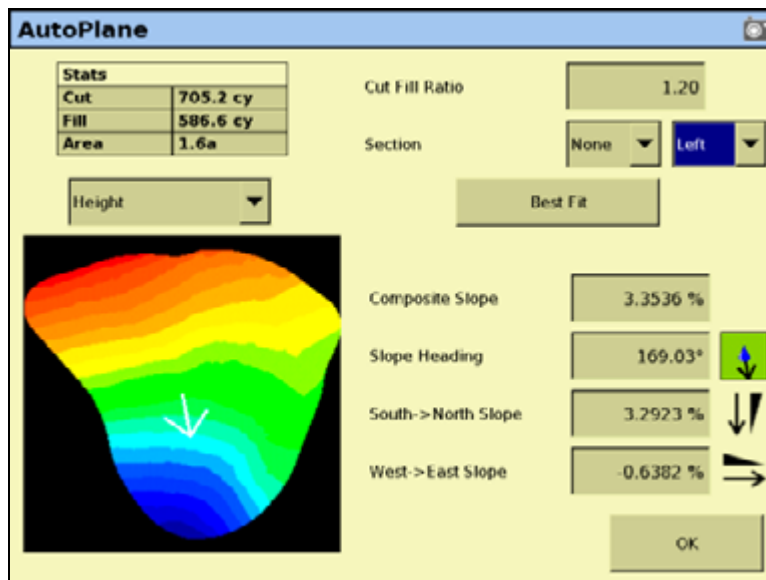

This screen shows field information and enables you to create the design for your field. The AutoPlane functionality uses the topographic survey of your field to estimate the field surface elevations.



Once completed, you can establish a design either by manually editing the slopes or by using the display to calculate a best-fit plane. The best-fit calculation optimizes the height and slopes of a design plane to minimize the amount of dirt that has to be moved.

Once a design is completed, and before you exit the AutoPlane design screen, select the topographic height map or the cut/fill color theme to transfer it to the Run screen with the design.

### Options on the screen

Item	Description
Cut/Fill Ratio	When you move dirt, compaction or expansion can change the volume that it covers. The Cut/Fill Ratio is the amount of cut dirt that equals one volume of fill dirt. For example, the default <i>Cut/Fill Ratio</i> is 1.20. This means you lose 20% of your cut yards to compaction when you put the cut yards back down in the fill areas.
Section	If you set up sections when you defined the field, you can select one from the list.
Left/Right list	The section to the left of the section line, or the section to the right of the section line.

The design slope values show the angles and heading of the slope:

Item	Description
North -> South Slope	The angle of the design slope from North to South.
East -> West Slope	The angle of the design slope from East to West.
Composite Slope	The true angle of fall of the design. This is the angle of the slope when the two angles above are combined.
Slope Heading	The heading direction of the slope, when the two slopes are combined.

The icon beside each slope option shows the direction of the slope:



Because this is a negative slope, it drops from East to West.

The *Stats* table at the top-left of the screen shows field information:

Item	Description
Cut	The volume of dirt that must be cut for the current design.
Fill	The volume of dirt that must be added for the current design. <b>Note</b> – If the <i>Cut</i> and <i>Fill</i> values are the same, you will only be moving dirt. The volumes will balance out. The system includes the Cut/Fill Ratio when configuring these amounts.
Area	The area of the field inside the boundary.

The image of the field on the left of the screen can show one of two things:

- When the **Height** button is selected, the image shows the topographical height of the field:

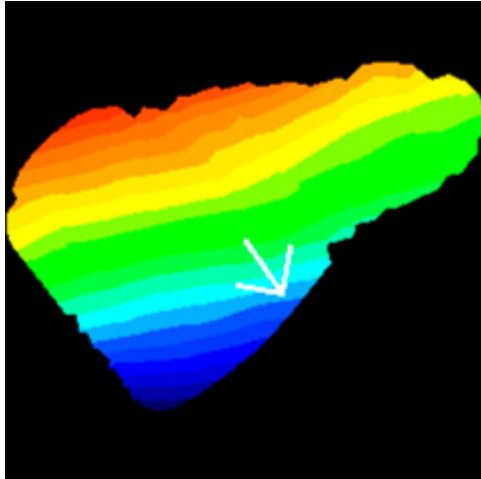

- When the **Cut/Fill** button is selected, the image shows where dirt needs to be removed and where it needs to be added:
  - Areas that require dirt to be cut are shaded red.
  - Areas that require dirt to be filled are shaded blue.
  - Neutral areas that do not need adjusting are shaded green.

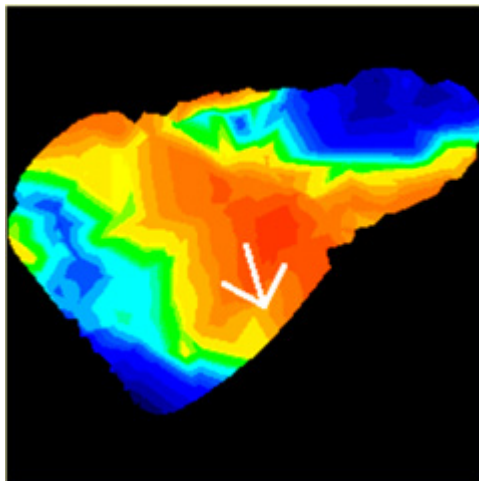

### Creating a design

To create a design for the optimum slope for your field that requires the minimum amount of dirt to be moved:

1. Enter the *Cut/Fill Ratio*.

2. In the *Section* list, do one of the following:
  - Select the section to level.
  - Select *None* to level the whole field.

3. Tap **Best Fit**.

The system uses the interior points that you collected to calculate the optimum slope of the field. The design information appears in the design slope options and the *Stats* table. An arrow appears on the image of the field to show the direction of fall.

If necessary, you can manually adjust the angle of the slope. However, this may require a greater amount of dirt to be moved, because the original design was the optimum.

### Saving the new design

Tap **OK** to close the *AutoPlane* screen. The new design is saved as the default plane for this field. When the field is opened, the design loads but the color theme is not saved. To re-establish the color theme, tap **AutoPlane** and then select **Height** or **Cut/Fill**.

### Reloading a field

When you create a design for a field (for example, a target leveling plane), the design is saved in the */field/* folder.

The design files are associated with the field, so if you close the field and then open it again, the design reloads with the field.

With RTK GPS, the position of the RTK base station is important to the heights used when the field was previously open. If the base station is not accurately positioned in the same physical location, you must reestablish the design over an existing benchmark to reestablish the height.

## FieldLevel II plugin

### Leveling models

In addition to *AutoPlane* and *MultiPlane* design support, the *FieldLevel II* system has five leveling models:

- **Point and Slope** – The system levels at a consistent upward or downward slope, regardless of the vehicle's direction. This can be useful for installing tile and field drainage.
- **MultiPlane** – The *FieldLevel II* system supports external leveling designs from *MultiPlane* design software. This software can run a wide range of “what if” scenarios, enabling you to create complex designs with multiple field sections. You can export these design control files and then load them into the *FieldLevel II* system to shape the field surface based on the work in the office.

- Flat plane (laser) – Use this leveling model to level a field that has previously been measured with a laser. The FieldLevel II GPS system will correct the design heights to a plane surface to match your previous laser system.
- Flat plane (GPS) – Use this model to level a field using the FieldLevel II GPS system. No corrections will be made to a flat plane, so the surface will be curved to match the surface of the Earth. This is the most accurate model to use so that water sits at an equal depth across a field.
- Contour – The system guides you around a contour. The system indicates whether to drive up or down to maintain your current level. This is designed for marking rice levees.

## Terminology

The FieldLevel II system uses the following terms:

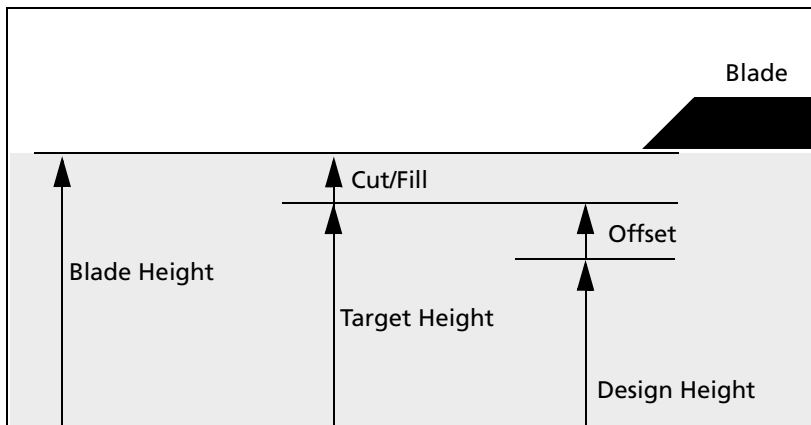

Item	Description
Blade Height	The current height of the blade.
Design Height	The height at the current location determined by the design plane.
Offset	The difference between Design Height and Target Height. Using the offset buttons creates a plane that is parallel to the original design.
Target Height	The height on the target plane that the blade will attempt to reach. This is the Design Height $\pm$ the Offset. When the blade reaches the Target Height, the height indicator arrow turns green.
Cut/Fill	The difference between the Blade Height and the Target Height: <ul style="list-style-type: none"> <li>• When Cut is displayed, the current ground is above the target. The height indicator arrow turns red and points down, which means that the blade needs to move down to reach the Target Height.</li> <li>• When Fill is displayed, the current ground is below the target. The height indicator arrow turns red and points up, which means that the blade needs to move up to reach the Target Height.</li> </ul>

## Configuring the FieldLevel II plugin

**Note** – Before you can configure the system, it must be professionally installed. For more information, contact your local reseller.

There are four steps to complete:

- Step 1. Configuring the implement, page 213
- Step 2. Configuring the leveling model, page 213
- Step 3. Calibrating the FieldLevel II valve module, page 217
- Step 4. Configuring the FieldLevel II GPS receiver, page 218

### Step 1. Configuring the implement

If you have not already configured the implement, see [Configuring the implement for leveling / drainage](#), page 202.

### Step 2. Configuring the leveling model

Install the FieldLevel II plugin ( for more information, see [Adding or removing a plugin](#), page 192).

1. From the *Configuration* screen, select the FieldLevel II plugin and then tap **Setup**:

**FieldLevel II Setup**

Settings | Blade Settings | Relative Heights | Valve Setup | Height Filter

Leveling Model: Flat Plane (GPS)

Allowable Cut/Fill Range: 2' 0.0"

VDOP Level: 3.0

Cancel OK

- Select the leveling model from the drop-down list:



Leveling model	Description
Point and Slope	Creates consistently sloped tile or surface drainage. From the starting point, the vehicle levels at a constant slope, regardless of its direction. See <a href="#">Slope adjust for Point and Slope leveling, page 214</a> .
Flat Plane (laser)	Levels the field to a design plane. The plane can be configured in the onboard software using benchmarks and slopes, or by creating a plane of best-fit over a surveyed surface (Autoslope). It uses a high-accuracy GPS receiver mounted on the leveling implement. However, the design heights are corrected to a plane surface to match your old laser leveled fields. See <a href="#">Configuring settings for all leveling models, page 215</a> .
Flat Plane (GPS)	Levels the field to a design plane. The plane can be configured in the software using benchmarks and slopes, or by creating a plane of best-fit over a surveyed surface (Autoslope). It uses a high-accuracy GPS receiver mounted on the leveling implement. See <a href="#">Configuring settings for all leveling models, page 215</a> .
Multiplane design	Uses more complex surface designs imported from the MultiPlane design software. See <a href="#">Working with MultiPlane designs, page 224</a>
Contour	Uses the FmX integrated display virtual lightbar, or an LB25 external lightbar to guide the vehicle along contours to keep the vehicle at the same elevation. This can be used for levee marking and applications that require guidance to elevations. See <a href="#">Configuring settings for all leveling models, page 215</a> .

The FieldLevel II plugin *Setup* screen has five tabs: *Settings*, *Blade Settings*, *Relative Heights*, *Valve Setup*, and *Height filter*.

The *Settings* tab is the same for all leveling models, except for Point and Slope, which includes an extra field for *Slope Adjust*. The other four tabs are the same regardless of which leveling model you choose, and are described in the following sections.

### Slope adjust for Point and Slope leveling

When you select Point and Slope leveling, the *Slope Adjust* setting appears in the first settings tab of the FieldLevel II *Setup* screen.

Item	Description
Slope Adjust	The <i>Slope Adjust</i> field controls the amount that the gradient changes each time you tap the up arrow  or the down arrow  on the <i>Level</i> tab. For example, if the leveling gradient is set to -3%, and the <i>Slope Adjust</i> field is set to 2%, when you tap the down arrow  on the <i>Level</i> tab, the leveling gradient increases to -5%.

## Configuring settings for all leveling models

Item	Description
Allowable Cut/Fill Range	Select the <i>Allowable Cut/Fill Range</i> field and then enter the acceptable warning distance. When Auto mode is engaged and the blade is outside this range for more than three seconds, a warning appears.
VDOP Level	<i>Vertical Dilution of Precision</i> (VDOP) is a measure of the vertical accuracy of the GPS signal. If the VDOP reaches this value, a warning message appears. A VDOP setting of less than 3 is recommended.
Blade Step	Tap the <i>Blade Step</i> field and then enter the amount that you require the blade to move, each time it is "stepped" up or down by the <b>^</b> or <b>v</b> offset buttons.
Course Blade Step	Coarse mode enables you to offset the target height in large increments with a single tap, such as a 0.2' fill. Select the <i>Coarse Blade Step</i> field and then enter the amount that you require the blade to move each time it is stepped up or down in <i>Coarse</i> mode.
Antenna Height	Select the <i>Antenna Height</i> field and then enter the height of the antenna above the lower edge of the blade.
On-grade Limit	Select the <i>On-grade Limit</i> field and then enter the limit. This sets the distance the blade can move before the green blade height indicators change to thin red arrows. At twice this distance, the height indicators become thick red arrows. See <a href="#">Blade position indicators</a> , page 220.
Disengage Raise	When you disable <i>Auto</i> while scraping a field, you can set a time value that will automatically raise the blade. For example, if you set 0.5s, the blade will raise for half a second when you turn off <i>Auto</i> mode.
Remote Input Auto	You can attach a remote for enabling and disabling <i>Auto</i> mode. This remote is controlled with the <i>Remote Input Auto</i> setting.

## Configuring relative heights for all leveling models

By default, relative heights are enabled (meaning coordinates are recorded relative to the master benchmark). For field leveling or data collection, you can set relative offsets so that the coordinates are recorded relative to the offsets set for the master benchmark. You can set offsets in any of the following directions:

- The X-axis
- The Y-axis
- The height

The *Relative Heights* tab of the *FieldLevel II Setup* screen shows the following items:

Item	Description
Relative Heights	Select <i>Enabled</i> to use relative heights from the master benchmark. Choose <i>Disabled</i> to use GPS heights at all times.
Relative X	If relative heights are enabled, this is the X coordinate that will be applied to the master benchmark.
Relative Y	If relative heights are enabled, this is the Y coordinate that will be applied to the master benchmark.

Item	Description
Height Offset	If relative heights are enabled, this is the height value that will be applied to the master benchmark.
Force Rebench	If Force Rebench is set to Yes, and the field has been closed and opened again, the system will not let you start work until you have re-benched. Use this setting if you are using a different base station setup between work sessions. If you have a permanent base station setup that is never moved, then it is OK to not force a rebench.



**Tip** – To view relative offset values on the Run screen, set the offsets as status text items on the slide-out tab.

### Configuring the Valve Setup for all leveling models

When you select the *Valve Setup* tab on the FieldLevel II *Setup* screen, the following items are available:

Item	Description
Valve Type	Select the <i>Valve Type</i> field and then select the type of valve that is connected.
CAN Bus	Select the port on the FmX integrated display that the valve module is connected to.
Valve inverted	Leave this field as Not Inverted unless the tank and pressure hoses have been installed incorrectly on the valve. If this is the case, select Inverted to eliminate the need to reverse the hoses.

### Configuring the Height Filter for all leveling models

When you select the *Height Filter* tab on the FieldLevel II *Setup* screen, the following items are available in the *Filter Type* list:

Item	Description
None	This setting (this is the raw GPS data used for height) is recommended.
Average	The height will be averaged using the number of positions selected. This will smooth spikes in height readings but will introduce a latency into the controls.
Jump detect	This will filter out some jumps in the height readings. When selected, the following values must be entered: <i>Threshold</i> = the change in height value that will trigger the filter. <i>Decay Time</i> = once the filter is triggered, this will be the amount of time it takes to gradually resume using the raw GPS height.



### Step 3. Calibrating the FieldLevel II valve module

*Note* – Depending on the make and manufacturer of your vehicle, the tractor computer may need to be put into a special mode. Refer to the *FieldLevel II Installation Guide* for your vehicle type.

1. From the *Configuration* screen, select the FieldLevel II plugin and then tap **Calibrate**:

2. Set the vehicle throttle to 100%.
3. Tap **Start**.

The system performs its calibration sequence to test the speed at which the blade raises and lowers. This process takes approximately 8 – 10 minutes.

To manually calibrate the valve, enter values in the three *Manual Calibration* fields and then tap **OK**.

### Step 4. Configuring the FieldLevel II GPS receiver

The FieldLevel II system uses its own GPS receiver to record the exact position of the leveling blade. To configure this receiver:

1. From the *Configuration* screen, select the GPS Receiver option that is associated with the FieldLevel II plugin and then tap **Setup**:

2. From the *Receiver* drop-down list, select which GPS receiver you will use for your FieldLevel system. It is recommended that you select *Internal Primary* when configuring the display as a stand-alone FieldLevel II system, but you can use an external GPS receiver. If you are also using the Autopilot system, it is recommended that you use *Internal Secondary*, as the Autopilot system will be occupying the Internal Primary receiver.
3. From the *Corrections* drop-down list, select *RTK* for all FieldLevel II applications.
4. Set the *Network ID* to the same network ID that is set in the base station receiver
5. Tap **OK**.

The FieldLevel II plugin is now configured and ready to use.

## Operating the FieldLevel II plugin

### Run screen

The FmX integrated display's Run screen changes when the FieldLevel II plugin is installed. It can also change depending which leveling model is selected:

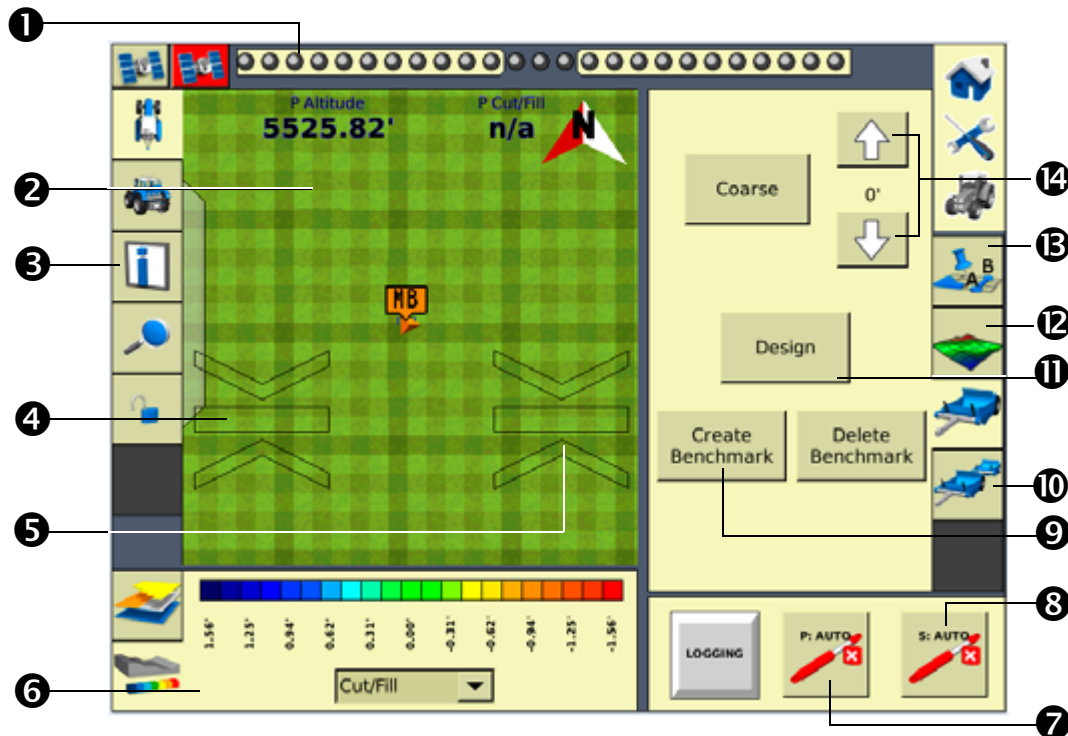



Item	Description	Description
①	Virtual lightbar	Provides guidance with illuminated LEDs. When using the FieldLevel II Contour leveling model, the virtual lightbar can be used for levee marking. Also, in the Autoslope leveling model, it will guide you onto the design alignment when installing tile or cleaning a surface ditch.
②	Cut/fill map	Shows the difference between the design plane and the survey. Green areas are on grade, blue areas require fill, and the red areas require cut.
③	Status items tab	Open to view a variety of text information regarding the operation of the FmX integrated display.
④	Primary cut/fill indicator	Primary cut/fill indicator. When the blade is below grade, the up arrow is red (thin is close, thick is a long way off). When the blade is above grade and cut is required, the down arrow is red. When on grade, the center is green. See <a href="#">Blade position indicators, page 220</a> .
⑤	Secondary cut/fill indicator	For use with tandem and dual scrapers. For dual scrapers it is the right side. For tandems, it is the rear scraper. See <a href="#">Blade position indicators, page 220</a> .
⑥	Cut/fill status panel	This scale bar displays the number value assigned to each color. You can choose to display either cut/fill or height.



Item	Description	Description
7	Primary Auto	This button engages the automatics to the hydraulic valve controlling the blade. When using dual scrapers, this is the left side of the blade. When using tandem scrapers, this is the front scraper.
8	Secondary Auto	This button engages the automatics to the hydraulic valve when using dual or tandem scrapers. When using dual scrapers, this is the right side of the blade. When using tandem scrapers, this will control the rear scraper.
9	Create Benchmark	You must create benchmarks that FieldLevel II operations use as a point of horizontal and vertical reference.
10	FieldLevel II dual control	Used for either a dual or tandem scraper configuration.
11	Design button	Engage this button to design a field slope and orientation, or in the case of Autoslope, you can set the design parameters for the tile or surface ditch profile.
12	WM-Survey control	Used for surveying boundaries, interior lines, or section lines. It is also for designing an "Autoplane" surface where you can create a best-fit plane through a surveyed field and balance the cut and fill to your requirements.
13	FieldLevel II single control	Used when there is a single antenna on a scraper or tile plow.
14	Blade step	Use the up and down arrows to manually adjust the grade of the scraper or tile plow blade.

### Blade position indicators

When you use the FmX integrated display to provide guidance (for example, guiding to a contour), guidance is displayed on the virtual lightbar at the top of the screen.

When you use the display to show field leveling information, blade position indicators appear on the Run screen.

Item	Description	Example
Green bar in center	The blade is at the correct target height (it is within the <i>On-Grade Limit</i> ).	
Small red arrow pointing up	The blade is beyond the <i>On-Grade Limit</i> value below the target height.	
Large red arrow pointing up	The blade is considerably below the target height (more than double the <i>On-Grade Limit</i> value).	

Item	Description	Example
Small red arrow pointing down	The blade is beyond the <i>On-Grade Limit</i> value above the target height.	
Large red arrow pointing down	The blade is considerably above the target height (more than double the <i>On-Grade Limit</i> value).	

The arrow points in the direction that the blade needs to move for the blade to be on grade. The size of the up or down arrow indicates the amount of movement required.

### FieldLevel II status text items

Status text items describe factors in leveling models.

*Note* – The *FieldLevel II* status items all begin with *P* which denotes the *Primary GPS receiver*. If you have the *Tandem/Dual plugin* installed, you will also have *"S"* status items available which denotes *Secondary*.

Item	Description
P Altitude	The current GPS altitude of the blade.
P Blade Height	The current height of the blade shown as a relative height or a GPS height depending on settings selected.
P Boot Depth	The depth of the boot when installing tiles or the depth of the blade when cleaning surface ditches (used with the Autoslope leveling model).
P CMR Percent	The percentage of data being successfully received from the base GPS receiver.
P Correction Age	The time since the last GPS correction was received from the GPS base station.
P Correction Type	The solution type (for example: RTK Fixed, or RTK Float, etc.)
P Cut/fill	The difference between the blade height and the target height. When <i>Cut</i> is displayed, the current ground height is above the target height, and the height adjustment indicator shows a red down arrow, which means that the blade needs to moved down to reach the target height. When <i>Fill</i> is displayed, the current ground height is below the target height.
P Design Height	The originally planned or designed height at the current location.
P Design Slope	When using the Autoslope leveling model, this displays the design slope with respect to the current location along the section line.
P Distance Travelled	For use with Point to Slope mode, this is the distance traveled since Auto mode was enabled.
P East	The difference in the East component from the <i>Local Tangent Plane</i> (LTP).
P GPS Status	The solution type (for example: RTK Fixed, or RTK Float, and so on).
P H Error	The current estimate of the error in the horizontal component.
P HDOP	The horizontal dilution of position.
P Heading	The current direction that the vehicle is heading in.
P Latitude	The latitude as recorded by the GPS receiver.
P Longitude	The longitude as recorded by the GPS receiver.

Item	Description
P Network ID	The network ID that the GPS receiver is set to, which needs to be the same as the base receiver network ID.
P North	The difference in the North component from the <i>Local Tangent Plane</i> (LTP).
P Offset	The relative offset in the vertical component.
P Offset X	The relative offset in the X component.
P Offset Y	The relative offset in the Y component.
P Satellites	The number of satellites in the GPS/GLONASS solution.
P Section Line Number	The line number selected for design in AutoSlope. This is the current section line being recorded in the field.
P Speed	The current speed of the vehicle.
P Survey Cut / Fill	The cut/fill for the location of the vehicle within a field that has been processed in AutoPlane.
P Target Height	The height the blade will attempt to reach. This is the design height $\pm$ the offset. When the blade reaches the target height, the arrows turn green.
P Up	The difference in the up component from the Local Tangent Plane (LTP).
P VDOP	The vertical dilution of precision.
P Vertical Error Estimate	The current estimate of error in the height calculated by the FieldLevel GPS receiver.

These status text items can be set to appear permanently at the top of the screen or on a slide-out tab. The following items can also be viewed from the Run screen:

- FieldLevel GPS status
- FieldLevel Number of satellites
- FieldLevel correction age
- To configure the status items, see [Status items, page 77](#).

### Reloading a field

When you create a design for a field (for example, a target leveling plane), the design is saved in the */field/* directory.

The design files are associated with the field, so if you close the field and then open it again, the design reloads with the field.

With RTK GPS, the position of the RTK base station is important to the heights used when the field was previously open. If the base station is not accurately positioned in the same physical location, you must reestablish the design over an existing benchmark to reestablish the height.

## Re-establishing a benchmark

If you open a field that has an existing master benchmark, a large green circle is shown for 100 m (300 ft) around the master benchmark flag:

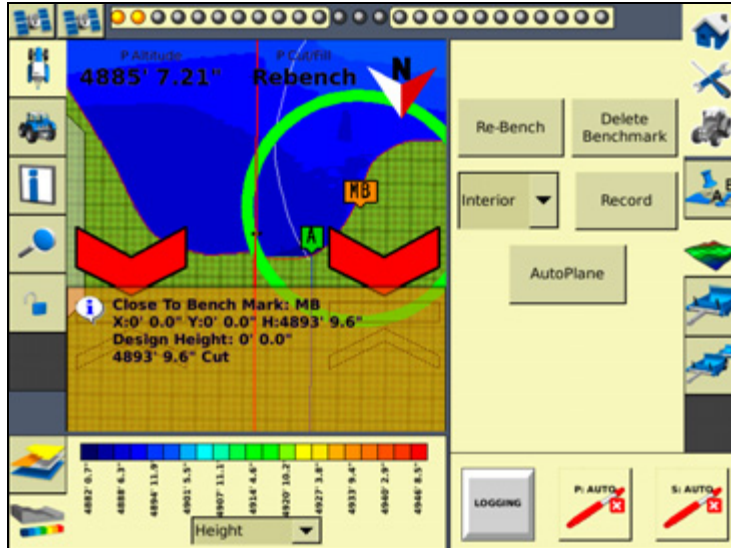

This indicates that you need to rebench over the master benchmark location to ensure that the design is aligned with the previous position.

You must be within this circle before you are allowed to re-establish the master benchmark. To ensure that the design is properly aligned:

1. Return exactly to the master benchmark location that you marked on the ground (for example, with flags, see [Benchmarks, page 202](#)), regardless of where your current on-screen position appears to be.
2. Re-establish the benchmark.

This process is designed to accommodate RTK base station setup differences from the last time the field was open.

## Importing control files from the Multiplane software

Once you finish manipulating a topographic survey file in *MultiPlane*, you can export a control file (\*.GPS) for use with the FieldLevel II system. Copy the design control file into the `\AgGPS\Designs\` folder on a USB memory stick.

If the USB memory stick has not yet been used with the FmX integrated display, the `\AgGPS\Designs` folder will not exist. To create the directory on the USB memory stick:

1. Insert the USB memory stick into the back of the FmX integrated display.

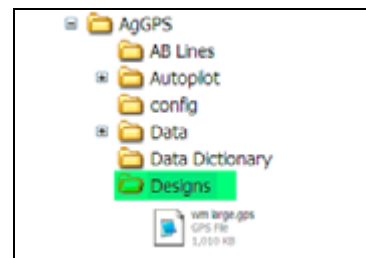

2. From the *Configuration* screen, select *System* and then tap **Setup**. The *System Setup* screen appears.
3. From the list of system settings on the left, select *Data Files* and then tap **Manage**. The *Data Files* management screen appears.
4. From the list on the right (directories that already exist in the display), select the *Designs* directory and then tap **Copy**. The directory is copied to the USB memory stick.
5. When the **Copy completed** message appears, tap **OK**. The copied directory appears in the list of directories on the left side of the *Data Files* screen.

## Working with MultiPlane designs

When the leveling model is set to *Multiplane Design* and the FmX integrated display opens a field, it scans the `\AgGPS\Designs\` folder and any MultiPlane .gps control files that are close to your current position are displayed:

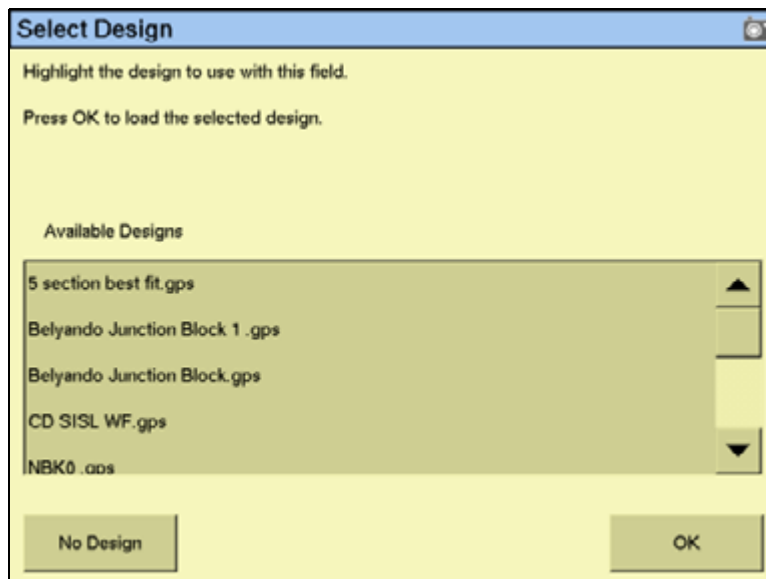

Select the appropriate control file and then tap **OK**.

The control file will be loaded, displaying a color cut/fill map of the field (red = cut; blue = fill).



When you use a MultiPlane design control file, the FieldLevel II system remains in Auto mode if you drive off the design, but maintains the design height it had when you left the design. If you disengage Auto mode when you are off the design, the display will not allow you to re-engage the FieldLevel II system until your position is back over the color cut/fill map.

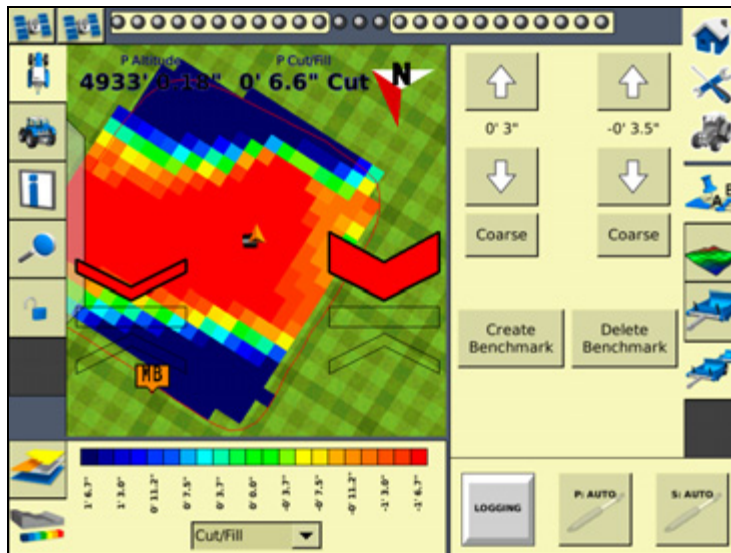

## Leveling model specific information

You have different leveling options, depending on the leveling mode that you selected (see [Step 2. Configuring the leveling model, page 213](#)). For information specific to the leveling model:

- For Point and Slope mode, see below.
- For Flat Plane (Laser) mode, see [page 227](#).
- For Flat Plane (GPS) mode, see [page 227](#).
- For Contour mode, see [page 233](#).

## Driving in Point and Slope mode

When you drive in Point and Slope mode, the *FieldLevel II* tab appears as follows:

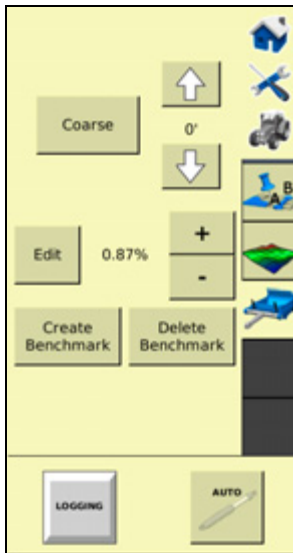

Tap...	To...
Edit	Edit the design slope.
+ button	Increase the design slope by the Slope Adjust amount.
- button	Decrease the design slope by the Slope Adjust amount.
Bench or Rebench	Create a benchmark, see <a href="#">Benchmarks, page 202</a> . Set the Design Height equal to the Blade Height.
Delete Benchmark	Delete any benchmark on the field. <i>Note: You do not have to drive over a benchmark to delete it.</i>
Up Arrow	Raise the blade by the Blade Step amount.
Down Arrow	Lower the blade by the Blade Step amount.
Auto	Engage automatic blade height control: <ul style="list-style-type: none"> <li>• starts the slope calculation</li> <li>• resets the height</li> <li>• resets the cut/fill</li> </ul>
Coarse	Use the Up and Down arrows to change the blade height by the <i>Coarse Blade Step</i> amount. This enables you to move the blade by a large amount instead of small increments.
Logging	Log the coverage, so that you can see on the map where you have been dependent on your Implement Width. A shape file is created with cut/fill and height information

The slope is defined as the percentage vertical drop against horizontal travel. A positive slope goes upwards and a negative slope goes downward. For example, if the slope is set to -1%, the slope will drop 1 ft for every 100 ft horizontally traveled:

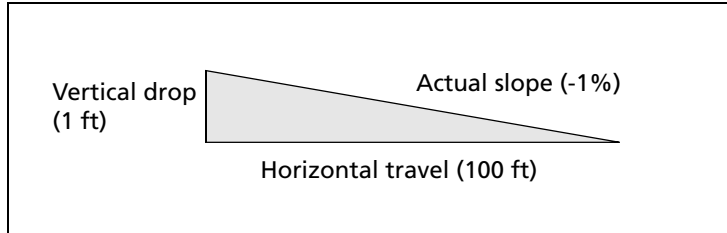

To view or change the Point and Slope gradient, tap **Edit** on the *FieldLevel II* tab. Alternatively, tap the + or - buttons to move the slope by the *Slope Adjust* amount (defined in the *FieldLevel* settings, under *Leveling model - Point and Slope/Slope Adjust*).

### Driving in Flat Plane (Laser) and Flat Plane (GPS) modes

When driving in Flat Plane mode, the *Laser* and *GPS* options operate the same.

The Flat Plane (Laser) model results in a mathematically flat surface. This means that the plane does not follow the curvature of the Earth, but remains on a plane. Use this model when the land has previously been leveled with a laser system and you want to touch up the field.

The Flat Plane (GPS) model results in an equipotential surface meaning that the design surface is curved with surface of the Earth.

**Note** – *Neither of these models can be used with a laser system; the entire FieldLevel II system only works with GPS.*

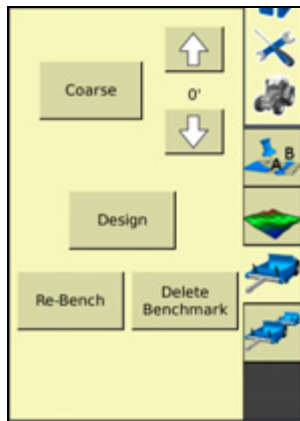

Tap...	To...
Design	enter the Plane Editor where you can edit the Design plane.
Bench or Rebench	create a benchmark, see <a href="#">Benchmarks, page 202</a> . Set the Design Height equal to the Blade Height.
Down Arrow	raise the blade by the <i>Blade Step</i> amount.

Tap...	To...
Up Arrow	lower the blade by the <i>Blade Step</i> amount.
Auto	engage automatic blade height control: <ul style="list-style-type: none"> <li>• starts the slope calculation</li> <li>• resets the height</li> <li>• resets the cut/fill</li> </ul>
Coarse	move the blade by the <i>Coarse Blade Step</i> amount. To do this, press the + or - button.
Delete Benchmark	delete the benchmark at the current location. <b>Note</b> – <i>You do not have to drive over a benchmark to delete it.</i>
Logging	log the coverage, so that you can see on your map where you have been dependent on your implement width. A shape file is created with cut/fill and height information.

## Defining a plane

You can define a plane in the *Plane Editor* on the FmX integrated display. To do this, use at least one point as a pivot point and extra information based on direction and slope requirements.

The following figure show the required elements:

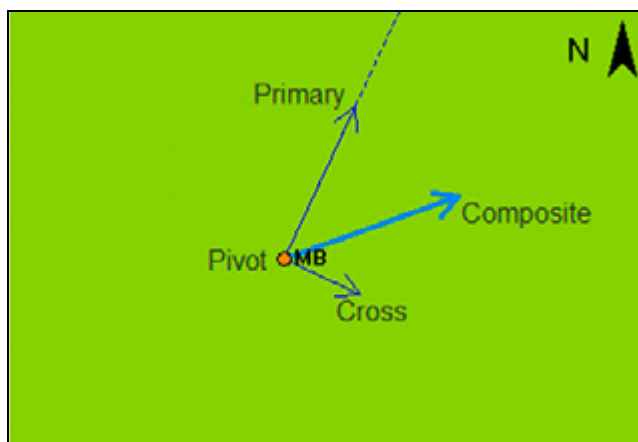

Element	Description
Pivot Benchmark	The single benchmark where the plane is defined. All slopes will pivot around this point.
Primary	The first axis upon which the slope is defined. It has a Primary Slope and Primary Heading component. The Primary Slope is defined as a negative number, where water will fall along the primary axis.
Cross	The second axis upon which the slope is defined. The Cross Heading will always be 90° or 270° from the Primary Heading. The Cross Slope is defined as a negative number, where water will fall along the cross axis. To define the plane by a single heading and slope, then you should set the Cross Slope value to 0.000%
Composite	When both Primary and Cross slopes are defined, the Composite Slope direction shows the actual heading where water will fall. If you have 0.000% slope on the Cross axis, the Composite Heading will be the same as the Primary Heading.

## Defining a plane using a single point

1. From the Run screen, select the Survey/Design plugin and then create a benchmark that will be used to define the direction of the slope and its heading.

**Note** – It can be useful to create the benchmark at the critical point; for example, where the water will enter or exit the field. This ensures that where the benchmark is, the plane is on grade.

2. Select the FieldLevel II plugin and then tap **Design**:

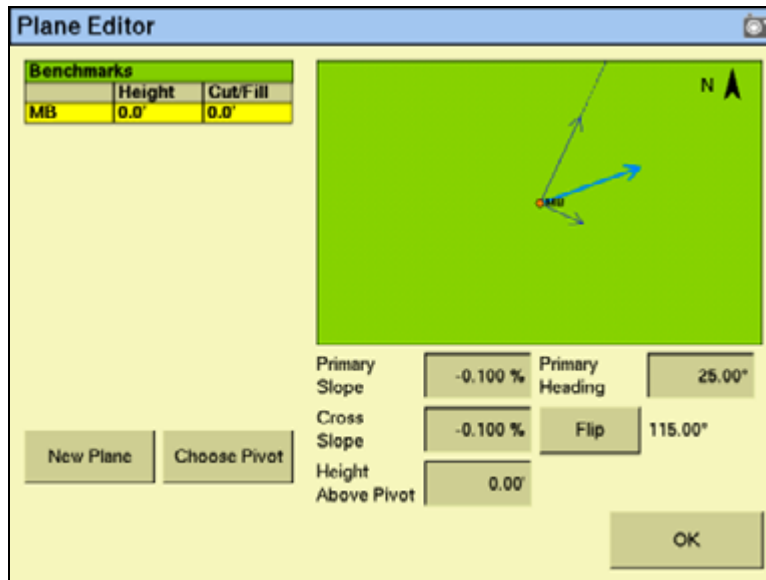

3. If more than one benchmark is stored, tap **Choose Pivot** and then select the benchmark that you want to be on grade.
4. Tap **OK**. The *Plane Editor* screen appears.
5. If using a known offset, enter it into the *Height Above Pivot* field.
6. Enter the values for *Primary Slope*, *Primary Heading*, and *Cross Slope*:
  - For water to run along the Primary and Cross axis, the slope values must be keyed in as negative values.
  - If you want to define the primary heading by measuring a second point, see [Defining a plane using multiple benchmarks, page 230](#).
7. To change the direction of the Cross Slope, tap **Flip**. This changes the *Cross Heading* between 90° and 270° from the *Primary Heading*.
8. The plane is now defined. Tap **OK**. The Run screen appears.

**Note** – The *FieldLevel II* plugin searches for a survey on the field. If there is a survey, a *Cut/Fill* map appears on the new design plane.

## Defining a plane using multiple benchmarks

You can use multiple benchmarks to define a plane based on your specific requirements. If multiple benchmarks are created, you can design a plane of best-fit through those points.

If you use three benchmarks to design the plane, then the cut and fill values will be "0.0" through those points as the plugin can create a perfect plane. If you use more than three benchmarks to design the plane, the cut/fill values will be the residual difference between the plane of best-fit and the benchmark elevations.

To define a plane using multiple points, do the following:

1. From the Run screen, select the Survey/Design plugin and then create two or more benchmarks to help define the plane. If a primary heading definition is required you only need two benchmarks. If all the slopes of a field are to be defined, then you need at least three benchmarks.
2. Select the FieldLevel II plugin and tap the **Design** button. The *Plane Editor* screen appears.
3. Tap **New Plane**:

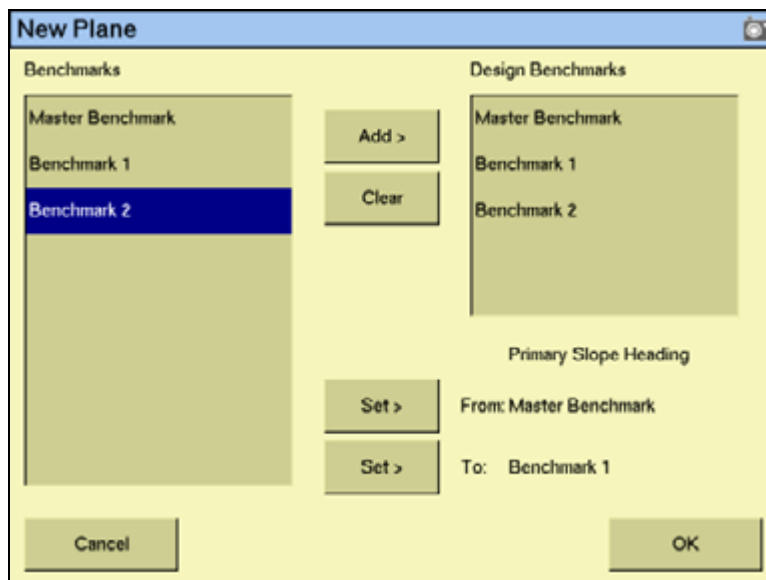

4. From the *Benchmarks* list, select the benchmark to be used as the primary pivot and then tap **Add**. The benchmark is copied to the *Design Benchmarks* list.
5. Repeat Step 4 until all the required benchmarks are copied to the *Design Benchmarks* list. The *Design Benchmarks* list contains the benchmarks for the multi-point plane.
6. To set the *Primary Slope Heading*, choose the first benchmark to define the heading and then tap the *From: Set>* button.

**Note** – It is recommended that this point is the uphill point of the two points to be used to define the primary slope.

7. Select the second point of the primary slope and then tap the *To: Set>* button.

8. Tap **OK**:

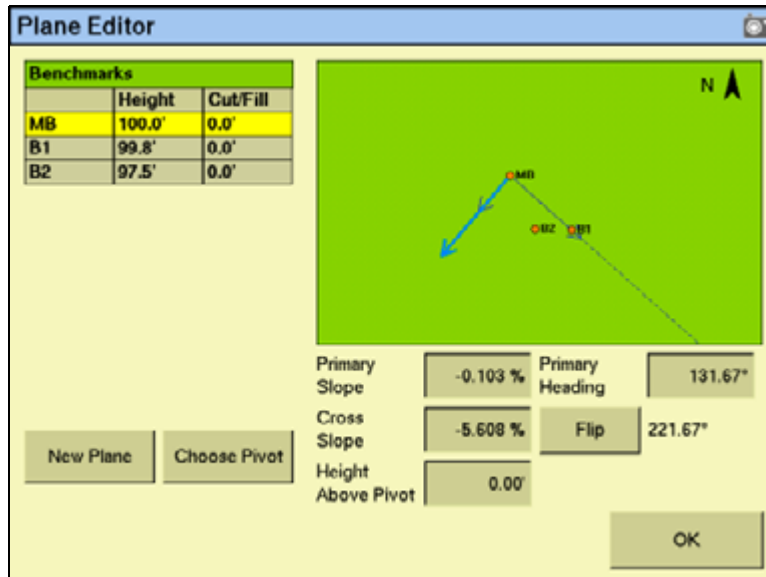

The selected benchmarks appear in the *Benchmarks* table along with their associated cut/fill values. The Primary Slope and Cross Slope values reflect the calculated slopes based on the benchmarks entered in the *New Plane* screen.

9. To update the slope values:
- Identify the benchmark to be used as the new pivot.
  - Tap the **Choose Pivot** button. The *Choose Pivot* screen appears.
  - From the *Choose Pivot* screen, select the benchmark to be used as a the pivot for the new slope from the screen.
  - Tap **OK**. The *Plane Editor* screen appears.

10. Select the *Primary Slope*, *Cross Slope*, or *Height Above Pivot* areas to edit the slope values as required:

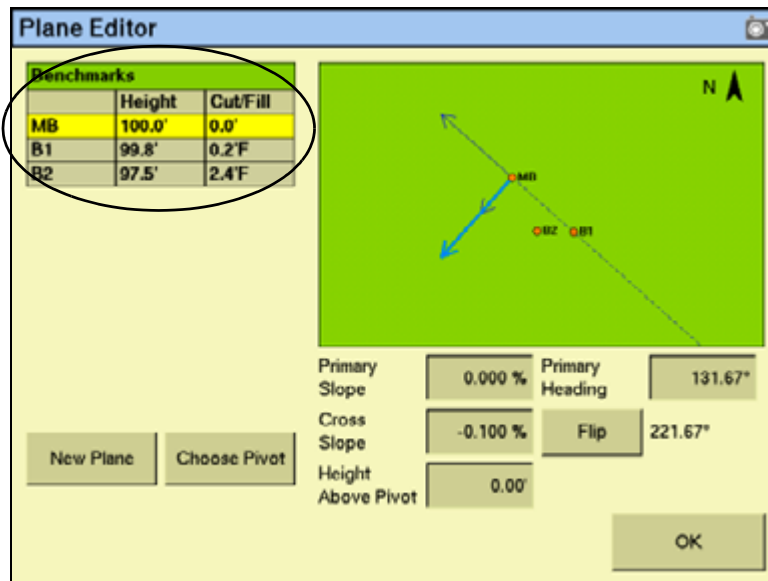

**Note** – The cut/fill values in the Benchmarks table will update automatically.

11. The plane is now defined. Tap **OK**. The Run screen appears.

**Note** – The FieldLevel II system will search for a survey on the field. If there is a survey, a cut/fill map appears as the new design plane.



## Driving in Contour mode

When you drive in Contour mode, the *FieldLevel II* tab appears as follows:

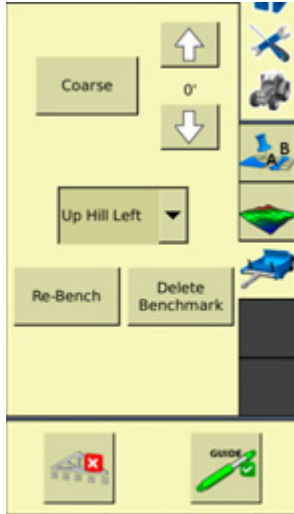

Item	Description
Up Hill Left	Select whichever of these buttons is appropriate:
Up Hill Right	<ul style="list-style-type: none"> <li>If you are driving around the contour with the uphill slope on your left and the downhill slope on your right, select <b>Up Hill Left</b>.</li> <li>If you are driving around the contour with the uphill slope on your right and the downhill slope on your left, select <b>Up Hill Right</b>.</li> </ul>
Coarse	When selected, the Up and Down arrows change the blade height by the <i>Coarse Blade Step</i> amount. This enables you to move the blade by a large amount instead of small increments.
Up arrow	Increase the design height by the Blade Step amount.
Down arrow	Decrease the design height by the Blade Step amount.
Bench or Rebench	Create a benchmark, see <a href="#">Benchmarks, page 202</a> . Set the Design Height equal to the Blade Height.
Guide	Select <b>Guide</b> to get lightbar guidance at the current level.
Logging	Logs the coverage, so that you can see on your map where you have been dependent on your Implement Width. A shape file is created with cut/fill and height information.

The FieldLevel II height indicators show you whether to raise or lower the blade so the contour remains at the same level.

- In the Run screen, drive the vehicle to where you want to start the first levee and then set the master benchmark at this point.
- Set which side of the vehicle is uphill. Tap **Guide**, drive the vehicle forward, following the lightbar to keep the vehicle on the same contour:
  - To move to the next levee, turn the vehicle around and change the *Up Hill* direction.
  - To step the blade up or down, use the **▲** and **▼** buttons to achieve the required offset and then follow the lightbar to keep the correct grade.

## Tandem / Dual plugin

### Tandem scraper configuration

The tandem scraper configuration describes the practice of towing two scrapers, one behind the other. This type of leveling provides increased efficiency as it allows for the blade of each scraper to be controlled independently from the other. This means more dirt can be cut before you have to drive to a fill area and remove dirt from the scraper buckets.

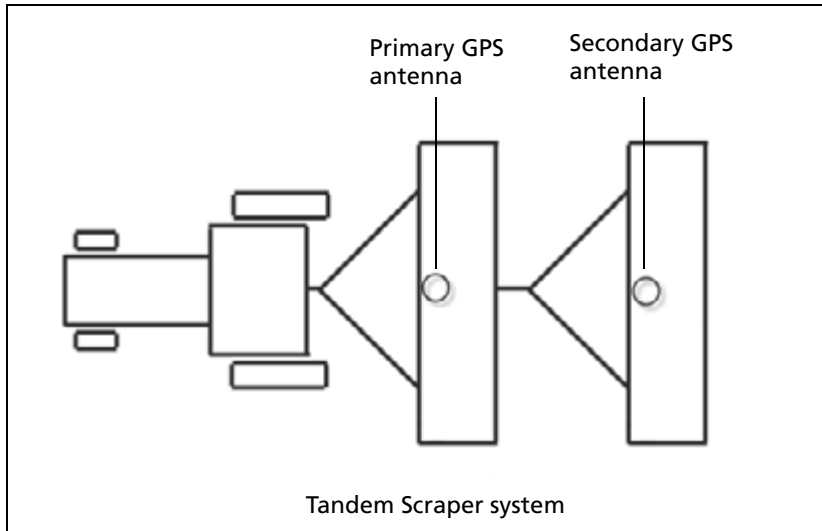

### Dual scraper configuration

The dual scraper configuration describes a single scraper with two GPS antennas, one at each end of the blade. This allows for control of the roll of the blade, giving a more accurate surface. This configuration is ideal for complex surfaces with high variability slopes.

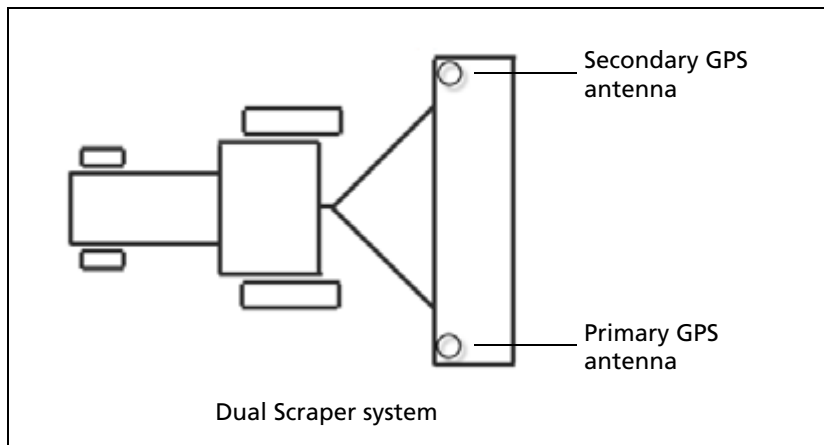

**Note** – For the FieldLevel II dual system you must use a scraper with dual hydraulic controls.

## Configuring the Tandem/Dual plugin

**Note** – Before you can configure the system, it must be professionally installed. For more information, contact your local reseller.

There are six steps to complete:

Step 1. Configuring the implement

Step 2. Preparing the FmX integrated display and antenna connections

Step 3. Configuring the primary receiver

Step 4. Configuring the secondary receiver

Step 5. Configuring the Tandem/Dual plugin

Step 6. Calibrating the Tandem/Dual valve module

### Step 1. Configuring the implement

If you have not already configured the implement, see [Configuring the implement for leveling / drainage](#), page 202.

### Step 2. Preparing the FmX integrated display and antenna connections

If not already installed on the FmX integrated display, install the FieldLevel II plugin, followed by the Tandem/Dual plugin (for more information, see [Adding or removing a plugin](#), page 192)

When both plugins are installed, the *Configuration* screen will show both the FieldLevel II plugin with its associated GPS receiver, and the Tandem/Dual plugin with its associated GPS receiver:

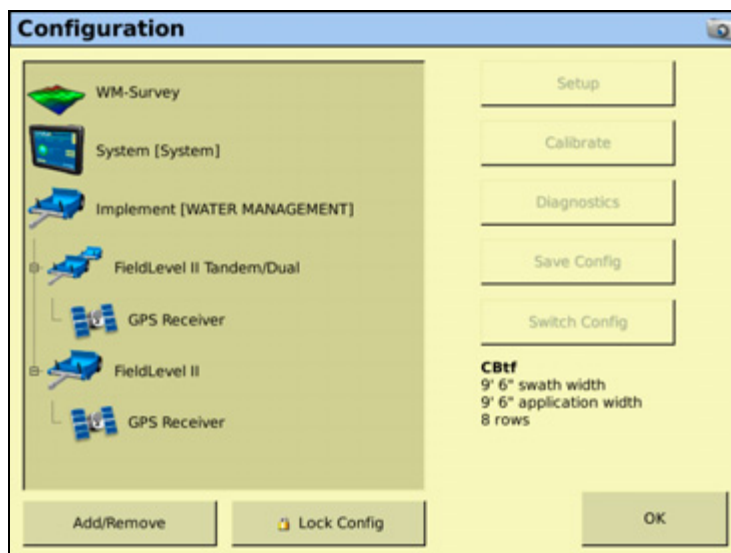

Connect the FieldLevel II plugin (primary) antenna to the GPS1 connector ❶ on the rear of the display, and connect the Tandem/Dual plugin (secondary) antenna to the GPS2 connector ❷ on the rear of the display:



The correct configuration for the antennas on the implement/s is as follows:

FmX integrated display port	Plugin	Receiver position (Tandem set-up)	Receiver position (Dual set-up)
GPS1 ❶	FieldLevel II	Front	Left
GPS2 ❷	Tandem / Dual	Rear	Right

### Step 3. Configuring the primary receiver

The FieldLevel II plugin controls the primary receiver.

1. From the *Configuration* screen, select the GPS receiver listed below the Field Level plugin and then tap **Setup**:
2. From the *Receiver* drop-down list, select *Internal Primary*.
3. From the *Corrections* drop-down list, select *RTK*.
4. Set the *Network ID* field to the same network ID that is set in the base receiver.

### Step 4. Configuring the secondary receiver

The Tandem/Dual plugin controls the secondary receiver.

1. From the *Configuration* screen, select the GPS receiver listed below the Tandem/Dual plugin and then tap **Setup**:
2. From the *Receiver* drop-down list, select *Internal Secondary*.

## Step 5. Configuring the Tandem/Dual plugin

The FmX integrated display must be configured to control the Tandem/Dual plugin in either a tandem configuration or a dual configuration, depending upon the implement/s being used.

1. From the *Configuration* screen, select the Tandem/Dual plugin and then tap **Setup**:

The screenshot shows a dialog box titled "Tandem/Dual Setup". It has a yellow background and a blue title bar. There are three rows of settings:

- Type:** A dropdown menu with "Tandem (Back)" selected.
- Antenna Height:** A text input field containing "8.202'".
- Disengage Raise:** A text input field containing "0.000 s".

At the bottom of the dialog are two buttons: "Cancel" on the left and "OK" on the right.

2. By default, the *Type* field is set to *Tandem (Back)* and can control two implements, one towed behind the other. If a single implement is to be used in a dual configuration, select *Dual (Right)* from the *Type* drop-down list.
3. Enter the appropriate value in the *Antenna Height* field.

This value relates to the antenna installed on either the rear implement, or the antenna installed on the right side of a single implement.

**Note** – In the *FieldLevel II* plugin, the *Antenna Height* value can be altered from the *Blade Settings* tab and relates to the antenna installed on either the front implement, or the antenna installed on the left side of a single implement.

**Note** – Measure the antenna height vertically, from the ground to the base of the antenna

4. Enter the appropriate value in the *Disengage Raise* field.

This value is used to control the rear implement or the right side of a single implement when Auto is disengaged. If you set it to 0.000s then the blade will not move up when you disengage.

**Note** – In the *FieldLevel II* plugin, the *Disengage Raise* value can be altered from the *Blade Settings* tab and relates to the front implement's blade, or the left side of the blade on a single implement.

**Note** – For a tandem system, you will want to move the blade up when Auto is disengaged on both the front and back implements as you will be swapping between the two. For a dual setup with a single implement, it is recommended that you have the left and right Disengage Raise values set to the same value.

### Step 6. Calibrating the Tandem/Dual valve module

When working with a tandem/dual configuration, the valve module must be calibrated for both the FieldLevel II plugin and the Tandem/Dual plugin.

- The Fieldlevel II plugin valve calibration relates to the front implement cylinder in a tandem configuration, or the left side cylinder of a single implement.
- The Tandem/Dual plugin valve calibration relates to the rear implement cylinder in a tandem configuration, or the right side cylinder of a single implement.
- Depending on the make and manufacturer of your vehicle, the tractor computer may need to be put into a special mode. Please refer to the FieldLevel II Installation Guide for your vehicle type.

To calibrate the valve module:

1. From the *Configuration* screen, select the Tandem/Dual plugin and then tap **Calibrate**:

2. Set the vehicle throttle to 100%.
3. Tap **Start**.

The system performs its calibration sequence to test the speed at which the blade raises and lowers. This process takes approximately 8 – 10 minutes.

To manually calibrate the valve, enter values in the three *Manual Calibration* fields and then tap **OK**.

## Operating the Tandem/Dual plugin

### Blade height indicators

Once you install and configure tandem mode (two implements each with a GPS receiver), or dual mode (a single implement with a GPS receiver at each end), a second blade height indicator appears on the Run screen:

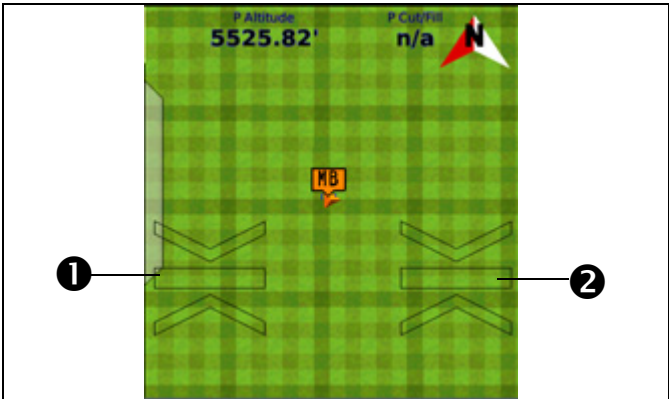

Item	Description
1	Primary (left side) implement height indicator
2	Secondary (right side) implement height indicator

These operate in the same way as the single receiver FieldLevel height indicators. See [Blade position indicators](#), page 220.

### Auto buttons

With a tandem/dual configuration, the Autopilot **Engage** button is replaced with two FieldLevel **Auto** buttons:

- With a tandem configuration, the **P:Auto** button controls the automatics of the primary (front) implement and the **S:Auto** button controls the automatics of the secondary (rear) implement.
- With a dual configuration, the **P:Auto** button controls the automatics on the primary (left) side of the implement and the **S:Auto** button controls the automatics on the secondary (right) side of the implement.



*Note* – To control both sides of the implement simultaneously when using a dual configuration, you must tap both buttons.

*Note* – With the addition of an external GPS receiver, you can use the Autopilot system with tandem and dual systems. An **Engage** button appears next to the **P:Auto** and **S:Auto** buttons.

### The FieldLevel II tab (dual mode)

The *standard* FieldLevel II tab in dual mode has a single set of up and down buttons.

These buttons control the height of the whole implement. Use them to raise or lower both sides of the implement simultaneously. For example, if the blade is on an angle and you raise it with the up arrow on the standard FieldLevel II plugin, the blade remains at the original angle.

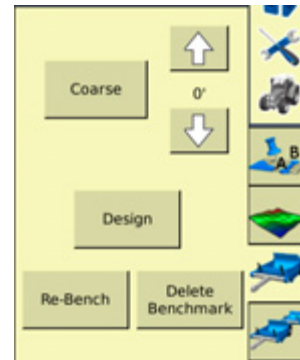

### The Tandem/Dual tab

For both tandem and dual mode, the *Tandem/Dual* tab includes a double set of up and down buttons. These buttons provide independent control of the implement offset:

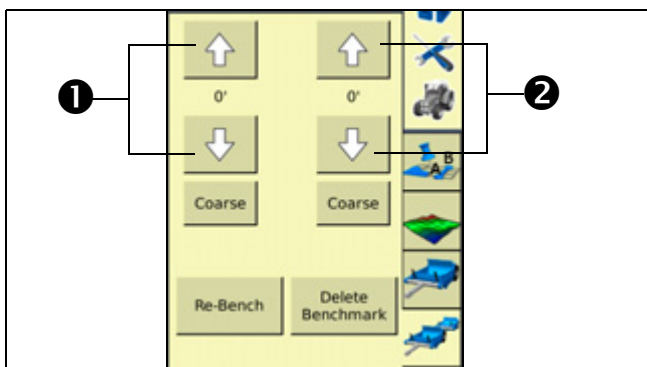

Item	Description
①	Primary (front or left side) implement height control
②	Secondary (rear or right side) implement height control

- For a tandem configuration:
  - the *left* up and down buttons offset the height of the *primary* (front) implement
  - the *right* buttons offset the height of the *secondary* (rear) implement.
- For a dual configuration:
  - the *left* buttons offset the height of the *primary* (left) side of the implement
  - the *right* buttons offset the height of the *secondary* (right) side of the implement.



## WM-Drain plugin

The WM-Drain™ farm drainage solution is a concept to completion toolset that streamlines the survey, analysis, design, installation, and mapping steps of surface and subsurface drainage.

The WM-Drain farm drainage solution is a concept-to-completion toolset that streamlines the survey, analysis, design, installation, and mapping steps of surface and subsurface drainage:

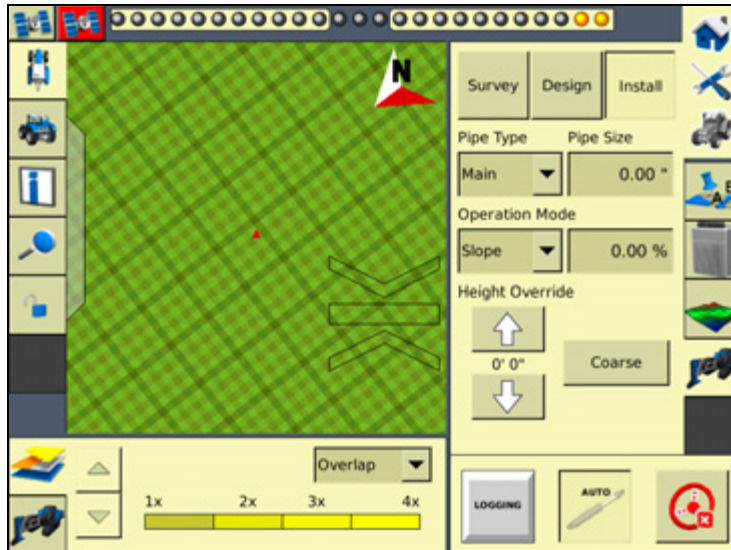

### Configuring the WM-Drain plugin

*Note* – Before you can configure the system, it must be professionally installed. For more information, contact your local reseller.

There are 3 steps to complete:

- [Step 1. Configuring the implement](#)
- [Step 2. Configuring the WM-Drain settings](#)
- [Step 3. Configuring the receiver](#)

#### Step 1. Configuring the implement

If you have not already configured the implement, see [Configuring the implement for leveling / drainage](#), page 202.

## Step 2. Configuring the WM-Drain settings

- From the *Configuration* screen, select the *WM-Drain plugin* and then tap **Setup**:

- Set the following in the *Implement* tab:

Field	Description
Antenna Height Offset	The distance from the antenna to the bottom of the boot.
Survey Height Offset	The distance from the bottom of the blade to the ground when implement is raise all the way up to do a survey.
Survey Point Spacing	Any value between 5 ft and 100 ft. This setting determines the distance between the collected survey mapping points.

3. Select the *Steps* tab and then set the following:

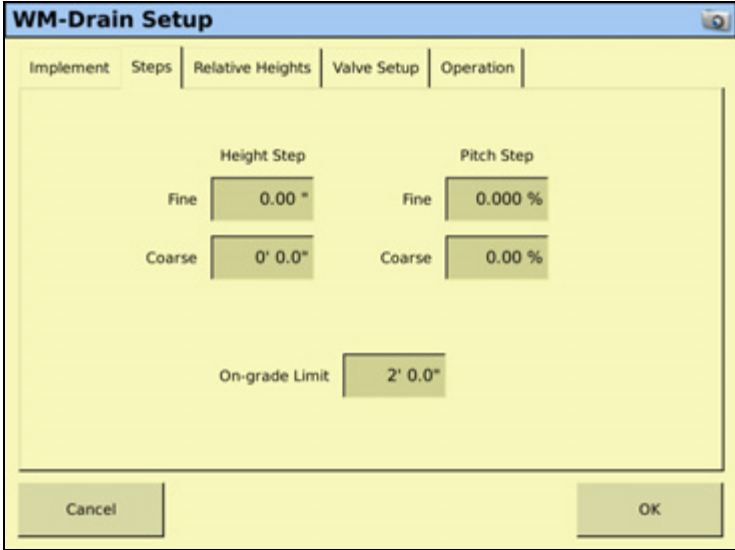

Field	Description
Height Step	<i>Fine</i> allows you to change height steps in small increments. <i>Coarse</i> allows you to change height steps in larger increments.
Pitch Step	<i>Fine</i> allows you to change pitch steps in small increments. <i>Coarse</i> allows you to change pitch steps in larger increments.
On-grade Limit	The limit you enter here sets the distance the blade can move before the green blade height indicators change to a thin red arrow. At twice this distance, the height indicators become thick red arrows. See <a href="#">Blade position indicators, page 220</a> .

4. Select the *Relative Heights* tab and then set the following:

Field	Description
Relative Heights	Select <i>Enabled</i> to use relative heights from the master benchmark. Select <i>Disabled</i> to use GPS heights at all times.
Relative X	If relative heights are enabled, this is the X coordinate that will be applied to the master benchmark.
Relative Y	If relative heights are enabled, this is the Y coordinate that will be applied to the master benchmark.
Height Offset	If relative heights are enabled, this is the height value that will be applied to the master benchmark.

5. Select the *Valve Setup* tab and then set the following:

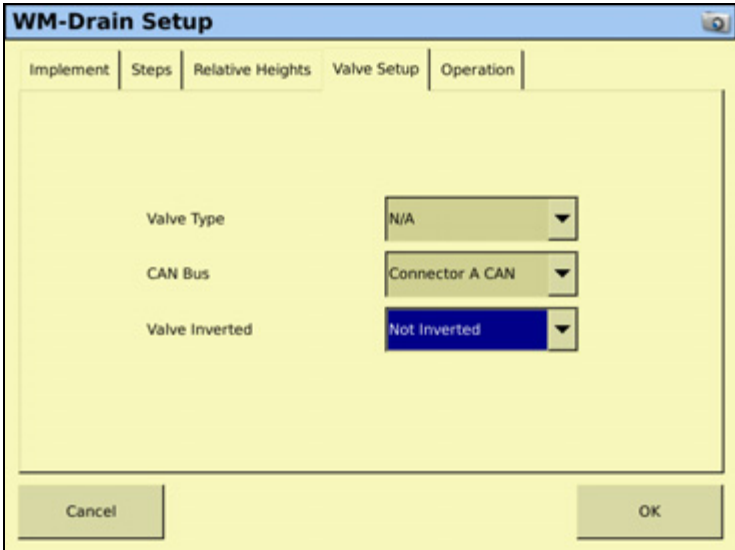

Field	Description
Valve Type	Select the type of valve that is connected.
CAN Bus	Select the port on the FmX integrated display that the valve module is connected to.
Valve Inverted	Leave this field as <i>Not Inverted</i> , unless the tank and pressure hoses have been installed incorrectly on the valve. If this is the case, select <i>Inverted</i> to eliminate the need to reverse the hoses.

6. Select the *Operation* tab and then set the following:

The screenshot shows the 'WM-Drain Setup' dialog box with the 'Operation' tab selected. The settings are as follows:

Field	Value
Force Re-bench	No
VDOP Level	3.0
Filter Type	None

Field	Description
Force Rebench	If Force Rebench is set to Yes, and the field has been closed and then reopened, the system will not let you start work until you have re-benched. Use this setting if you are using a different base station setup between work sessions. If you have a permanent base station setup that is never moved, then you do not need to force a rebench.
VDOP Level	Vertical Dilution of Precision (VDOP) is a measure of the vertical accuracy of the GPS signal. If the VDOP reaches this value, a warning appears. A VDOP Setting of less than 3 is recommended.
Filter Type	The options are: <ul style="list-style-type: none"> <li><i>None</i>: This setting (the raw GPS data used for height) is recommended.</li> <li><i>Average</i>: The height will be averaged using the number of positions selected. This will smooth spikes in height readings but will introduce a latency into the controls.</li> <li><i>Jump detect</i>: This will filter out some jumps in the height readings. When you select this, you must enter the following values: <ul style="list-style-type: none"> <li><i>Threshold</i>: The change in height value that will trigger the value.</li> <li><i>Decay Time</i>: Once this filter is triggered, this will be the amount of time it takes to gradually resume using the raw GPS height.</li> </ul> </li> </ul>

7. Tap **OK**.

### Step 3. Configuring the receiver

- From the *Configuration* screen, select the GPS receiver listed below the WM-Drain plugin and then tap **Setup**:
- From the *Receiver* drop-down list, select *Internal Primary*.
- From the *Corrections* drop-down list, select *RTK*.
- Set the *Network ID* field to the same network ID that is set in the base receiver.

### Calibrating the WM-Drain plugin

The system performs its calibration sequence to test the speed at which the blade raises and lowers. This process takes approximately 8–10 minutes for each valve.

*Note* – To manually calibrate the valve, enter values in the 3 Manual Calibration fields and then tap **OK**.

For the WM-Drain valve:

- 1. From the *Configuration* screen, select the WM-Drain plugin and then tap **Calibrate**:

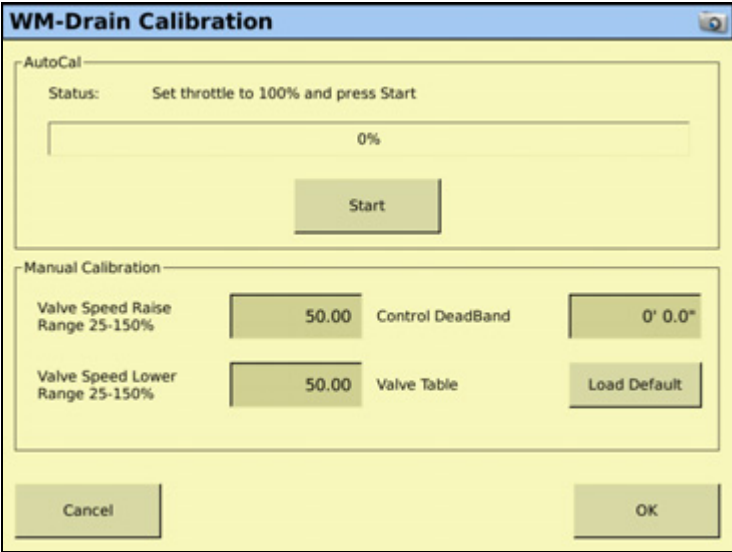

- 2. In the *WM-Drain Calibration* screen, set the vehicle throttle to 100% and then tap **Start**.

### Surveying a section line

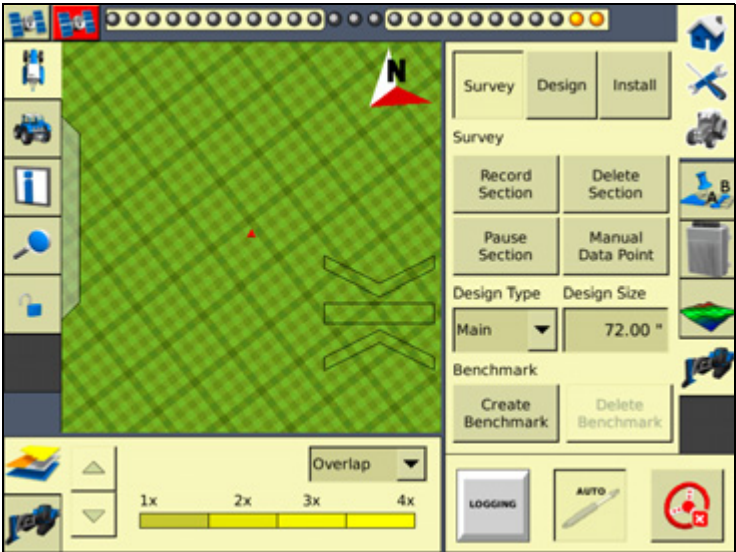

### Surveying your alignment for tile or ditch

Before you begin using Autoslope, you must set the *Survey Height Offset*. This offset will be applied to the heights of your surveyed alignment, preventing the need to rebench before installing tile. This means that you can survey the alignment, and then install tile straight away.

To set the *Survey Height Offset*, do the following:

1. From the *Configuration* screen, select the WM-Drain plugin and then tap **Setup**.
2. On the tile plow, raise the boot as high as it will go and measure the distance from the bottom of the tile boot to the ground:

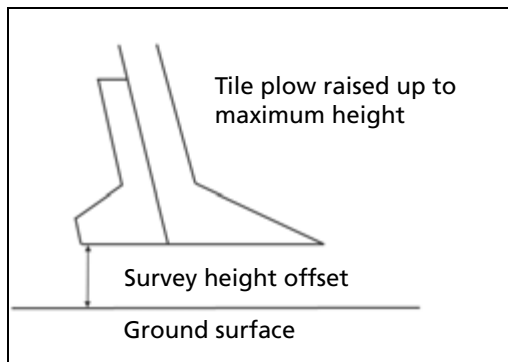

3. Enter this value into the *Survey Height Offset* field:

**Note** – It is recommended that you change the *Survey Point spacing* to 5 ft, this will then record survey points every 1.5m (5 ft) and provide a more accurate profile of the ground surface.

4. Tap **OK**.
5. In the Run screen, drive to a point that will be untouched to use as a reference point. Measure a master benchmark and then flag this point so you can easily find it again.



6. Drive the vehicle to the start of the line where you want to install tile or clean a ditch ( for the most efficient method, it is recommended that this is the high end of the line). Open the *WM-Survey* tab and then select *Survey* at the top of the list. Select the *Design Type* and *Design Size*:



7. Tap **Record** and then drive the line all the way to the end point ( for the most efficient method, it is recommended that the end point is where the tile line is to be connected to a main or outlet). Tap **Record** again to stop the recording.

*Note* – The Record button turn greens when activated, and turns grey when deactivated.

You have now successfully surveyed the line where the tile is to be installed or the ditch is to be cleaned.

## Designing a section line

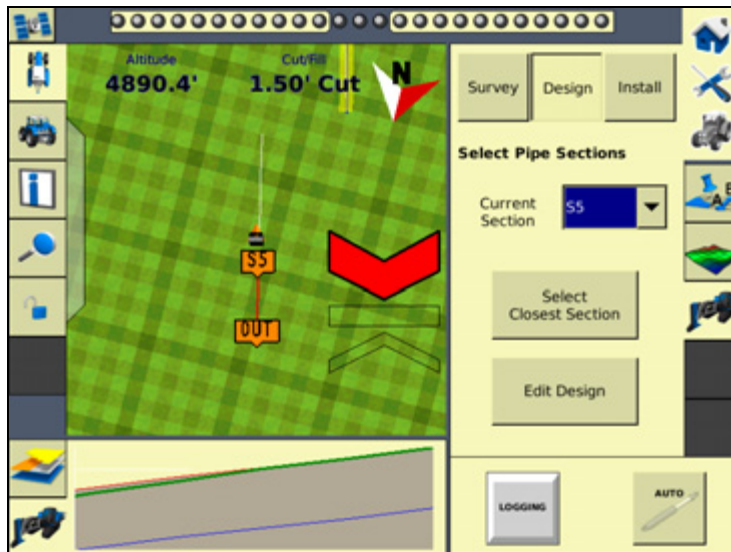

1. From the Run screen, tap **Design** in the *WM-Drain* tab, select the Section Line that you want to design in the *Current Section* field and then tap **Edit Design**:

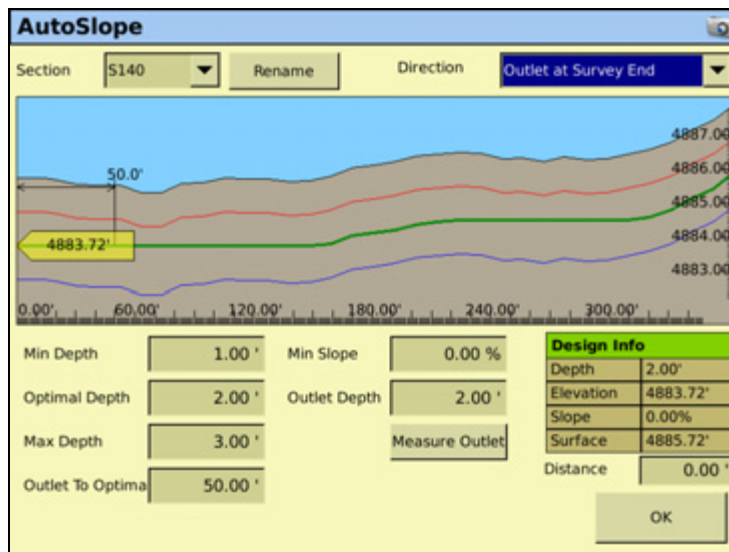

*Design Info* allows you to check the design parameters at any point along the design. Enter the distance in the *Distance* field, or select it by tapping on the screen. The *Design Info* tab will then show the depth, elevation, and slope information for that point.

2. From the *Section* drop-down list, select the section line that you want to design.

**Note** – The section lines are labeled from S1 in the order that they surveyed in.

3. The design screen works from the outlet at the left side of the screen, and runs the design uphill to the right. The direction of the profile is defined by the direction that it was surveyed. If your survey profile is displayed the wrong way around, change the setting in the *Direction* drop-down list from *Outlet at Survey Start* to *Outlet at Survey End*, or from *Outlet as Survey End* to *Outlet at Survey Start*.
4. Edit the constraint fields to your requirements.

Constraint	Description
Section Selection	Auto: the nearest section line is automatically selected. Manual: manually select a section from the drop-down list.
Section Direction	The direction of the profile is defined by the direction that it was surveyed. If you want your profile displayed in the other direction, switch between Outlet at Survey Start and Outlet at Survey End.
Min Depth	The minimum depth for the tile or ditch installation. The system will not allow the design profile to be any shallower than the minimum depth. The minimum depth is shown on the profile as a red line.
Optimal Depth	The depth to install the tile or ditch. The design will keep to this depth where it can. It will move off the optimal depth to be within the other constraints where it needs to.
Max Depth	The maximum depth for the tile or ditch installation. The system will not allow the design profile to be any deeper than the maximum depth. The maximum depth is shown on the profile as a blue line.
Min Slope	The minimum slope for the tile or ditch installation. The system will not allow the design slope to be any less than the minimum slope.
Outlet to Optimal	The distance it takes to change the depth of the design from the <i>Outlet Depth</i> to the <i>Optimal Depth</i> . The tile plow will level out over a longer distance, rather than trying to achieve the depth too quickly at the start of a run.
Outlet Depth	The depth at which the design profile will be at the outlet. The Outlet Depth can either be entered or measured. To measure the Outlet Depth, you can drop the tile plow into the ground so that the boot is at the same height as the main or outlet. Tap <b>Measure</b> ; the outlet Depth is entered automatically. When you do this, another point is added onto the section line, providing that you are within 20m (65 ft) of the end of the surveyed section line. The height of the outlet is displayed on the profile in a yellow tag.

*Note* – For ditching applications, the *Min Depth* and *Optimal Depth* are set close to the surface.

5. Tap **OK**.
6. In the Run screen, you can install the tile or clean the ditch from either the outlet or the top end of the profile. The section line that you install to appears as red on the screen, where other section lines are white.

The virtual lightbar at the top of the FmX integrated display's screen guides you onto the design profile:

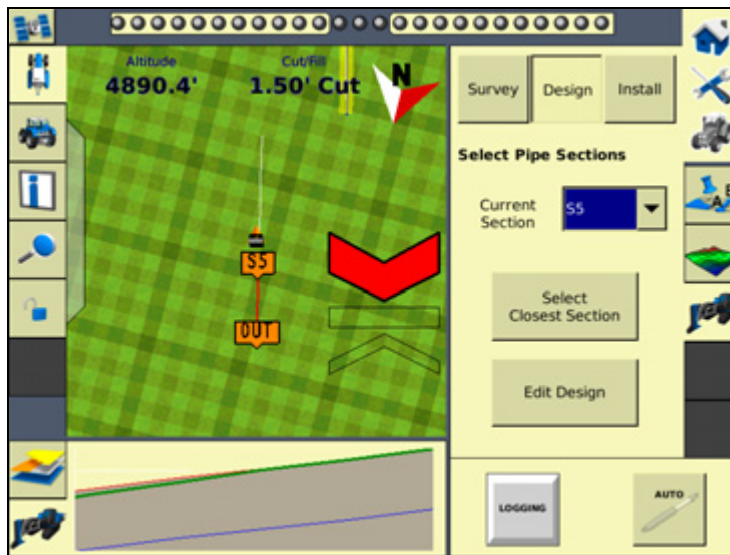

Specifically for the Autoslope leveling model, *P Boot Depth* shows the depth of the tile boot or the blade for ditching applications, and *P Design Slope* shows the current slope that the tile or ditch is being installed to. See [FieldLevel II status text items, page 221](#)).

## Installing a section line

### Driving in Autoslope mode

The Autoslope model can be used for both tile and ditching applications. For tile applications, the system runs on both self-propelled tile machines and pull-type plows towed behind a tractor. For ditching applications, the Autoslope system works with any type of scraper or ditching machine supported by the WM-Drain system.

**Note** – When the system is not running in Auto mode, the virtual lightbar, or LB25 lightbar, will guide to any existing A/B line, allowing you to use manual guidance for surveying in section lines to be tiled at a constant spacing.

When driving in Autoslope mode, the *WM-Drain* tab appears as follows:

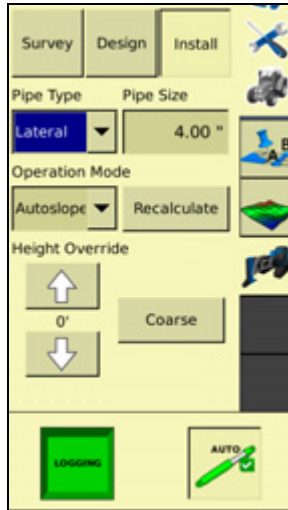

Tap...	To...
Survey	Go to the <i>Survey Work</i> pane, where you can survey the section line you will design.
Design	Go to the <i>Design Work</i> pane, where you can select a section line and then edit the design. <b>Note</b> – A white cross is displayed on the run screen, showing both horizontal and vertical location. See screenshot below table.
Pipe Type	Select the type of pipe you will install.
Pipe Size	Select the pipe size you will install.
Up arrow	Raise the tile boot or blade by the Blade Step amount.
Down arrow	Lower the tile boot or blade by the Blade Step amount.
Recalculate from here	When the tile plow encounters a rock, pull the boot up over the rock then press <b>Recalculate From Here</b> . This will modify the design to ensure that the rest of the tile run stays within the minimum slope requirement, preventing the pipe from diving down to the original design grade. <b>Note</b> – This feature works only when installing tile in the direction away from the outlet point.
Coarse	When selected, pressing the Up or Down arrows will move the blade by the <i>Coarse Blade Step</i> amount. This enables the operator to move the blade by a large amount instead of small increments.
Auto	Set Automatics to the hydraulic valve. The blade or tile boot will be driven to the design depth depending on where you are relative to the section line.
Logging	Log the coverage, so that you can see on your map where you have been dependent on your Implement Width. A shape file will also be created with cut/fill and height information.

## Driving in Point and Slope mode

When you drive in Point and Slope mode, the *WM-Drain* tab appears as follows:

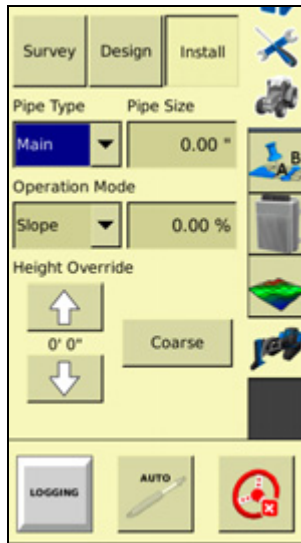

Tap...	To...
Survey	Go to the <i>Survey Work</i> pane, where you can survey the section line you will design.
Design	Go to the <i>Design Work</i> pane, where you can select a section line and then edit the design. <b>Note</b> – A white cross is displayed on the run screen, showing both horizontal and vertical location. See screenshot below table.
Pipe Type	Select the type of pipe you will install.
Pipe Size	Select the pipe size you will install.
Up arrow	Raise the tile boot or blade by the Blade Step amount.
Down arrow	Lower the tile boot or blade by the Blade Step amount.
Slope	Select a defined percentage of vertical drop for a horizontal distance traveled.
Coarse	When selected, pressing the Up or Down arrows will move the blade by the <i>Coarse Blade Step</i> amount. This enables the operator to move the blade by a large amount instead of small increments.
Auto	Set Automatics to the hydraulic valve. The blade or tile boot will be driven to the design depth depending on where you are relative to the section line.
Logging	Log the coverage, so that you can see on your map where you have been dependent on your Implement Width. A shape file will also be created with cut/fill and height information.

The slope is defined as the percentage vertical drop against horizontal travel. A positive slope goes upwards and a negative slope goes downward. For example, if the slope is set to -1%, the slope will drop 1 ft for every 100 ft horizontally traveled:

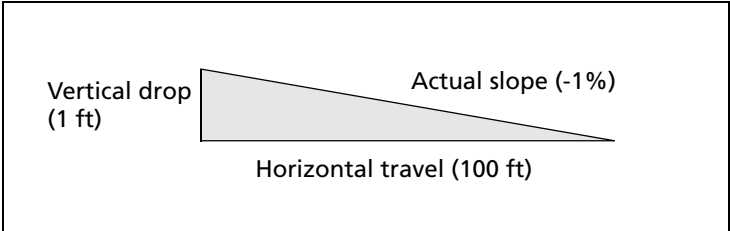





## The Field-IQ Plugin

### In this chapter:

- Introduction
- Installing the Field-IQ hardware
- Field-IQ master switch box functions
- Field-IQ 12-section switch box (optional)
- General setup information
- Linking materials
- Setting up the Field-IQ system for Planting
- Setting up the Field-IQ system for Air Seeding
- Setting up the Field-IQ system for Spraying
- Setting up the Field-IQ system for Spreading
- Setting up the Field-IQ system for Anhydrous
- Using the Diagnostics tab

This chapter describes how to calibrate, configure, and operate the Field-IQ™ crop input control system with the FmX integrated display.

## Introduction

When the Field-IQ plugin is installed, the FmX integrated display can control planters, sprayers, air seeders, liquid strip-till tool-bars, and spinner spreaders. It can perform automatic section control using Tru Count air clutches, boom valves, LiquiBlock, and various section control devices while also controlling rates using a prescription with Rawson drives, servo valves, PWM valves, and various flow control devices. This chapter explains how to configure and use the Field-IQ plugin.

Different functions of the plugin can be configured and controlled by Field-IQ as follows:

Application	Main functions
Planter	<ul style="list-style-type: none"> <li>Seed Section Control of up to 48 individual rows (Field-IQ section control module(s) needed) using Tru Count air clutches.</li> <li>Seed Rate Control using up to 4 Rawson drives to change seed population.</li> <li>Seed Rate control using up to 4 PWM drives to change seed population.</li> <li>Liquid Fertilizer Control of up to 48 individual liquid nozzles (Field-IQ section control module(s) needed) using Tru Count LiquiBlock valves.</li> <li>Variety tracking.</li> </ul>
Sprayer	<ul style="list-style-type: none"> <li>Liquid Rate Control, using either a PWM or Servo control valve.</li> <li>Liquid Section Control of up to 48 individual spray nozzles (Field-IQ Section Control Module(s) needed) using existing boom shutoff valves or Tru Count LiquiBlock valves.</li> </ul>
Strip-till (liquid)	<ul style="list-style-type: none"> <li>Liquid Section Control of up to 48 sections or individual sections (Field-IQ Section Control Module(s) needed) using Tru Count LiquiBlock valves.</li> <li>Liquid Rate Control using up to 2 Rawson drives connected to <b>fixed displacement pumps</b>, such as CDS-John Blue piston pumps, to change liquid rate (Field-IQ Rawson Control Module(s) needed).</li> <li>Liquid Rate Control using either a PWM or Servo control valve and flow meter.</li> </ul>
Spreading	<ul style="list-style-type: none"> <li>Spreading Rate Control using a Rawson Drive (Field-IQ Rawson Control Module(s) needed).</li> <li>Spreading Rate Control using either a PWM or Servo control valve and application rate sensor.</li> </ul>
Air seeder	<ul style="list-style-type: none"> <li>Section Control of up to 96 rows of blockage sensors.</li> <li>Section Control of multiple materials simultaneously with manual rate or prescription.</li> <li>Control existing PWM, linear actuators, or servo systems.</li> <li>Auxiliary sensors can read fan speed, bin level, air pressure, and implement switches.</li> </ul>

## Definitions

Term	Definition
Material	A product that is controlled by a PWM valve, Servo valve, or Rawson drive. You can use a planter (seed), liquid, granular seed and granular fertilizer, all of which have different set-up parameters.
Section	A number of rows or spray nozzles that are controlled by existing shut-off valve, Tru Count air clutches, or Tru Count LiquiBlock valves. A section can have either a single row/nozzle or multiple rows/nozzles depending on how the system is set up.
Row	The individual row unit which seed comes from on the planter. This can be controlled individually as a single row section, or as a group with other rows in a multiple row section.

## Units of measure

Type	Unit	Symbol	Description
Seed	Metric	kS/ha	Thousands of seeds per hectare
	US/Imperial	kS/a	Thousands of seeds per acre
Granular seed	Metric	kg/ha	Kilograms of seed per hectare
	US/Imperial	lbs/a	Pounds of seed per acre
Liquid application	Metric	L/ha	Liters per hectare
	US/Imperial	Gal/a	Gallons per acre
Granular fertilizer	Metric	kg/ha	Kilograms of fertilizer per hectare
	US/Imperial	lbs/a	Pounds of fertilizer per acre

## Installing the Field-IQ hardware

For information on installing the Field-IQ crop input control system on your implement, refer to:

- *Field-IQ Platform Installation Instructions*
- *Tru Count Air Clutch Installation Instructions*
- *Rawson Installation Instructions*

For the latest versions of these documents, go to [www.trimble.com/agriculture](http://www.trimble.com/agriculture).

**Note** – *When using Rawson drives and when using more than one material, you must have a separate Section Control Module (SCM) for materials using Rawson drives.*

## Field-IQ master switch box functions



	Feature	Function
1	Increment/decrement switch	Increases the applied amount by a set amount (the amount is set in the <i>Setup</i> screen, <i>Rate</i> tab).
2	Rate switch	Choose to use preset Rate 1, preset Rate 2, or Manual rate.
3	LED indicator	Red: Unit is powered but not communicating with the FmX integrated display. Green: Unit is powered and communicating with the FmX integrated display. Yellow: Unit is initializing communications with the FmX integrated display.
4	Automatic/Manual section switch	Automatic mode: The FmX integrated display automatically opens and closes sections when entering areas of overlap, non-apply zones, or crossing boundaries. Manual mode: The sections are controlled by the user using the Field-IQ system.  💡 <b>Tip</b> – You can switch from Automatic to Manual mode while traveling.
5	Master switch	<ul style="list-style-type: none"> <li>5a: Jump start position. The same functions as in Master On are active, plus the system is overridden to use a preset control speed (the speed is set in the <i>Setup</i> screen, <i>Override</i> tab).</li> <li>5b: On position. The sections and rate are ready to be commanded by the FmX integrated display.</li> <li>5c: Off position. Sections are closed and rate is set to zero.</li> </ul> <p><b>Note</b> – When you use Lock in Last Position, the valve is locked and the rate is controlled by an auxiliary master valve or section.</p> <p>💡 <b>Tip</b> – Use the jump start function if you lose a GPS signal or you want to start applying before your implement is up to speed.</p>

*Note* – All systems must have a Field-IQ master switch box.

## Field-IQ 12-section switch box (optional)

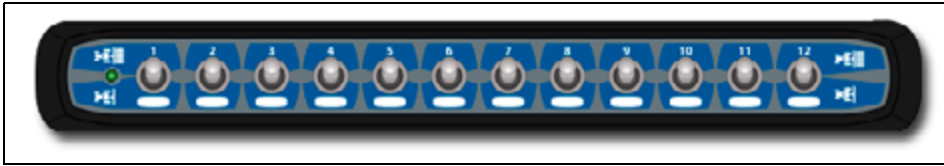

Only one section switch box can be used on each system. Each section switch is automatically assigned to the corresponding section. The sections are read from left to right. For example, switch 1 assigns to the section furthest on the left when standing behind the implement. For more information, see the Hardware tab in *Setup* screen of the Field-IQ plugin.

The section switches have different functions, depending upon the status of the master Automatic/Manual section control switch on the master switch box.

When the Automatic/Manual section control switch is in the **Automatic** position:

- If the section switch is in the on/up position the section(s) assigned to it are commanded automatically by the FmX integrated display.
- If the section switch is in the off/down position the section(s) assigned to it are commanded to be off.

When the Automatic/Manual section control switch is in the **Manual** position:

- If the section switch is in the on/up position, the section(s) assigned to it are commanded to be on. This overrides the FmX integrated display and coverage logging is ignored.
- If the section switch is in the off/down position, the section(s) assigned to it are commanded to be off. This overrides the FmX integrated display and coverage logging is ignored.

The LED has the following status indicators:

- Green – The unit is powered and is communicating with the FmX integrated display.
- Yellow – The unit is initializing communications with the FmX integrated display.
- Red – The unit is powered but not communicating with the FmX integrated display.

## Field-IQ Run screen

The Field-IQ Run screen has three pages:

- Page 1—shows current information about an event and allows you to manipulate the materials and sections.
- Page 2—shows additional information on the current event.
- Page 3—shows row details.

Click the arrow key to move between the pages.

The following shows the Field-IQ run screen with the main plugin screen:

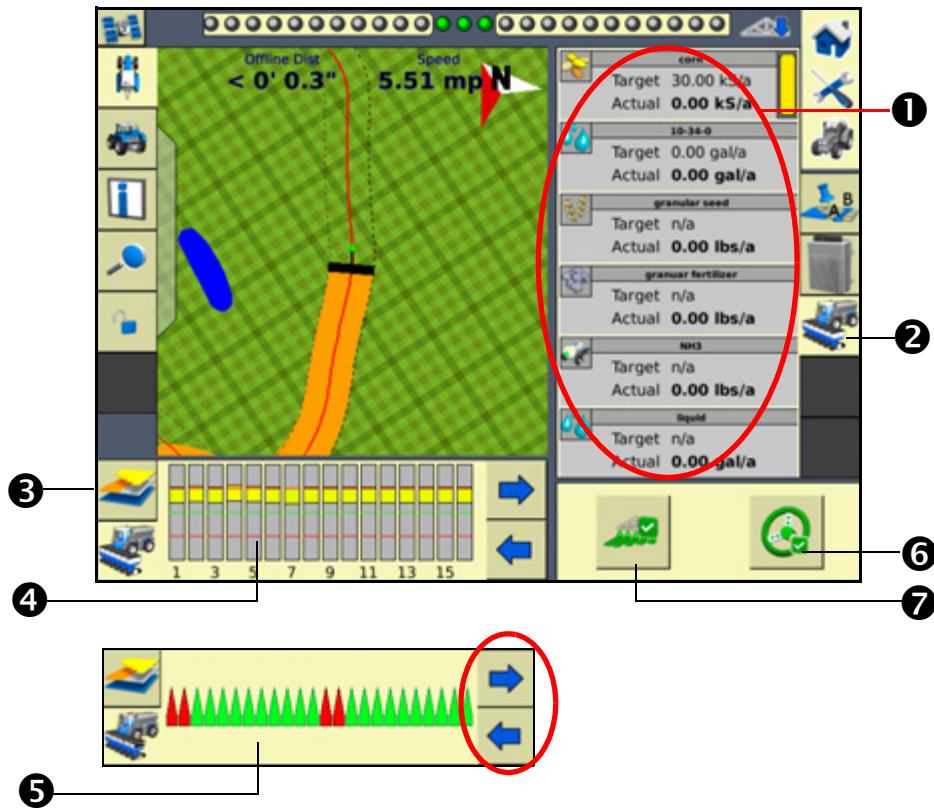

	Feature	Description
1	Materials list	Up to 6 materials are listed. The current <i>Target</i> and <i>Actual</i> rates are shown for each material. Tap a material to show details of that material (see following page).
2	Field-IQ Plugin icon	
3	Mapping Information tab	Change the mapping information that appears on your screen. See <a href="#">Mapping information tab, page 48</a> .
4	Row Status Indicator tab	There are various shades of green, yellow, and red. These shades reflect how far off target the rows are applying. Green: Rows are applying on target. Red: Rows are applying off target. Black: Rows have been manually turned off. White: Rows have been turned off automatically by the system.
5	Field-IQ Status tab	Shows the engage status of each row on the implement: Green: Engaged. Gray: Section closed due to overlap. Red: Not engaged or section manually turned off. Tap the blue arrows to toggle between the Row Status Indicator tab 4 and the Field-IQ Status tab.
6	Engage button	Green: Auto guidance engaged. Gray: Auto guidance can be engaged. Red: Auto guidance cannot be engaged.

	Feature	Description
7	Logging button	Green: Logging enabled. Red: Logging.

Tap a material (in this example, Corn) to view more details:

Page 1 of the plugin tab

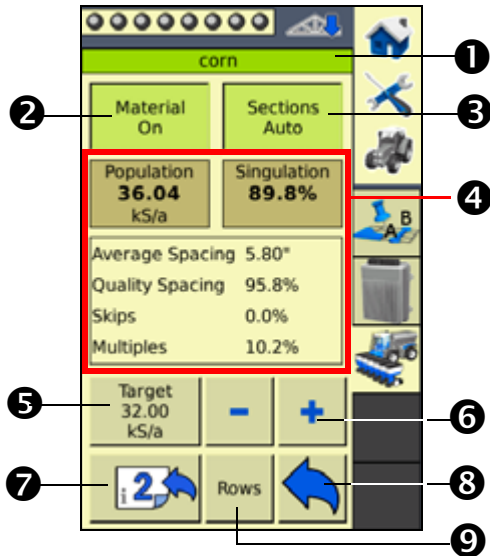

Page 2 of the plugin tab

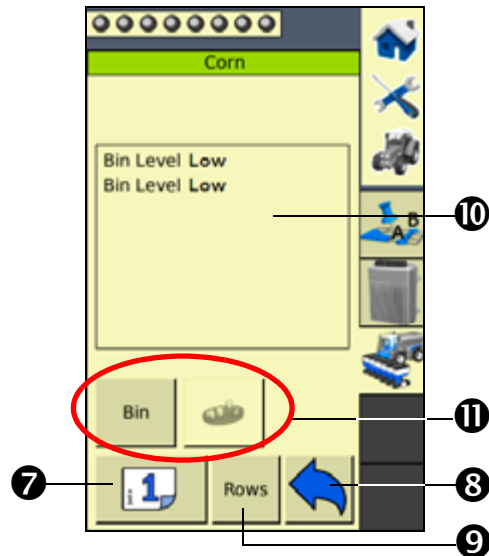

Row Details tab

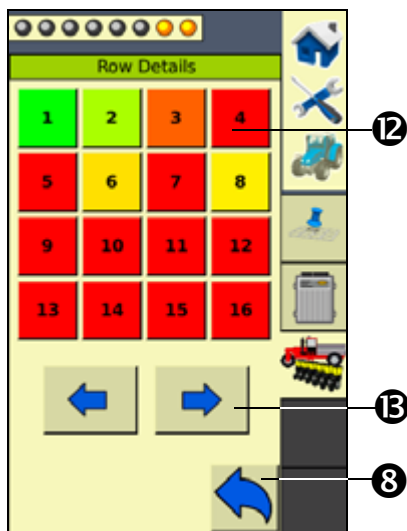

	Description
1	The name of the material you are viewing.
2	Tap to turn the material on or off.
3	Tap to turn auto-section control on or off.
4	Current information about the event.

	Description
5	Target rate. Tap the button to select if Target 1 or Target 2 is shown, or to select Manual to turn the Target rate off.
6	Tap the - button to decrease the Target rate by 1; tap the + button to increase the Target rate by 1.
7	Tap to go to page 1 or to page 2 of the plugin tab.
8	Tap to return to the previous plugin screen.
9	Tap to go to the <i>Row Details</i> tab.
10	Current sensor status.
11	Depending on the material, the following buttons appear: Bin: Tap to go to the <i>Virtual Bin / Tank Setup</i> screen where you can adjust the bin settings. Seed Disc: Tap to fill the seed disk. Arm Pump: Tap to enable Field-IQ to control the pump. Gate Setup: Tap to go to the <i>Gate Setup</i> screen. Density: Tap to go to the <i>Density</i> screen where you can enter the density of the current product.
12	There are various shades of green, yellow, and red. These shades reflect how far off target the rows are applying. Green: Rows are applying on target. Red: Rows are applying off target. Black: Rows have been manually turned off. White: Rows have been turned off automatically by the system.
13	Tap the arrows to view more row numbers.

## General setup information

Do the following prior to setting up the Field-IQ system for planting, spraying, and so on.

Before starting the Field-IQ plugin setup on the FmX integrated display, ensure that:

- all components of the system are installed on the vehicle and implement.
- the Field-IQ plugin has been added to the FmX integrated display configuration. See [Adding or removing a plugin, page 192](#).
- the implement has been set up and configured for the appropriate operation, such as planting or spraying. See [Chapter 7, Implement Configuration](#).

### The Field-IQ Setup Wizard

The FmX integrated display contains a *Field-IQ Setup Wizard* that steps you through setting up the Field-IQ system. You must enter accurate values on each screen of the wizard to ensure that the system operates correctly.

To navigate the wizard:

- Tap **Next** to proceed to the next screen.
- Tap **Back** to return to the previous screen.
- To enter a number or a name, tap in the blank field to open the virtual keypad or keyboard.



**Note** – When you have completed the setup wizard once, the **Next** button is replaced with **OK**. You can then view each tab by tapping it on the screen.

To access the Field-IQ setup wizard:

1. In the *Configuration* screen, select the Field-IQ plugin and then tap **Setup**. The *Material Overview* screen appears:

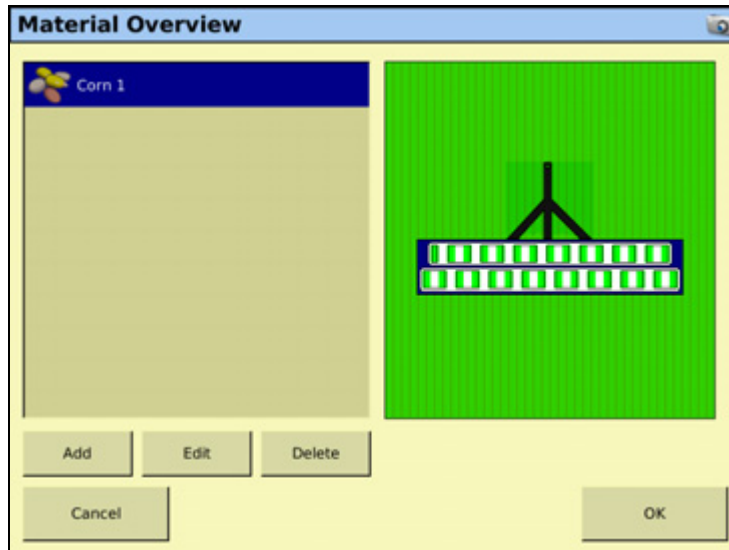

The *Material Overview* screen displays the materials that are currently set up to be applied with the Field-IQ system.

2. Do the following:

Tap...	To...
<b>Add</b>	add and set up a new material
<b>Edit</b>	view or edit the details of an existing material
<b>Delete</b>	delete an existing material

3. When you tap **Add** or **Edit**, the *Field-IQ Setup Wizard* appears. The wizard contains seven tabs. The information that appears on each tab depends on the operation you are setting up. Enter accurate information into each field of the wizard.

## Linking materials

The Field-IQ system can link primary and secondary materials, where the secondary material uses the output of the primary material. For example, LiquiBlock valves can be linked to use the output of Tru Count Air Clutch systems.

When planting, seeding, or strip-tilling, you can link the following together:

- Liquid
- Granular seed

- Granular fertilizer

Anhydrous cannot be linked.

When the system is in diagnostics mode, the secondary material is not functional.

When the system is in diagnostics mode, you can only operate a linked material when you also open the sections of the primary material.

1. In the *Section Control* tab, in the *Section Control* field select *Link to Material*:

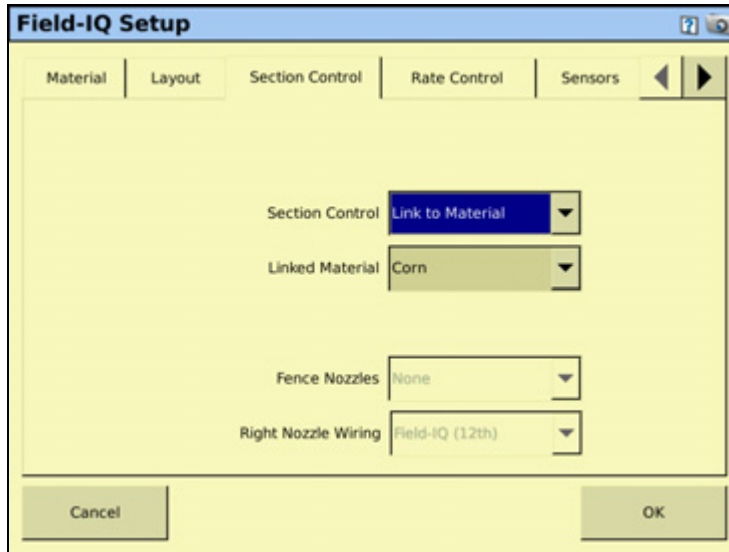

2. In the *Linked Material* field, select the primary material that you want to link to.
3. Select the *Rate Control* tab and then set up rate control.

For more information, see the sections for each type below.

## Setting up the Field-IQ system for Planting

Make sure that you have set your implement to Planter, and that you have configured the implement, see [Configuring the display, page 73](#). In the *Material Overview* screen, tap **New** to open the Field-IQ Setup Wizard. The Wizard contains the following seven tabs:

For information on this tab...	See...
Material	<a href="#">page 263</a>
Layout	<a href="#">page 265</a>
Section Control	<a href="#">page 266</a>
Rate Control	<a href="#">page 268</a>
Row Monitoring	<a href="#">page 271</a>
Sensors	<a href="#">page 272</a>
Operation	<a href="#">page 273</a>

### Material tab

Enter information about the material you want to set up.

Setting	Description
Material Type	Select your Field-IQ application type: <b>Note</b> – <i>If spraying chemicals, use the liquid fertilizer setting.</i> <ul style="list-style-type: none"> <li>• Row Crop Seed</li> <li>• Liquid</li> <li>• Granular Seed</li> <li>• Granular Fertilizer</li> <li>• Anhydrous</li> </ul>
Material Name	Use the virtual keyboard to enter a name for the material.
Material Details	Tap <b>Setup</b> to open the <i>Hybrid Setup</i> screen. See <a href="#">Logging varieties, page 65</a> .

Setting	Description
Application Rate	<p><b>Rates tab</b></p> <p>Adjust the following Rate settings:</p> <ul style="list-style-type: none"> <li>• Target Rate: This setting controls the volume that the implement supplies when the Rate switch is in position 1.</li> <li>• Target Rate 2: This setting controls the volume that the implement supplies when the Rate switch is in position 2.</li> <li>• Rate Increment: When the Rate switch is in the Rate 1 or Rate 2 position, the current application rate increases or decreases by this amount each time you press the Rate adjustment (increment/decrement) switch on your master switch box.</li> <li>• Manual Rate Increment: When the Rate switch is in the Manual position, the current application rate increases or decreases by this amount each time you press the Rate adjustment (increment/decrement) switch on your master switch box.</li> <li>• Minimum Rate: This setting is the minimum rate that will be applied.</li> <li>• Maximum Rate: This setting is the maximum rate that will be applied</li> </ul> <hr/> <p><b>Units tab</b></p> <p>Adjust the following Unit settings:</p> <ul style="list-style-type: none"> <li>• Seeds Per Pound: Enter the number of seeds per pound of the current material.</li> <li>• Target Rate Units: Choose what units your target rate will apply.</li> <li>• Bushel Weight: Enter the bushel weight of the current material.</li> </ul>
Rate Alarms	<p>Tap <b>Setup</b> to set alarm thresholds and adjust the way seed statistics are calculated:</p> <ul style="list-style-type: none"> <li>• High Alarm: Triggers when the rate reaches the selected percentage above the target for longer than the delay setting.</li> <li>• Low Alarm: Triggers when the rate drops the below the target for longer than the delay setting for the selected percentage.</li> <li>• Singulation Low: Triggers when singulation reaches a percentage lower than 100% for longer than the delay setting.</li> <li>• Seeds When Off: Triggers when this percentage of seeds is detected while the sections are off for longer than the delay setting.</li> <li>• No Seeds When On: Triggers when this percentage of seeds is not detected for longer than the delay setting.</li> <li>• Blockage Sensitivity/Alarm: When less than this amount of material is sensed for the number of seconds given.</li> <li>• When no pulses are sensed for this amount of time the alarm triggers.</li> <li>• Multiples Threshold: If two seeds fall within this percentage of seed spacing it is considered a double. Lowering this number requires seeds to be closer together to be reported as a double.</li> <li>• Skips Threshold: If two seeds fall outside of this percentage of seed spacing it is considered a skip. Raising this number requires seeds to be further apart to be a skip.</li> <li>• Averaging Sample Size: This is the number of seeds used to calculate the average. Increasing this amount makes the response slower but more stable.</li> <li>• Misplaced Seeds Threshold: If a seed falls outside this percentage of seed spacing then it's considered misplaced and reduces the spacing quality.</li> </ul>

## Layout tab

Enter information about the implement that will be used to apply the material.

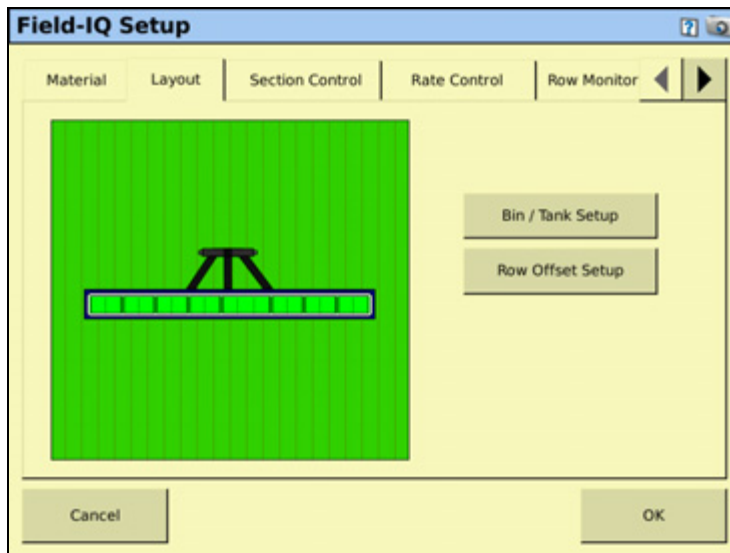

Setting	Description
Bin/Tank Setup	<p>Allows the system to track how much material is left in the bin/tank, and provides a warning when the bin/tank needs to be refilled. Adjust the settings for:</p> <ul style="list-style-type: none"> <li>• Status: <ul style="list-style-type: none"> <li>On: The system will track the bin/tank level and provide warnings.</li> <li>Off: The system will not track the bin/tank level or provide warnings.</li> </ul> </li> <li>• Capacity Units: Select Default Units or Bushels. Default units will vary according to the type of material that is being applied.</li> <li>• Bin Capacity: The amount the tank/bin holds when full.</li> </ul> <p><b>Note</b> – <i>Markings on tank/bin may not be accurate.</i></p> <ul style="list-style-type: none"> <li>• Current Volume: Current volume of the product in the tank.</li> <li>• Partial Refill: The amount of material that will be added to the bin/tank during a partial refill.</li> <li>• Warning Level: A warning will appear on your screen when your bin/tank reaches a set threshold.</li> <li>• Refill Tank/Bin: Refills the tank/bin to capacity.</li> <li>• Partial Refill Tank/Bin: Refills the tank/bin to the amount specified in the <i>Partial Refill</i> field.</li> </ul>

Setting	Description
Row Offset Setup	<p>Row Offset Setup provides additional tuning by detailing where the material will be applied in relation to the vehicle. Increase coverage accuracy by selecting one or two offsets.</p> <p>Row offsets are measured from the Application Offset that is entered in the Measurements tab of the Implement Configuration wizard. See Implement Configuration, Measurements, page 165.</p> <ul style="list-style-type: none"> <li>• Number of row offsets: Use 1 row offset when coverage is applied at a single location. Use two row offsets when planting singulated seed with staggered implements.</li> <li>• Row Offset (1 row offset): Enter the distance between the Application Offset and the row.</li> <li>• Rear Row Offset (2 row offset): Enter the distance between the Application Offset and the rear row.</li> <li>• Front Row Offset (2 row offset): Enter the distance between the Application Offset and the front row.</li> </ul>

### Section Control tab

Adjust the section control settings.

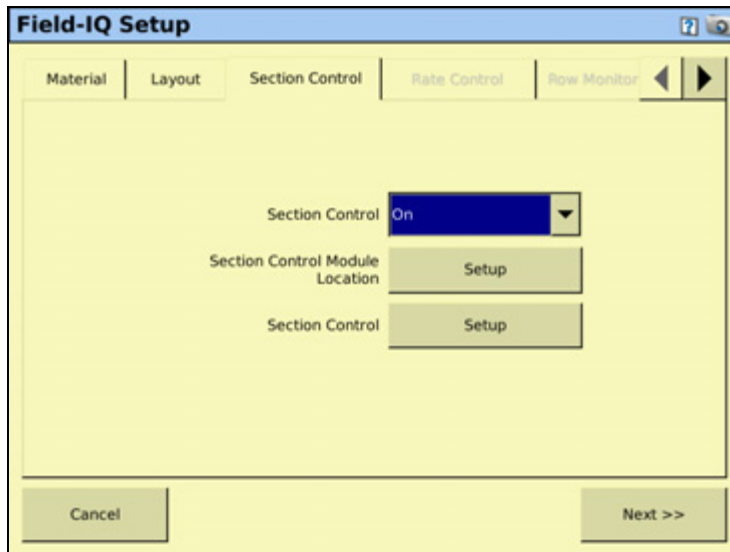

Setting	Description
Section Control	<p>On: Enable section control for the current material.</p> <p>Off: Disable section control for the current material.</p> <p>Rate as Section: When a rate controller turns on or off, the section turns on or off.</p> <p>Link to Material: See <a href="#">Linking materials</a>, page 261.</p>

Setting	Description
Section Control Module Setup	<p>Tap <b>Setup</b> to configure the section control module(s), their location on the implement, and the number of sections they will control.</p> <p>Assign the Field-IQ module to the correct location to ensure it controls the correct section.</p> <ul style="list-style-type: none"> <li>• Number of Modules: Enter the number of Field-IQ section control modules you will use.</li> <li>• Module: Select the module number that corresponds to each section.</li> <li>• Number of Sections: Assign the number of sections that each module will control.</li> <li>• Section Grouping: Assign the rows that are in each section.</li> <li>• Advanced Wire Assignment: Every section is controlled by a specific wire on each Field-IQ module. Use this setting to specify which module each section is wired to.</li> </ul>
Section Control	<p>Tap <b>Setup</b> to adjust settings for each section control module.</p> <ul style="list-style-type: none"> <li>• Section Control Type: Select the type of section control for each module.</li> <li>• Off When Stopped: When set to Yes the control valve will close when ground speed reaches 0 with the master switch position in On. When set to No the control valve will hold its last position when the master switch is shut off and ground speed reaches 0—if the vehicle is a clutch-operated planter, set this option to No so that you can continue planting when the vehicle is stopped. Otherwise, select Yes.</li> <li>• On Latency: By default, this is set to 0.0 seconds. Use this setting unless you are experiencing a long response time from your clutch or valve (this can happen on larger systems). In this case, increase the On Latency value to compensate the delay, and the system will turn on in advance.</li> <li>• Off Latency: By default, this is set to 0.0 seconds. Use this setting unless you are experiencing a long response time from your clutch or valve (this can happen on larger systems). In this case, increase the Off Latency value to compensate for the delay, and the system will turn off after the set number of seconds.</li> <li>• Start Overlap: Enter the distance of intentional swath overlap when entering a previously applied area. The higher the number, the greater the overlapped area.</li> <li>• End Overlap: Enter the distance of intentional swath overlap when exiting a previously applied area. The higher the number, the greater the overlapped area.</li> <li>• Coverage Switching Overlap: Enter the percentage of the section width for intentional swath overlap. The higher the number, the greater the overlapped area before the section is turned off.</li> <li>• Boundary Switching Overlap: Enter the percentage of the section width for intentional overlap of a boundary. The higher the number, the greater the overlapped area into the boundary area.</li> </ul>

## Rate Control tab

Adjust the rate control settings.

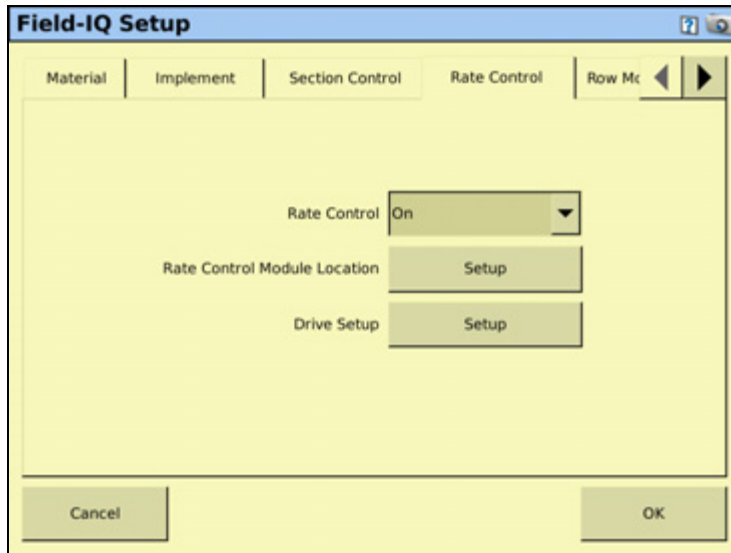

Setting	Description
Rate Control	On: The system sets the target rate. Off: Section switching only
Rate Control Module Location	Tap <b>Setup</b> to configure the rate control module(s), their location on the implement, and the width they will control.
Drive Setup	When you tap <b>Drive Setup</b> , a screen appears with the following tabs: <ul style="list-style-type: none"> <li>• Valve Setup</li> <li>• Feedback Setup</li> <li>• Advanced</li> </ul> The tabs are explained in more detail on the following pages.



## Drive Setup

### Valve Setup tab

**Rate and Section Controller Valve Calibration**

Valve | Control

Valve Type: PWM

Plumbing: inline

Valve Behavior On Sections Closed: Close

Auxiliary Valve: Dump

Pump Disarming Switch: Disabled

Cancel OK

Setting	Description
Valve Type	Servo: 2-wire standard servo valve Fast Servo: 4-wire servo valve PWM: 2-wire PWM valve (commonly used to control hydraulic flow).
Plumbing	Inline: Valve is in the solution line going to the boom. The valve opens to increase the application rate. Bypass: Valve is in the return-to-tank line. The valve closes to increase the application rate.
Valve Behavior On Sections Closed	Close: When all sections are off, the control valve returns to the closed position. Lock in Last Position: When all sections are off, the control valve remains in the last position. This setting allows the system to return to the target rate faster.
Auxiliary Valve	Master: Valve closes when the system is turned off. Dump: Valve opens to dump flow-to-return line when the system is turned off.
Pump Disarming Switch	Enable: Select this option if you have a pump disarming switch installed. Disable: Select this option if you do not have a pump disarming switch installed.

### Feedback Setup tab

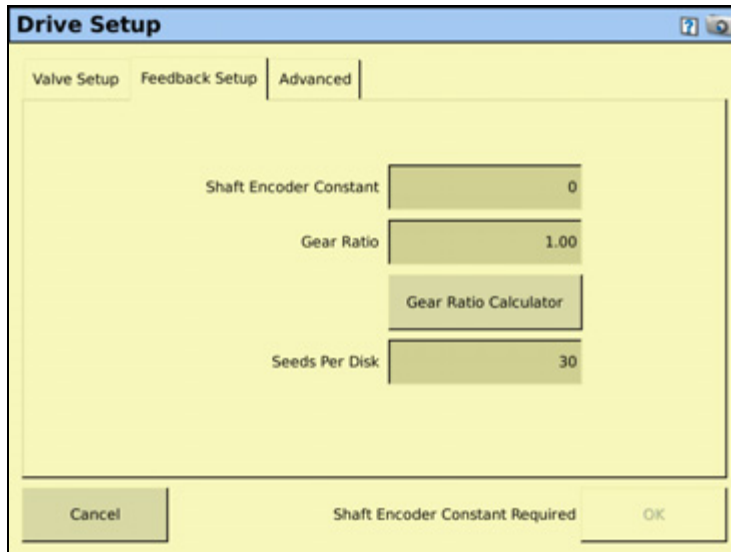

Setting	Description
Shaft Encoder Constant	Pulses per revolution.
Gear Ratio	Specifies the actual ratio from the application rate sensor to the seed meter shaft RPM. This is the number of revolutions the application rate sensor turns for each revolution of the seed meter.
Gear Ratio Calculator	Use the calculator to determine your gear ratio.
Seeds Per Disk	The number of seed openings per disk plate.

## Row Monitoring tab

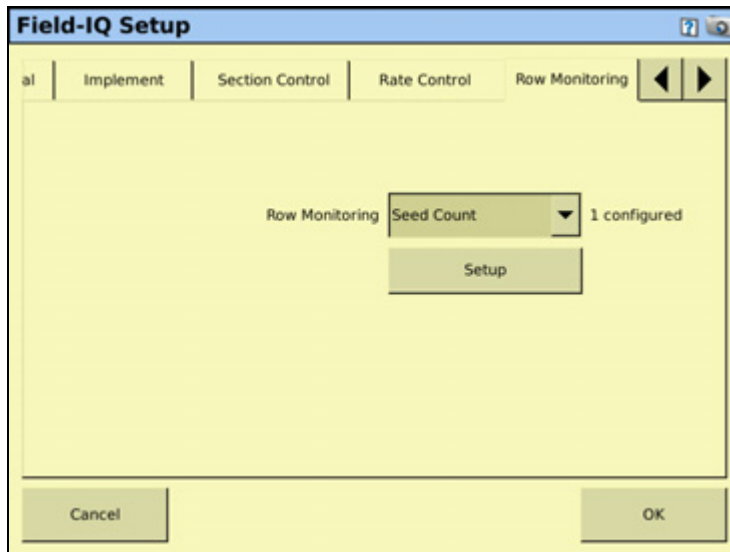

Setting	Description
Row Monitoring	Disabled: Row monitoring is turned off. Blockage: Select this option when using an air seeder or when applying granular material. Seed Count: Select this option for precision seeding.
Setup	Row Sensor Enable: Turn individual row sensors on or off. Row Sensor Wiring: Select which wire each row sensor is wired to.

## Sensors tab

Add or edit sensor settings.

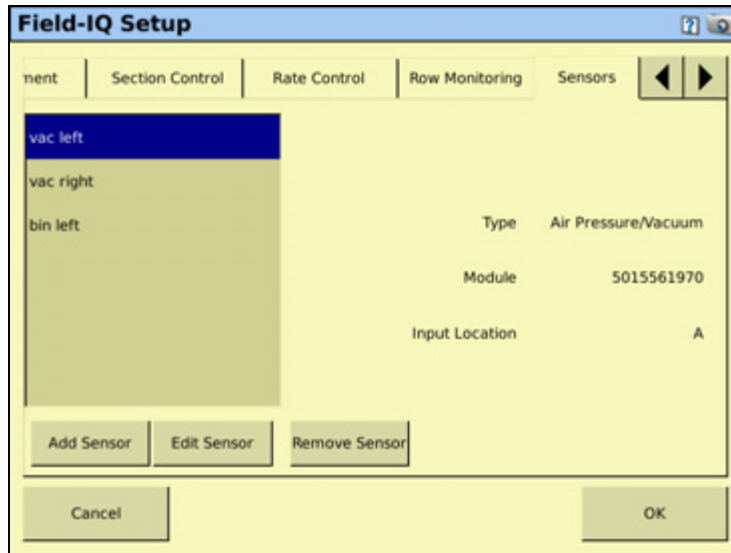

Setting	Description
Add Sensor	Add a new sensor.
Edit Sensor	Edit or view the settings for an existing sensor.
Remove Sensor	Delete an existing sensor.

When adding or editing a sensor, enter the following information:

Setting	Description
Sensor Type	Select from: <ul style="list-style-type: none"> <li>• Air pressure/vacuum</li> <li>• Liquid pressure</li> <li>• NH3 pressure</li> <li>• Bin level</li> <li>• RPM</li> <li>• Gate Height</li> </ul>
Name	Use the virtual keyboard to enter a name for the sensor.
Sensor Setup	Field-IQ module: Select the Field-IQ module that is controlling this sensor. Input location: Specify which wire is controlling the sensor.

## Operation tab

Setting	
Jump Start Speed	This setting controls the speed to be used when the Field-IQ master switchbox Master switch is put in the jump start position. This manual override option can be used to operate the system when the vehicle is stationary. Jump start is also used when GPS has become unavailable.
Shutoff Speed	This setting controls when to shut the system down if the implement drops below the specified speed.
Minimum Override Speed	This setting maintains the application rate when the implement's actual speed drops below the value entered. It is used to ensure consistent material flow during slow speeds.
When Outside Field Boundary	Switch off: The system will not apply outside the boundary area. Operate: The system will take into account latency settings when entering the boundary or exclusion zones.
Material Controlled By	Enabled: The material is tied to the Master Switch Box and cannot be controlled individually. Disabled: The Material is not tied to the Master Switch box and is controlled by virtual buttons on the Run screen.
Rate Snapping	Enabled: Shows the applied rate the same as the target rate, if the applied rate is within 10% of the target rate. Disabled: Shows the actual applied value.

## Material Setup Complete screen

When you have completed setting up a new material, the *Material Setup Complete* screen appears. You can select:

- **Add another material:** You are returned to the start of the *Field-IQ Setup Wizard*.
- **Finish Setup:** You are returned to the *Material Overview* screen.

### Calibrating the implement lift switch

1. From the *Field-IQ Calibration* screen, select the Implement Lift option.
2. Raise the implement and then tap **Next**.
3. Lower the implement and then tap **Next**.
4. Tap **OK** to return to the *Field-IQ Calibration* screen.

### Calibrating the Rawson modules

Calibrate the modules to ensure that your system performs at the level you require.

The *Field-IQ Calibrate* option only appears on the *Configuration* screen if you have at least one Field-IQ Rawson control module or Rate control module set up to control the rate.

1. From the *Configuration* screen, select the Field-IQ plugin and then tap **Calibrate**.
2. From the *Field-IQ Calibration* screen, select the module that you want to calibrate.

*Note* – If you have an implement lift switch, calibrate it first. See above.

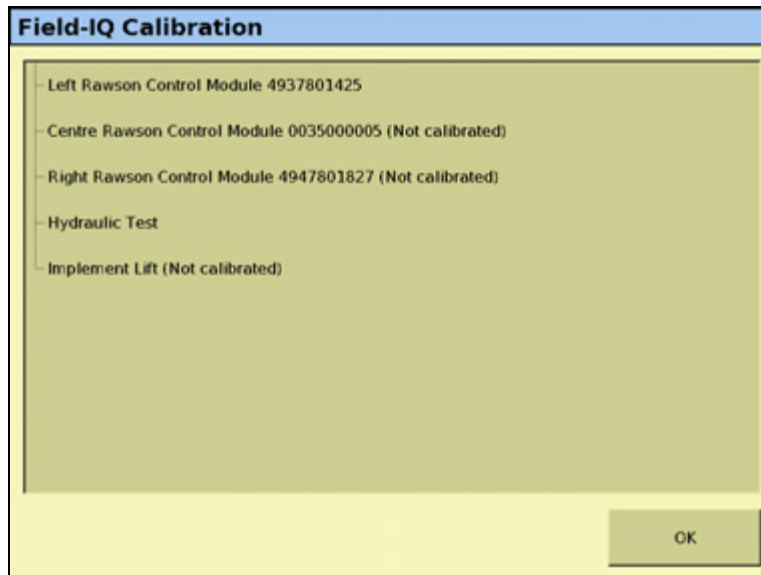

3. Select the first module to calibrate. The *Planter Calibration* screen appears:

*Note – If a Rawson module was configured, the correct calibration is selected automatically.*

Setting	Description
Seeds Per Disk	The number of seed openings per disk plate.
Gear Ratio	Specifies the actual ratio from the applicaiton rate sensor to the seed meter shaft RPM. This is the number of revolutions the application rate sensor turns for each revolution of the seed meter.
Gear Ratio Calculator	Use the calculator to determine your gear ratio.
Calibration Constant	A calculated value that the system determines during calibration. This field allows you to adjust for inconsistencies in the seed meters. To start out, leave the value at 1.000. After the calibration test, the system may adjust this number.

4. Place a clean empty container under the rows that contain seeds to capture the seeds dispensed during the calibration.



**CAUTION** – Moving parts during this operation. Ensure the implement is safe to operate.

5. Tap **Test**:
  - a. The system asks if you would like to prime the system. Tap **Yes**. To ensure that the seed disk is full, the system turns the seed disks one revolution.
  - b. Turn on the master switch to prime the system and then when prompted on-screen, turn off the master switch.
  - c. In the *Number of Seed Meter Revolutions*, enter a value and then tap **Start**. The higher the number of revolutions the more accurate the calibration. Five to 10 revolutions is recommended.

- d. Follow the on-screen prompts of operating the master switch. After the system turns the specified number of revolutions, enter the number of seeds dispensed per row and then tap **Continue**.
  - e. The next screen shows the minimum and maximum speeds for the target rate specified. Tap **OK** and then either press **Test** to repeat the calibration or tap **OK** to continue.
6. Select the *Limits* tab to show an overview of the limits that are set:

Speed Limits	Rate	Min Speed	Max Speed
Target Rate 1	30.00 kS/a	2.99 mph	8.96 mph
Target Rate 2	24.00 kS/a	3.73 mph	11.20 mph

Jump Start	Speed	Min Rate	Max Rate
	6.00 mph	14.93 kS/a	44.78 kS/a

7. Tap **OK**.
8. Repeat Step 1 through Step 7 for other Rawson Control Modules that need calibration.

### Hydraulic test

The purpose of this test is to exercise the hydraulics to establish whether there is sufficient oil flow to run the system.

1. From the Field-IQ *Calibration* screen tap **Hydraulic Test**.



**CAUTION** – Moving parts during this operation. Ensure the implement is safe to operate.

2. Tap **Next**.
3. Enter the initial motor RPM. The default setting is 300. Trimble also recommends that you test the motor RPM at 100 to ensure that the drive runs smoothly at slow speeds.
4. Tap **Start**.



- The next screen provides the status of each motor:

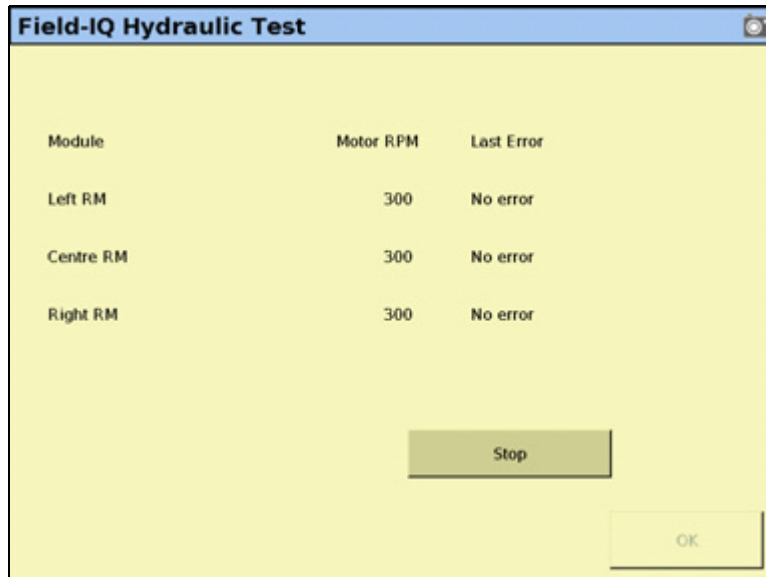

The screenshot shows a window titled "Field-IQ Hydraulic Test" with a yellow background. It contains a table with three columns: "Module", "Motor RPM", and "Last Error". The table lists three motor modules: "Left RM", "Centre RM", and "Right RM", each with a "Motor RPM" of 300 and a "Last Error" of "No error". Below the table are two buttons: "Stop" and "OK".

Module	Motor RPM	Last Error
Left RM	300	No error
Centre RM	300	No error
Right RM	300	No error

**No Error:** The test was successful.

**Motor Stalled:** The motors did not have sufficient oil flow; ensure the correct orifice size is installed for each motor. For more information, refer to the *Rawson System Installation Instructions*.

**Disconnected:** The Rawson Control Module cannot communicate with the motor.

- Tap **Stop** to return to the Field-IQ *Calibration* screen.

## Calibrating the PWM valves

### Drive Calibration

From the *Field-IQ Calibration* screen, select *Drive Calibration*. The *Field-IQ Drive Calibration* screen has four tabs:

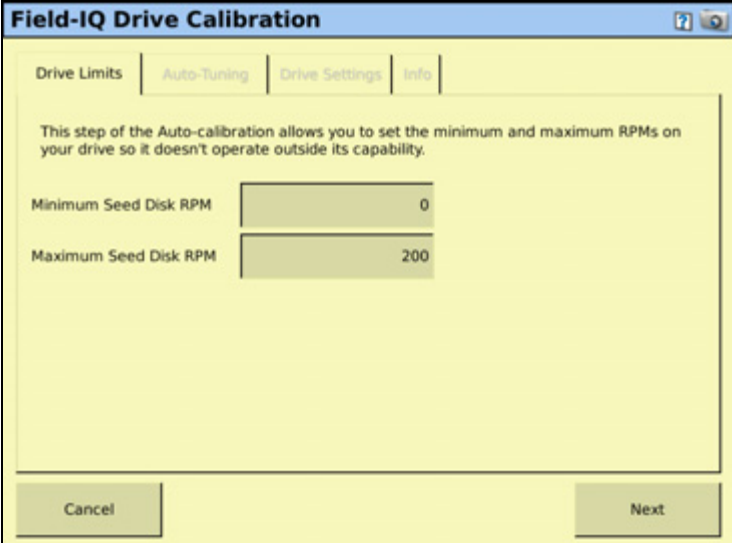
Tab	Description
Drive Limits	<p>Enter the minimum and maximum flow values:</p> 

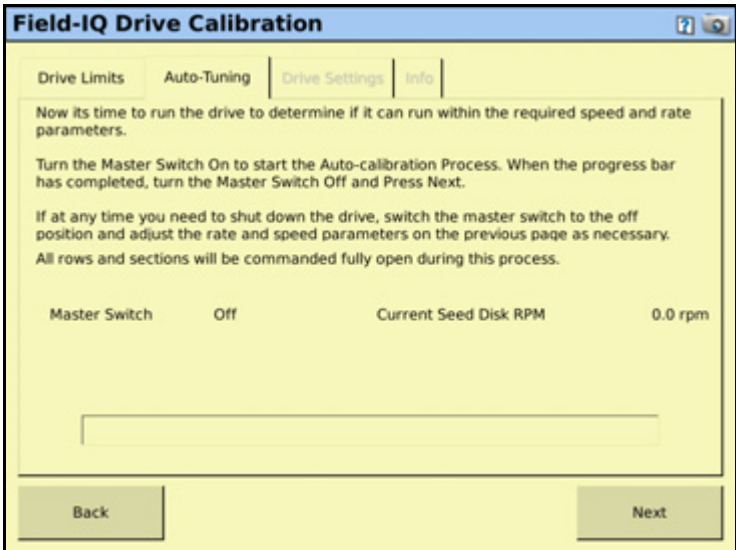
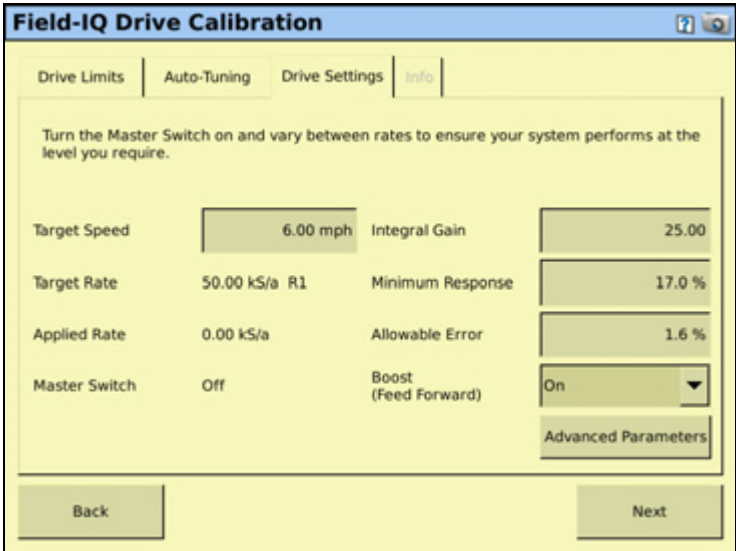
Tab	Description
Auto-Tuning	<div data-bbox="511 310 1360 388">  <b>WARNING</b> – Moving parts during this operation. Ensure that the implement is safe to operate.                 </div> <p data-bbox="511 405 1125 434">Follow the on-screen instructions to auto-tune the system:</p> <div data-bbox="511 457 1242 1003">  </div> <p data-bbox="511 1016 1325 1100"><b>Note</b> – Do not perform the auto-tuning function if you have loaded a preset configuration file. Use the predefined configuration settings appropriate for your vehicle.</p>
Drive Settings	<p data-bbox="511 1113 1247 1142">Turn the master switch on and vary the rates. Adjust values if needed:</p> <div data-bbox="511 1165 1242 1711">  </div>
Info	Shows the results and drive limits of your calibration.

## Flow Calibration

From the *Field-IQ Calibration* screen, select *Flow Calibration* under the valve you want to calibrate. The *Planter Calibration* screen appears:

1. In the *Calibrate* tab, enter the following:

Setting	Description
Seeds Per Disk	The number of seed openings per disk plate.
Shaft Encoder Constant	Pulses per revolution.
Calibration Constant	A calculated value that the system determines during calibration. This field allows you to adjust for inconsistencies in the seed meters. To start out, leave the value at 1.000. After the calibration test, the system may adjust this number.
Test	Follow the on-screen instructions to test the settings you entered.

2. Select the *Limits* tab to show an overview of the limits that are set:

**Planter Calibration**

Rate Controller: 4937801425

Calibrate Limits

Speed Limits	Rate	Min Speed	Max Speed
Target Rate 1	30.00 kS/a	2.99 mph	8.96 mph
Target Rate 2	24.00 kS/a	3.73 mph	11.20 mph

Jump Start	Speed	Min Rate	Max Rate
	6.00 mph	14.93 kS/a	44.78 kS/a

Cancel OK

## Operating in the field

1. From the Home screen, tap .
2. From the *Current Configurations* screen, configure the display/vehicle/ implement settings and then tap **OK**.
3. From the *Field Selection* screen, select the required client/farm/field/event settings and then tap **OK**.

## Setting up the Field-IQ system for Air Seeding

Make sure that you have set your implement to Seeder, and that you have configured the implement, see [Configuring the display, page 73](#). In the *Material Overview* screen, tap **New** to open the Field-IQ Setup Wizard. The Wizard contains the following seven tabs:

For information on this tab...	See...
Material	<a href="#">page 282</a>
Layout	<a href="#">page 284</a>
Section Control	<a href="#">page 285</a>
Rate Control	<a href="#">page 287</a>
Row Monitoring	<a href="#">page 290</a>
Sensors	<a href="#">page 291</a>
Operation	<a href="#">page 292</a>

## Material tab

Enter information about the material you want to set up.

Setting	Description
Material Type	Select your Field-IQ application type: <b>Note</b> – <i>If spraying chemicals, use the liquid fertilizer setting.</i> <ul style="list-style-type: none"> <li>• Row Crop Seed</li> <li>• Liquid</li> <li>• Granular Seed</li> <li>• Granular Fertilizer</li> <li>• Anhydrous</li> </ul>
Material Name	Use the virtual keyboard to enter a name for the material.
Material Details	Tap <b>Setup</b> to open the <i>Hybrid Setup</i> screen. See <a href="#">Logging varieties, page 65</a> .

Setting	Description
Application Rate	<p><b>Rates tab</b></p> <p>Adjust the following Rate settings:</p> <ul style="list-style-type: none"> <li>• Target Rate: This setting controls the volume that the implement supplies when the Rate switch is in position 1.</li> <li>• Target Rate 2: This setting controls the volume that the implement supplies when the Rate switch is in position 2.</li> <li>• Rate Increment: When the Rate switch is in the Rate 1 or Rate 2 position, the current application rate increases or decreases by this amount each time you press the Rate adjustment (increment/decrement) switch on your master switch box.</li> <li>• Manual Rate Increment: When the Rate switch is in the Manual position, the current application rate increases or decreases by this amount each time you press the Rate adjustment (increment/decrement) switch on your master switch box.</li> <li>• Minimum Rate: This setting is the minimum rate that will be applied.</li> <li>• Maximum Rate: This setting is the maximum rate that will be applied</li> </ul> <p><b>Units tab</b></p> <p>Adjust the following Unit settings:</p> <ul style="list-style-type: none"> <li>• Seeds Per Pound: Enter the number of seeds per pound of the current material.</li> <li>• Target Rate Units: Choose what units your target rate will apply.</li> <li>• Bushel Weight: Enter the bushel weight of the current material.</li> </ul>
Rate Alarms	<p>Tap <b>Setup</b> to set alarm thresholds and adjust the way seed statistics are calculated:</p> <ul style="list-style-type: none"> <li>• Blockage Sensitivity/Alarm: When less than this amount of material is sensed for the number of seconds given.</li> </ul>

## Layout tab

Enter information about the implement that will be used to apply the material.

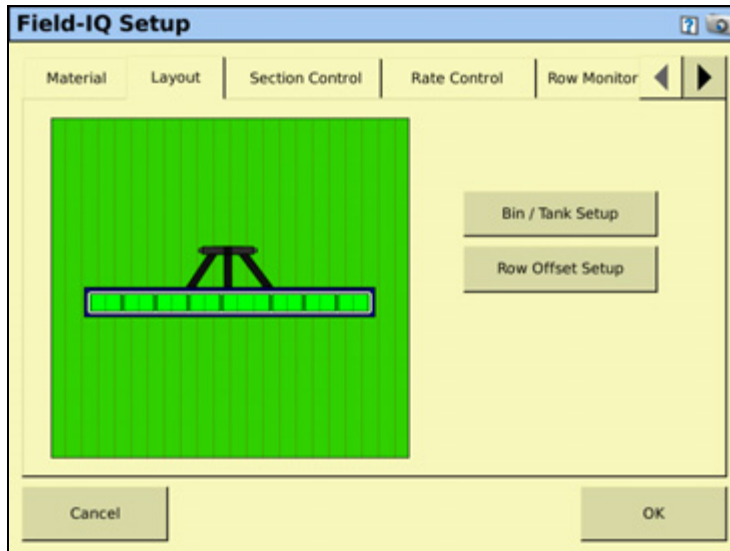

Setting	Description
Bin/Tank Setup	<p>Allows the system to track how much material is left in the bin/tank, and provides a warning when the bin/tank needs to be refilled. Adjust the settings for:</p> <ul style="list-style-type: none"> <li>• Status: <ul style="list-style-type: none"> <li>On: The system will track the bin/tank level and provide warnings.</li> <li>Off: The system will not track the bin/tank level or provide warnings.</li> </ul> </li> <li>• Capacity Units: Select Default Units or Bushels. Default units will vary according to the type of material that is being applied.</li> <li>• Bin Capacity: The amount the tank/bin holds when full.</li> </ul> <p><b>Note</b> – <i>Markings on tank/bin may not be accurate.</i></p> <ul style="list-style-type: none"> <li>• Current Volume: Current volume of the product in the tank.</li> <li>• Partial Refill: The amount of material that will be added to the bin/tank during a partial refill.</li> <li>• Warning Level: A warning will appear on your screen when your bin/tank reaches a set threshold.</li> <li>• Refill Tank/Bin: Refills the tank/bin to capacity.</li> <li>• Partial Refill Tank/Bin: Refills the tank/bin to the amount specified in the <i>Partial Refill</i> field.</li> </ul>



Setting	Description
Row Offset Setup	<p>Row Offset Setup provides additional tuning by detailing where the material will be applied in relation to the vehicle. Increase coverage accuracy by selecting one or two offsets.</p> <p>Row offsets are measured from the Application Offset that is entered in the Measurements tab of the Implement Configuration wizard. See <a href="#">Implement Configuration, Measurements</a>, page 165.</p> <ul style="list-style-type: none"> <li>Number of row offsets: Use 1 row offset when coverage is applied at a single location. Use two row offsets when planting singulated seed with staggered implements.</li> <li>Row Offset (1 row offset): Enter the distance between the Application Offset and the row.</li> <li>Rear Row Offset (2 row offset): Enter the distance between the Application Offset and the rear row.</li> <li>Front Row Offset (2 row offset): Enter the distance between the Application Offset and the front row.</li> </ul>

## Section Control tab

Adjust the section control settings.

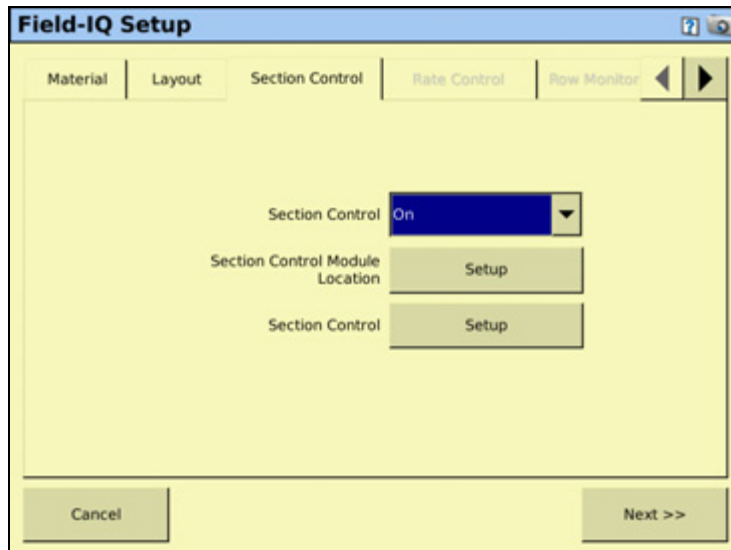

Setting	Description
Section Control	<p>On: Enable section control for the current material.</p> <p>Off: Disable section control for the current material.</p> <p>Rate as Section: When a rate controller turns on or off, the section turns on or off.</p> <p>Link to Material: See <a href="#">Linking materials</a>, page 261.</p>

Setting	Description
Section Control Module Setup	<p>Tap <b>Setup</b> to configure the section control module(s), their location on the implement, and the number of sections they will control.</p> <p>Assign the Field-IQ module to the correct location to ensure it controls the correct section.</p> <ul style="list-style-type: none"> <li>• Number of Modules: Enter the number of Field-IQ section control modules you will use.</li> <li>• Module: Select the module number that corresponds to each section.</li> <li>• Number of Sections: Assign the number of sections that each module will control.</li> <li>• Section Grouping: Assign the rows that are in each section.</li> <li>• Advanced Wire Assignment: Every section is controlled by a specific wire on each Field-IQ module. Use this setting to specify which module each section is wired to.</li> </ul>
Section Control	<p>Tap <b>Setup</b> to adjust settings for each section control module.</p> <ul style="list-style-type: none"> <li>• Section Control Type: Select the type of section control for each module.</li> <li>• Off When Stopped: When set to Yes the control valve will close when ground speed reaches 0 with the master switch position in On. When set to No the control valve will hold its last position when the master switch is shut off and ground speed reaches 0—if the vehicle is a clutch-operated planter, set this option to No so that you can continue planting when the vehicle is stopped. Otherwise, select Yes.</li> <li>• On Latency: By default, this is set to 0.0 seconds. Use this setting unless you are experiencing a long response time from your clutch or valve (this can happen on larger systems). In this case, increase the On Latency value to compensate the delay, and the system will turn on in advance.</li> <li>• Off Latency: By default, this is set to 0.0 seconds. Use this setting unless you are experiencing a long response time from your clutch or valve (this can happen on larger systems). In this case, increase the Off Latency value to compensate for the delay, and the system will turn off after the set number of seconds.</li> <li>• Start Overlap: Enter the distance of intentional swath overlap when entering a previously applied area. The higher the number, the greater the overlapped area.</li> <li>• End Overlap: Enter the distance of intentional swath overlap when exiting a previously applied area. The higher the number, the greater the overlapped area.</li> <li>• Coverage Switching Overlap: Enter the percentage of the section width for intentional swath overlap. The higher the number, the greater the overlapped area before the section is turned off.</li> <li>• Boundary Switching Overlap: Enter the percentage of the section width for intentional overlap of a boundary. The higher the number, the greater the overlapped area into the boundary area.</li> </ul>

## Rate Control tab

Adjust the rate control settings.

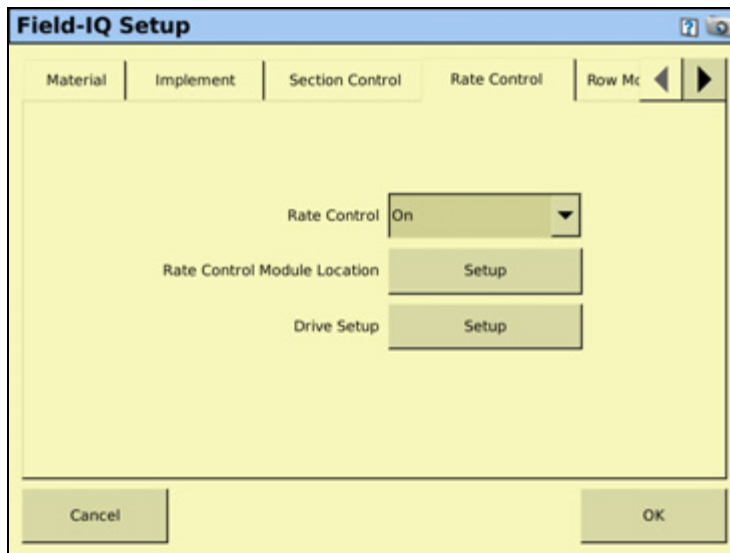

Setting	Description
Rate Control	On: The system sets the target rate. Off: Section switching only
Rate Control Module Location	Tap <b>Setup</b> to configure the rate control module(s), their location on the implement, and the width they will control.
Drive Setup	When you tap <b>Drive Setup</b> , a screen appears with the following tabs: <ul style="list-style-type: none"> <li>Valve Setup</li> <li>Feedback Setup</li> </ul> The tabs are explained in more detail on the following pages.

## Drive Setup

### Valve Setup tab

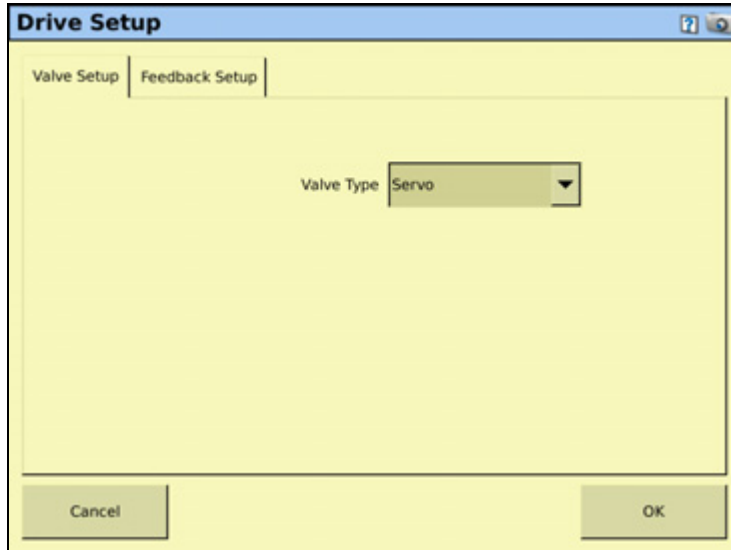

Setting	Description
Valve Type	<p>Servo: 2-wire standard servo valve</p> <p>Fast Servo: 4-wire servo valve</p> <p>PWM: 2-wire PWM valve (commonly used to control hydraulic flow to the pump)</p> <p>Pump Servo: Servo valve (commonly used to control hydraulic flow to the pump).</p> <p>Linear Actuator: A valve that creates a linear motion (as opposed to a rotary motion).</p> <p>Electric over Hydraulic: A valve that uses electric current to control the hydraulic valve output.</p>

## Feedback Setup tab

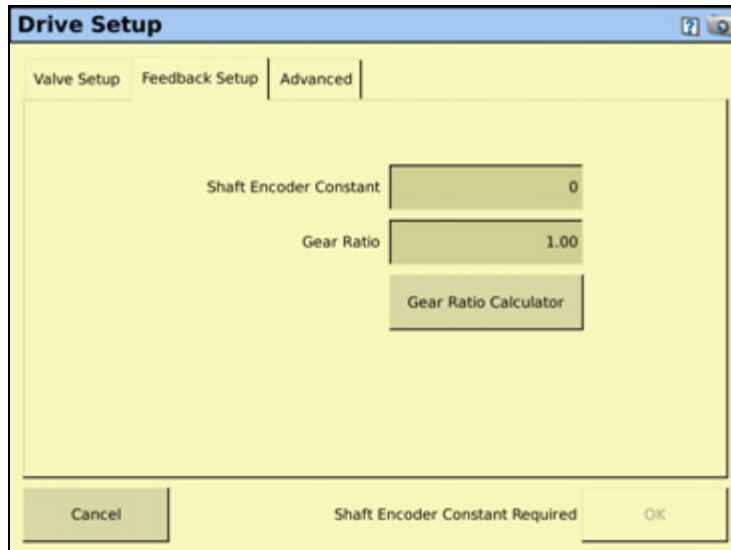

Setting	Description
Shaft Encoder Constant	Pulses per revolution.
Gear Ratio	Specifies the actual ratio from the application rate sensor to the seed meter shaft RPM. This is the number of revolutions the application rate sensor turns for each revolution of the seed meter.
Gear Ratiion Constant	Use the calculator to determine your gear ratio.

## Row Monitoring tab

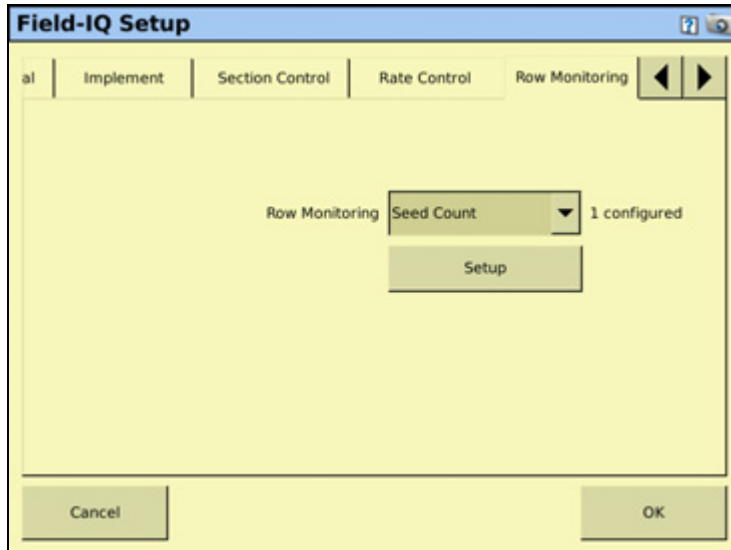

Setting	Description
Row Monitoring	Disabled: Turn row monitoring off. Blockage: Select this option for air seeding or when applying granular material.
Setup	Row Sensor Enable: Turn individual row sensors on or off. Row Sensor Wiring: Select which wire each row sensor is wired to.

## Sensors tab

Add or edit sensor settings.

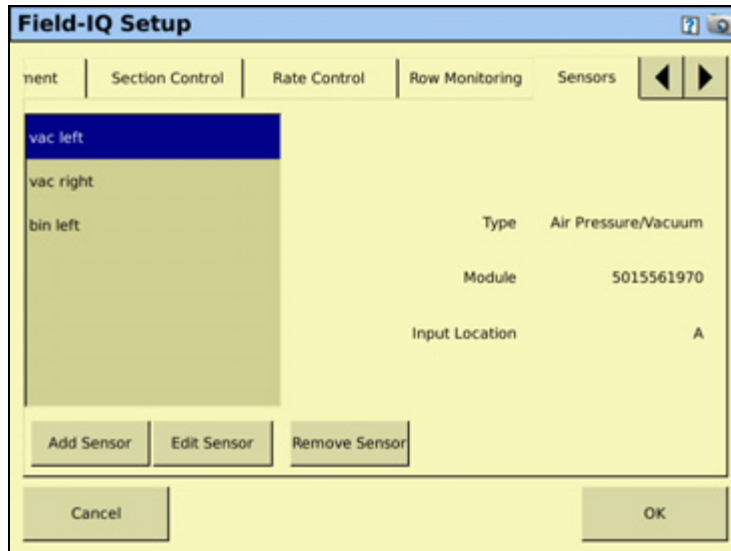

Setting	Description
Add Sensor	Add a new sensor.
Edit Sensor	Edit or view the settings for an existing sensor.
Remove Sensor	Delete an existing sensor.

When adding or editing a sensor, enter the following information:

Setting	Description
Sensor Type	Select from: <ul style="list-style-type: none"> <li>• Air pressure/vacuum</li> <li>• Liquid pressure</li> <li>• NH3 pressure</li> <li>• Bin level</li> <li>• RPM</li> <li>• Gate Height</li> </ul>
Name	Use the virtual keyboard to enter a name for the sensor.
Sensor Setup	Field-IQ module: Select the Field-IQ module that is controlling this sensor. Input location: Specify which wire is controlling the sensor.

## Operation tab

Setting	
Jump Start Speed	This setting controls the speed to be used when the Field-IQ master switchbox Master switch is put in the jump start position. This manual override option can be used to operate the system when the vehicle is stationary. Jump start is also used when GPS has become unavailable.
Shutoff Speed	This setting controls when to shut the system down if the implement drops below the specified speed.
Minimum Override Speed	This setting maintains the application rate when the implement's actual speed drops below the value entered. It is used to ensure consistent material flow during slow speeds.
When Outside Field Boundary	Switch off: The system will not apply outside the boundary area. Operate: The system will apply outside the boundary area.
Material Controlled By	Enabled: The material is tied to the Master Switch Box and cannot be controlled individually. Disabled: The Material is not tied to the Master Switch box and is controlled by virtual buttons on the Run screen.
Rate Snapping	Enabled: Shows the applied rate the same as the target rate, if the applied rate is within 10% of the target rate. Disabled: Shows the actual applied value.

## Material Setup Complete screen

When you have completed setting up a new material, the *Material Setup Complete* screen appears. You can select:

- **Add another material.** You are returned to the start of the *Field-IQ Setup Wizard*.
- **Finish Setup.** You are returned to the *Material Overview* screen.



## Calibrating the implement lift switch

1. From the *Field-IQ Calibration* screen, select the Implement Lift option.
2. Raise the implement and then tap **Next**.
3. Lower the implement and then tap **Next**.
4. Tap **OK** to return to the *Field-IQ Calibration* screen.

## Calibrating the modules

Calibrate the modules to ensure that your system performs at the level you require.

The *Field-IQ Calibrate* option only appears on the *Configuration* screen if you have at least one *Field-IQ Rawson control module* or *Rate control module* set up to control the rate.

1. From the *Configuration* screen, select the *Field-IQ plugin* and then tap **Calibrate**.
2. From the *Field-IQ Calibration* screen, select the operation under the *Module* that you would like to calibrate. The message **Not calibrated** appears at the end of the modules that need calibration.

**Note** – *Calibration screens will vary slightly if you are using a linear actuator.*

**Note** – *Before priming the system, the Automatic / Manual Switch on the master switch box must be in the manual position.*

**Note** – *If you have an impelement lift switch, calibrate it first. See above.*

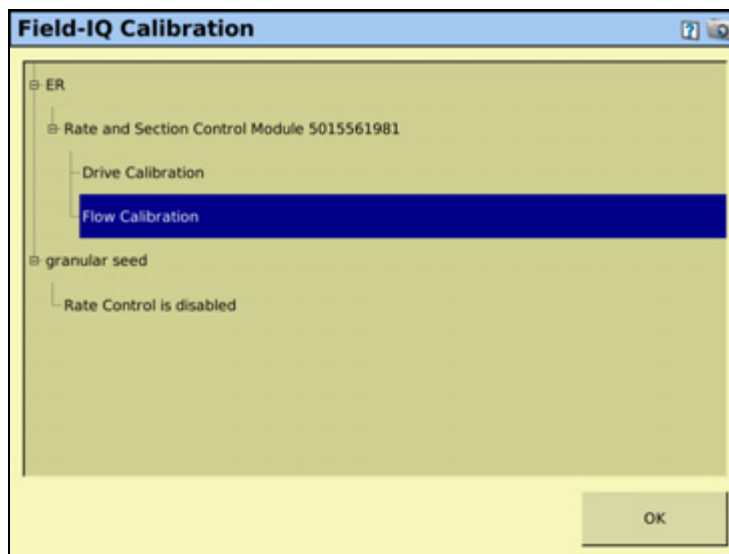

3. Select *Drive Calibration* and then tap **OK**. The *Drive Calibration* screen appears—this screen has four tabs:

Tab	Description
Drive Limits	Enter the minimum and maximum flow values.
Auto-Tuning	 <p><b>WARNING</b> – Moving parts during this operation. Ensure that the implement is safe to operate.</p> <hr/> <p>Follow the on-screen instructions to auto-tune the system.</p> <p><b>Note</b> – Do not perform the auto-tuning function if you have loaded a preset configuration file. Use the predefined configuration settings appropriate for your vehicle.</p>
Drive Settings	Turn the master switch on and vary the rates. Adjust values if needed.
Info	Shows the results and drive limits of your calibration.

4. Select *Flow Calibration* and then tap **OK**. The *Flow Calibration* screen appears.

## Operating in the field

1. From the Home screen, tap .
2. From the *Current Configurations* screen, configure the display/vehicle/ implement settings and then tap **OK**.
3. From the *Field Selection* screen, select the required client/farm/field/event settings and then tap **OK**.

## Setting up the Field-IQ system for Spraying

Make sure that you have set your implement to Sprayer, and that you have configured the implement, see [Configuring the display, page 73](#). In the *Material Overview* screen, tap **New** to open the Field-IQ Setup Wizard. The Wizard contains the following seven tabs:

For information on this tab...	See...
Material	<a href="#">page 295</a>
Layout	<a href="#">page 296</a>
Section Control	<a href="#">page 297</a>
Rate Control	<a href="#">page 299</a>
Sensors	<a href="#">page 302</a>
Operation	<a href="#">page 303</a>

## Material tab

Enter information about the material you want to set up.

Setting	Description
Material Type	<p>Select your Field-IQ application type:</p> <p><b>Note</b> – <i>If spraying chemicals, use the liquid fertilizer setting.</i></p> <ul style="list-style-type: none"> <li>• Row Crop Seed</li> <li>• Liquid</li> <li>• Granular Seed</li> <li>• Granular Fertilizer</li> <li>• Anhydrous</li> </ul>
Material Name	Use the virtual keyboard to enter a name for the material.
Application Rate	<p><b>Rates tab</b></p> <p>Adjust the following Rate settings:</p> <ul style="list-style-type: none"> <li>• Target Rate: This setting controls the volume that the implement supplies when the Rate switch is in position 1.</li> <li>• Target Rate 2: This setting controls the volume that the implement supplies when the Rate switch is in position 2.</li> <li>• Rate Increment: When the Rate switch is in the Rate 1 or Rate 2 position, the current application rate increases or decreases by this amount each time you press the Rate adjustment (increment/decrement) switch on your master switch box.</li> <li>• Manual Rate Increment: When the Rate switch is in the Manual position, the current application rate increases or decreases by this amount each time you press the Rate adjustment (increment/decrement) switch on your master switch box.</li> <li>• Minimum Rate: This setting is the minimum rate that will be applied.</li> <li>• Maximum Rate: This setting is the maximum rate that will be applied</li> </ul> <p><b>Units tab</b></p> <p>Adjust the following Unit settings:</p> <ul style="list-style-type: none"> <li>• Seeds Per Pound: Enter the number of seeds per pound of the current material.</li> <li>• Target Rate Units: Choose what units your target rate will apply.</li> <li>• Bushel Weight: Enter the bushel weight of the current material.</li> </ul>

## Layout tab

Enter information about the implement that will be used to apply the material.

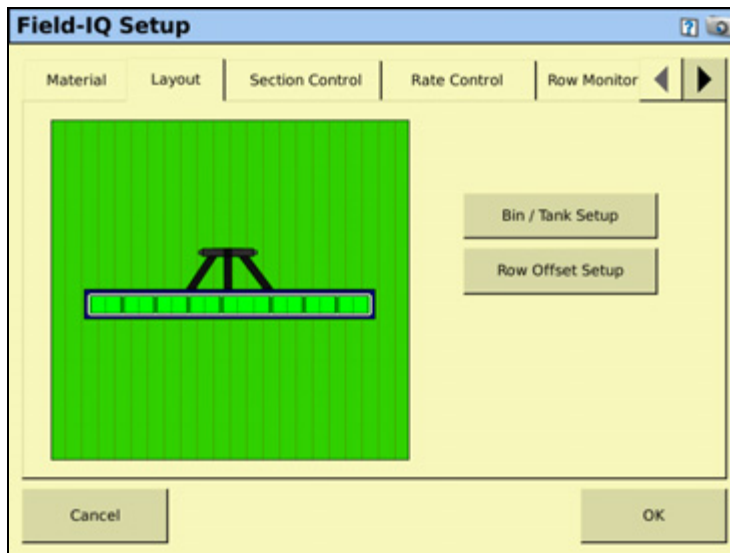

Setting	Description
Bin/Tank Setup	<p>Allows the system to track how much material is left in the bin/tank, and provides a warning when the bin/tank needs to be refilled. Adjust the settings for:</p> <ul style="list-style-type: none"> <li>• Status: <ul style="list-style-type: none"> <li>On: The system will track the bin/tank level and provide warnings.</li> <li>Off: The system will not track the bin/tank level or provide warnings.</li> </ul> </li> <li>• Capacity Units: Select Default Units or Bushels. Default units will vary according to the type of material that is being applied.</li> <li>• Bin Capacity: The amount the tank/bin holds when full.</li> </ul> <p><b>Note</b> – <i>Markings on tank/bin may not be accurate.</i></p> <ul style="list-style-type: none"> <li>• Current Volume: Current volume of the product in the tank.</li> <li>• Partial Refill: The amount of material that will be added to the bin/tank during a partial refill.</li> <li>• Warning Level: A warning will appear on your screen when your bin/tank reaches a set threshold.</li> <li>• Refill Tank/Bin: Refills the tank/bin to capacity.</li> <li>• Partial Refill Tank/Bin: Refills the tank/bin to the amount specified in the <i>Partial Refill</i> field.</li> </ul>

Setting	Description
Row Offset Setup	<p>Row Offset Setup provides additional tuning by detailing where the material will be applied in relation to the vehicle. Increase coverage accuracy by selecting one or two offsets.</p> <p>Row offsets are measured from the Application Offset that is entered in the Measurements tab of the Implement Configuration wizard. See <a href="#">Implement Configuration, Measurements</a>, page 165.</p> <ul style="list-style-type: none"> <li>Number of row offsets: Use 1 row offset when coverage is applied at a single location. Use two row offsets when planting singulated seed with staggered implements.</li> <li>Row Offset (1 row offset): Enter the distance between the Application Offset and the row.</li> <li>Rear Row Offset (2 row offset): Enter the distance between the Application Offset and the rear row.</li> <li>Front Row Offset (2 row offset): Enter the distance between the Application Offset and the front row.</li> </ul>

## Section Control tab

Adjust the section control settings.

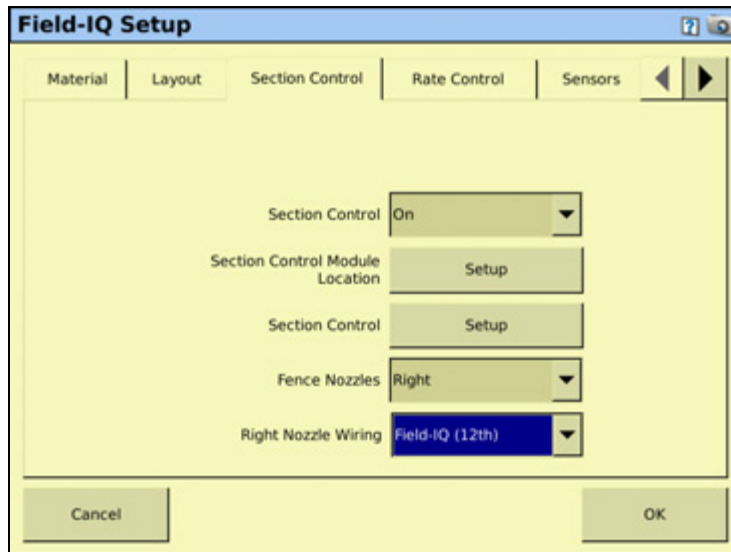

Setting	Description
Section Control	<p>On: Enable section control for the current material.</p> <p>Off: Disable section control for the current material.</p> <p>Rate as Section: When a rate controller turns on or off, the section turns on or off.</p> <p>Link to Material: See <a href="#">Linking materials</a>, page 261.</p>

Setting	Description
Section Control Module Setup	<p>Tap <b>Setup</b> to configure the section control module(s), their location on the implement, and the number of sections they will control.</p> <p>Assign the Field-IQ module to the correct location to ensure it controls the correct section.</p> <ul style="list-style-type: none"> <li>• Number of Modules: Enter the number of Field-IQ section control modules you will use.</li> <li>• Module: Select the module number that corresponds to each section.</li> <li>• Number of Sections: Assign the number of sections that each module will control.</li> <li>• Section Grouping: Assign the rows that are in each section.</li> <li>• Advanced Wire Assignment: Every section is controlled by a specific wire on each Field-IQ module. Use this setting to specify which module each section is wired to.</li> </ul>
Section Control	<p>Tap <b>Setup</b> to adjust settings for each section control module.</p> <ul style="list-style-type: none"> <li>• Section Control Type: Select the type of section control for each module.</li> <li>• Off When Stopped: When set to Yes the control valve will close when ground speed reaches 0 with the master switch position in On. When set to No the control valve will hold its last position when the master switch is shut off and ground speed reaches 0—if the vehicle is a clutch-operated planter, set this option to No so that you can continue planting when the vehicle is stopped. Otherwise, select Yes.</li> <li>• On Latency: By default, this is set to 0.0 seconds. Use this setting unless you are experiencing a long response time from your clutch or valve (this can happen on larger systems). In this case, increase the On Latency value to compensate the delay, and the system will turn on in advance.</li> <li>• Off Latency: By default, this is set to 0.0 seconds. Use this setting unless you are experiencing a long response time from your clutch or valve (this can happen on larger systems). In this case, increase the Off Latency value to compensate for the delay, and the system will turn off after the set number of seconds.</li> <li>• Start Overlap: Enter the distance of intentional swath overlap when entering a previously applied area. The higher the number, the greater the overlapped area.</li> <li>• End Overlap: Enter the distance of intentional swath overlap when exiting a previously applied area. The higher the number, the greater the overlapped area.</li> <li>• Coverage Switching Overlap: Enter the percentage of the section width for intentional swath overlap. The higher the number, the greater the overlapped area before the section is turned off.</li> <li>• Boundary Switching Overlap: Enter the percentage of the section width for intentional overlap of a boundary. The higher the number, the greater the overlapped area into the boundary area.</li> </ul>
Fence Nozzles	<p>Many setups require a left fence nozzle to be configured, even when there is no left fence nozzle. For more information, refer to your sprayer installation instructions.</p>
Right Nozzle Wiring	<p>In you are using an EZ-Boom replacement harness, select the EZ-Boom setting. Otherwise, select the Field-IQ setting.</p>

## Rate Control tab

Adjust the rate control settings.

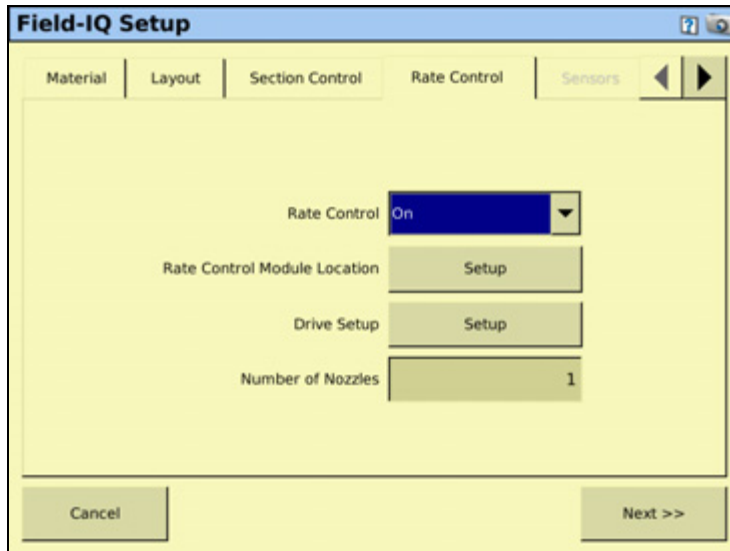

Setting	Description
Rate Control	On: The system sets the target rate. Off: Section switching only
Rate Control Module Location	Tap <b>Setup</b> to configure the rate control module(s), their location on the implement, and the width they will control.
Drive Setup	When you tap <b>Drive Setup</b> , a screen appears with the following tabs: <ul style="list-style-type: none"> <li>• Valve Setup</li> <li>• Feedback Setup</li> </ul> The tabs are explained in more detail on the following pages.
Number of Nozzles	Enter the number of spray nozzles on the sprayer.

## Drive Setup

### Valve Setup tab

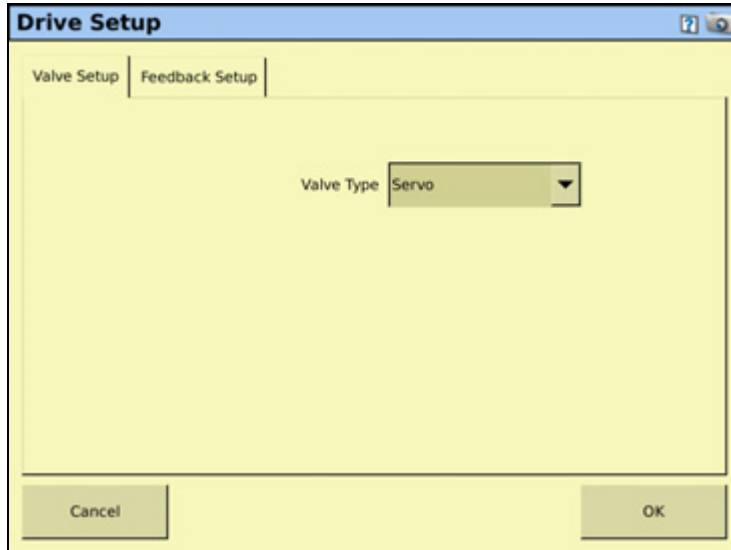

Setting	Description
Valve Type	<p>Servo: 2-wire standard servo valve</p> <p>Fast Servo: 4-wire servo valve</p> <p>PWM: 2-wire PWM valve (commonly used to control hydraulic flow to the pump)</p> <p>Hardi % Bypass: Used on Hardi sprayers equipped with 3-way section valves that return flow to the tank when the boom section is off.</p> <p>Pump Servo: Servo valve (commonly used to control hydraulic flow to the pump).</p> <p>Electric over Hydraulic: A valve that uses electric current to control the hydraulic valve output.</p>



## Feedback Setup tab

The screenshot shows a software dialog box titled "Drive Setup". It has two tabs: "Valve Setup" and "Feedback Setup". The "Feedback Setup" tab is selected. Inside the dialog, there are three configuration items:

- Flow Meter Type:** A dropdown menu currently showing "Raven".
- Flowmeter Calibration:** A text input field containing the value "360.00 pul/gal".
- Min Flow:** A text input field containing the value "10.0 lbs(N)/min".

At the bottom of the dialog, there are two buttons: "Cancel" on the left and "OK" on the right.

Setting	Description
Flow Meter Type	Select the type of flow meter that is connected.
Flowmeter Calibration	Enter the number from the flow meter tag.
Min Flow	Enter the required minimum flow rate for the system. Use this setting to keep the control valve and flow meter above the minimum operating level.

## Sensors tab

Add or edit sensor settings.

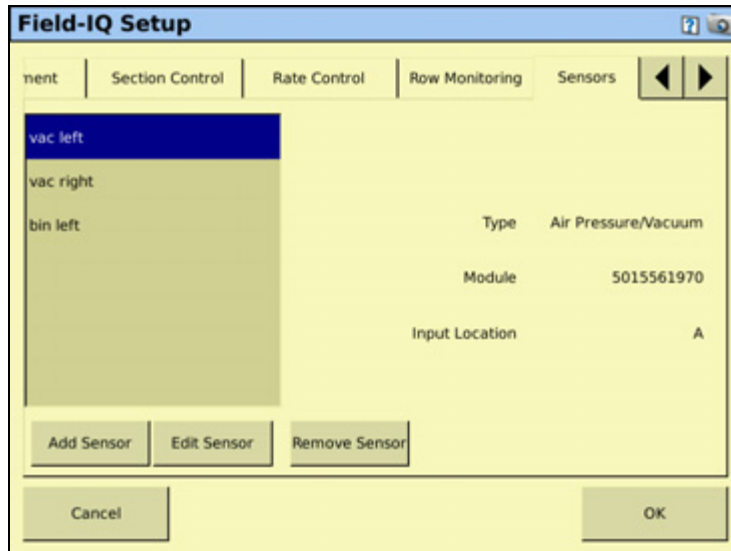

Setting	Description
Add Sensor	Add a new sensor.
Edit Sensor	Edit or view the settings for an existing sensor.
Remove Sensor	Delete an existing sensor.

When adding or editing a sensor, enter the following information:

Setting	Description
Sensor Type	Select from: <ul style="list-style-type: none"> <li>• Air pressure/vacuum</li> <li>• Liquid pressure</li> <li>• NH3 pressure</li> <li>• Bin level</li> <li>• RPM</li> <li>• Gate Height</li> </ul>
Name	Use the virtual keyboard to enter a name for the sensor.
Sensor Setup	Field-IQ module: Select the Field-IQ module that is controlling this sensor. Input location: Specify which wire is controlling the sensor.

## Operation tab

Setting	
Jump Start Speed	This setting controls the speed to be used when the Field-IQ master switchbox Master switch is put in the jump start position. This manual override option can be used to operate the system when the vehicle is stationary. Jump start is also used when GPS has become unavailable.
Shutoff Speed	This setting controls when to shut the system down if the implement drops below the specified speed.
Minimum Override Speed	This setting maintains the application rate when the implement's actual speed drops below the value entered. It is used to ensure consistent material flow during slow speeds.
When Outside Field Boundary	Switch off: The system will not apply outside the boundary area. Operate: The system will apply outside the boundary area.
Material Controlled By	Enabled: The material is tied to the Master Switch Box and cannot be controlled individually. Disabled: The Material is not tied to the Master Switch box and is controlled by virtual buttons on the Run screen.
Rate Snapping	Enabled: Shows the applied rate the same as the target rate, if the applied rate is within 10% of the target rate. Disabled: Shows the actual applied value.

## Material Setup Complete screen

When you have completed setting up a new material, the *Material Setup Complete* screen appears. You can select:

- **Add another material.** You are returned to the start of the *Field-IQ Setup Wizard*.
- **Finish Setup.** You are returned to the *Material Overview* screen.

## Calibrating the implement lift switch

1. From the *Field-IQ Calibration* screen, select the Implement Lift option.
2. Raise the implement and then tap **Next**.
3. Lower the implement and then tap **Next**.
4. Tap **OK** to return to the *Field-IQ Calibration* screen.

## Calibrating the spraying modules

Calibrate the modules to ensure that your system performs at the level you require.

The Field-IQ Calibrate option only appears on the Configuration screen if you have at least one Field-IQ Rate and Section control module installed.

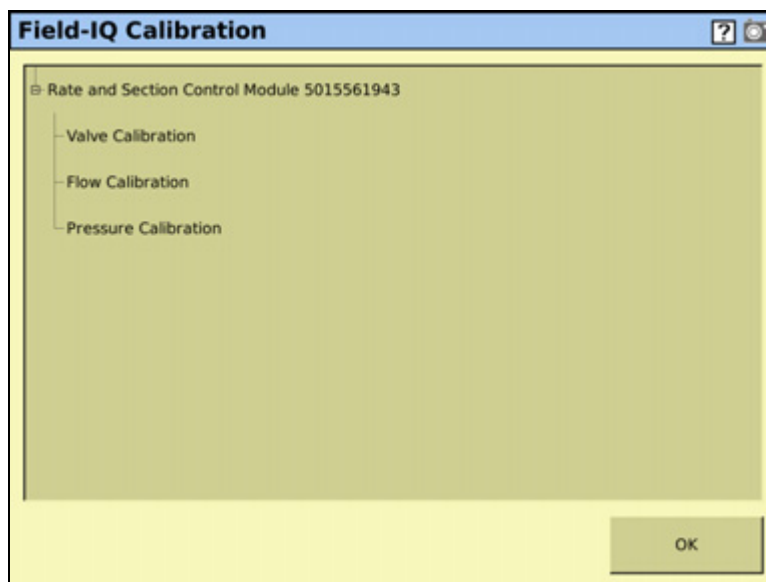

1. From the *Configuration* screen, select the Field-IQ plugin and then tap **Calibrate**.
2. From the *Field-IQ Calibration* screen, select the Rate and Section Control Module to calibrate:



**Note** – If you have an implement lift switch, calibrate it first. See above.

## Drive Calibration

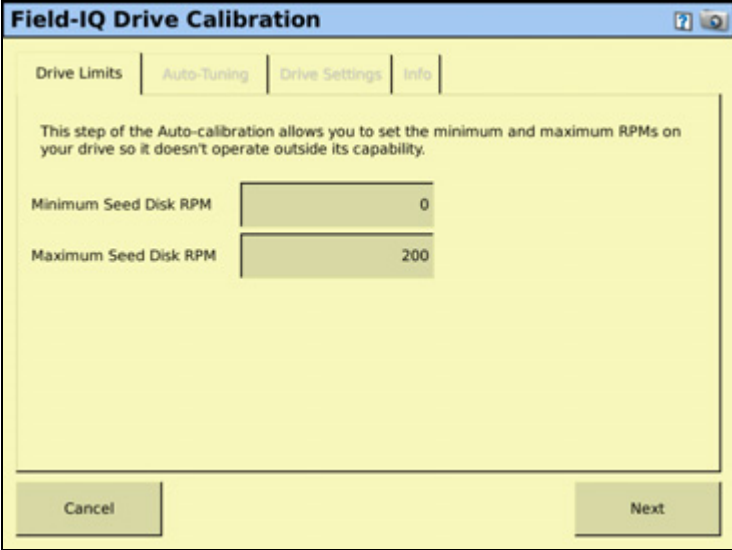
From the *Field-IQ Calibration* screen, select Drive Calibration under the valve you want to calibrate. The *Field-IQ Calibration* screen has four tabs:

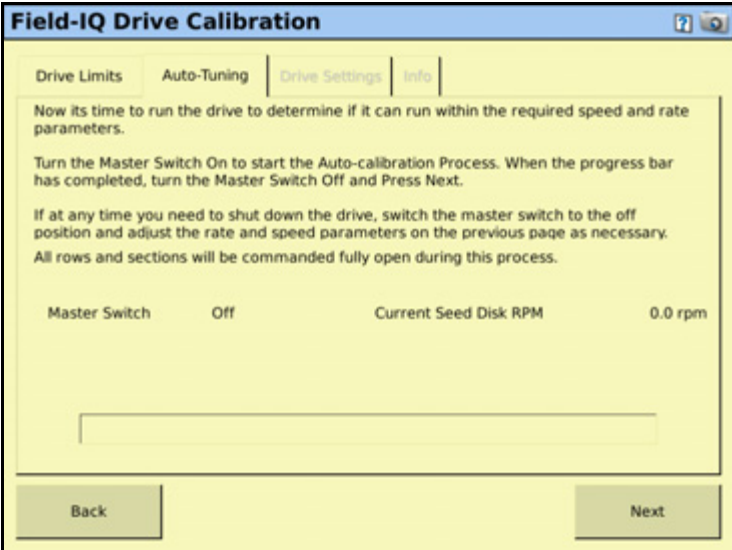
Tab	Description
Drive Limits	<p>Enter the minimum and maximum flow values:</p> 
Auto-Tuning	<p> <b>WARNING</b> – Moving parts during this operation. Ensure that the implement is safe to operate.</p> <p>Follow the on-screen instructions to auto-tune the system:</p>  <p><b>Note</b> – Do not perform the auto-tuning function if you have loaded a preset configuration file. Use the predefined configuration settings appropriate for your vehicle.</p>

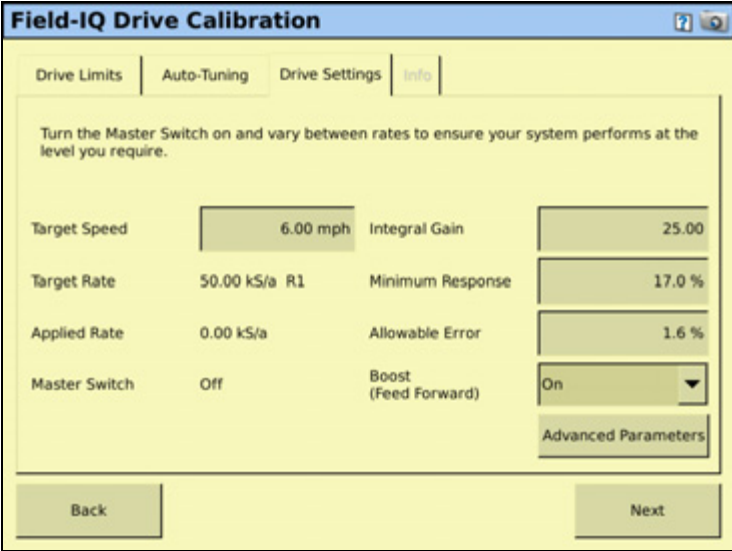
Tab	Description
Drive Settings	<p>Turn the master switch on and vary the rates. Adjust values if needed:</p> 
Info	Shows the results and drive limits of your calibration.

### Flow calibration

From the *Field-IQ Calibration* screen, select *Flow Calibration* under the valve you want to calibrate. The *Rate and Section Control Flow Calibration* screen appears:

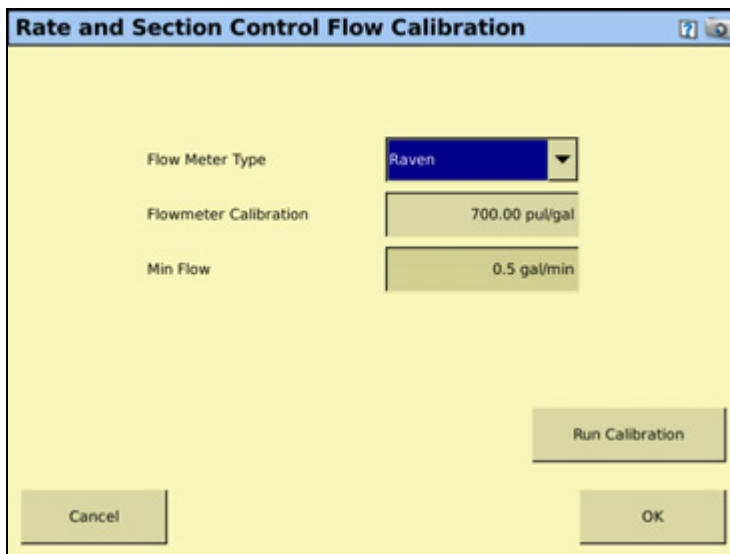

**CAUTION** – Moving parts during this operation. Ensure the implement is safe to operate.

1. Tap **OK**. Enter a value for each of the following:
  - *Flow Meter Type*: select an option from the drop-down list.

- *Flowmeter Calibration*: enter the number from the flow meter tag
  - *MinFlow*: enter the required minimum flow rate for the system. Use this setting to keep the control valve and flow meter above the minimum operating level.
2. Tap **Run Calibration**, and then follow the on-screen instructions.
  3. If used, select the connector that the pressure sensor is connected to, and then enable the sensor.
  4. Tap **Run Calibration**, and then follow the on-screen instructions.
  5. Tap **OK** to return to the *Configuration* screen.

## Operating in the field

1. From the Home screen, tap .
2. From the *Current Configurations* screen, configure the display/vehicle/ implement settings and then tap **OK**.
3. From the *Field Selection* screen, select the required client/farm/field/event settings and then tap **OK**.

## Setting up the Field-IQ system for Spreading

Make sure that you have set your implement to Spreading, and that you have configured the implement, see [Configuring the display, page 73](#). In the *Material Overview* screen, tap **New** to open the Field-IQ Setup Wizard. The Wizard contains the following seven tabs:

For information on this tab...	See...
Material	<a href="#">page 308</a>
Layout	<a href="#">page 309</a>
Section Control	<a href="#">page 310</a>
Sensors	<a href="#">page 317</a>
Operation	<a href="#">page 318</a>

## Material tab

Enter information about the material you want to set up.

Setting	Description
Material Type	Select your Field-IQ application type: <b>Note</b> – <i>If spraying chemicals, use the liquid fertilizer setting.</i> <ul style="list-style-type: none"> <li>• Row Crop Seed</li> <li>• Liquid</li> <li>• Granular Seed</li> <li>• Granular Fertilizer</li> <li>• Anhydrous</li> </ul>
Material Name	Use the virtual keyboard to enter a name for the material.
Application Rate	<p><b>Rates tab</b></p> <p>Adjust the following Rate settings:</p> <ul style="list-style-type: none"> <li>• Target Rate: This setting controls the volume that the implement supplies when the Rate switch is in position 1.</li> <li>• Target Rate 2: This setting controls the volume that the implement supplies when the Rate switch is in position 2.</li> <li>• Rate Increment: When the Rate switch is in the Rate 1 or Rate 2 position, the current application rate increases or decreases by this amount each time you press the Rate adjustment (increment/decrement) switch on your master switch box.</li> <li>• Manual Rate Increment: When the Rate switch is in the Manual position, the current application rate increases or decreases by this amount each time you press the Rate adjustment (increment/decrement) switch on your master switch box.</li> <li>• Minimum Rate: This setting is the minimum rate that will be applied.</li> <li>• Maximum Rate: This setting is the maximum rate that will be applied</li> </ul> <p><b>Units tab</b></p> <p>Adjust the following Unit settings:</p> <ul style="list-style-type: none"> <li>• Seeds Per Pound: Enter the number of seeds per pound of the current material.</li> <li>• Target Rate Units: Choose what units your target rate will apply.</li> <li>• Bushel Weight: Enter the bushel weight of the current material.</li> </ul>



## Layout tab

Enter information about the implement that will be used to apply the material.

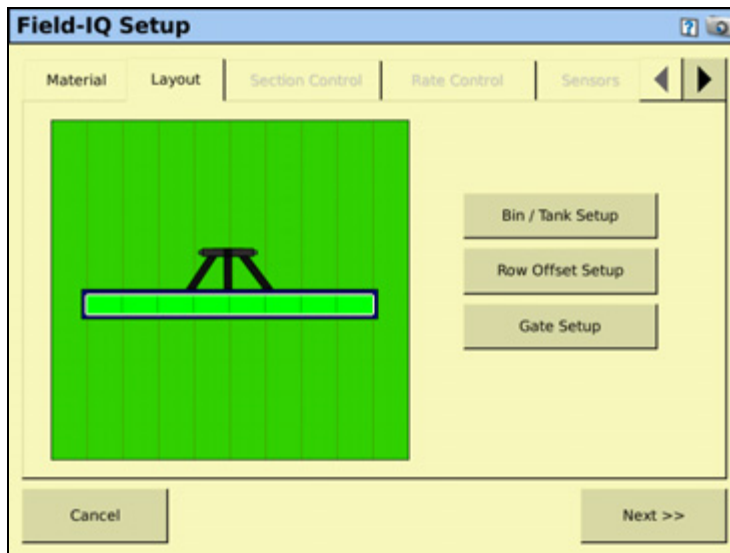

Setting	Description
Bin/Tank Setup	<p>Allows the system to track how much material is left in the bin/tank, and provides a warning when the bin/tank needs to be refilled. Adjust the settings for:</p> <ul style="list-style-type: none"> <li>• Status: <ul style="list-style-type: none"> <li>On: The system will track the bin/tank level and provide warnings.</li> <li>Off: The system will not track the bin/tank level or provide warnings.</li> </ul> </li> <li>• Capacity Units: Select Default Units or Bushels. Default units will vary according to the type of material that is being applied.</li> <li>• Bin Capacity: The amount the tank/bin holds when full.</li> </ul> <p><b>Note</b> – <i>Markings on tank/bin may not be accurate.</i></p> <ul style="list-style-type: none"> <li>• Current Volume: Current volume of the product in the tank.</li> <li>• Partial Refill: The amount of material that will be added to the bin/tank during a partial refill.</li> <li>• Warning Level: A warning will appear on your screen when your bin/tank reaches a set threshold.</li> <li>• Refill Tank/Bin: Refills the tank/bin to capacity.</li> <li>• Partial Refill Tank/Bin: Refills the tank/bin to the amount specified in the <i>Partial Refill</i> field.</li> </ul>

Setting	Description
Row Offset Setup	<p>Row Offset Setup provides additional tuning by detailing where the material will be applied in relation to the vehicle. Increase coverage accuracy by selecting one or two offsets.</p> <p>Row offsets are measured from the Application Offset that is entered in the Measurements tab of the Implement Configuration wizard. See Implement Configuration, Measurements, page 165.</p> <ul style="list-style-type: none"> <li>• Number of row offsets: Use 1 row offset when coverage is applied at a single location. Use two row offsets when planting singulated seed with staggered implements.</li> <li>• Row Offset (1 row offset): Enter the distance between the Application Offset and the row.</li> <li>• Rear Row Offset (2 row offset): Enter the distance between the Application Offset and the rear row.</li> <li>• Front Row Offset (2 row offset): Enter the distance between the Application Offset and the front row.</li> </ul>
Gate Setup	<p>Enter the following measurements:</p> <ul style="list-style-type: none"> <li>• Gate Height</li> <li>• Gate Width</li> <li>• Drag chain length per turn of the drag shaft</li> </ul>

## Section Control tab

Adjust the section control settings.

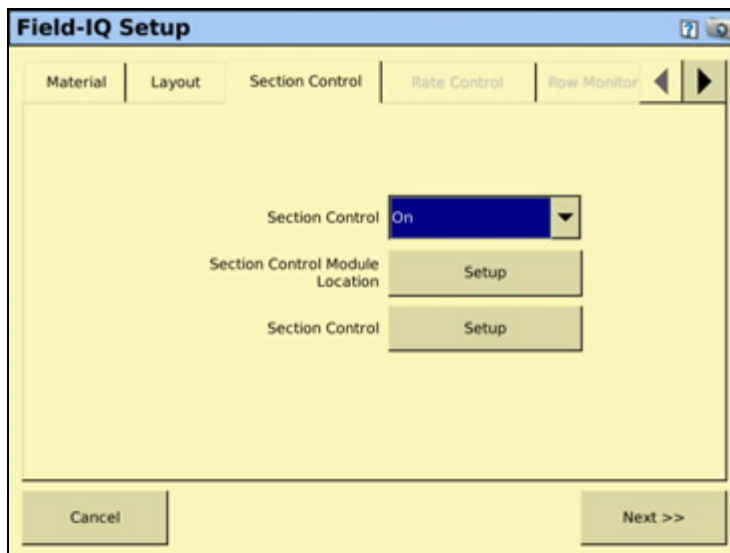

Setting	Description
Section Control	<p>On: Enable section control for the current material.  Off: Disable section control for the current material.  Rate as Section: When a rate controller turns on or off, the section turns on or off.  Link to Material: See <a href="#">Linking materials, page 261</a>.</p>

Setting	Description
Section Control Module Setup	<p>Tap <b>Setup</b> to configure the section control module(s), their location on the implement, and the number of sections they will control.</p> <p>Assign the Field-IQ module to the correct location to ensure it controls the correct section.</p> <ul style="list-style-type: none"> <li>• Number of Modules: Enter the number of Field-IQ section control modules you will use.</li> <li>• Module: Select the module number that corresponds to each section.</li> <li>• Number of Sections: Assign the number of sections that each module will control.</li> <li>• Section Grouping: Assign the rows that are in each section.</li> <li>• Advanced Wire Assignment: Every section is controlled by a specific wire on each Field-IQ module. Use this setting to specify which module each section is wired to.</li> </ul>
Section Control	<p>Tap <b>Setup</b> to adjust settings for each section control module.</p> <ul style="list-style-type: none"> <li>• Section Control Type: Select the type of section control for each module.</li> <li>• Off When Stopped: When set to Yes the control valve will close when ground speed reaches 0 with the master switch position in On. When set to No the control valve will hold its last position when the master switch is shut off and ground speed reaches 0—if the vehicle is a clutch-operated planter, set this option to No so that you can continue planting when the vehicle is stopped. Otherwise, select Yes.</li> <li>• On Latency: By default, this is set to 0.0 seconds. Use this setting unless you are experiencing a long response time from your clutch or valve (this can happen on larger systems). In this case, increase the On Latency value to compensate the delay, and the system will turn on in advance.</li> <li>• Off Latency: By default, this is set to 0.0 seconds. Use this setting unless you are experiencing a long response time from your clutch or valve (this can happen on larger systems). In this case, increase the Off Latency value to compensate for the delay, and the system will turn off after the set number of seconds.</li> <li>• Start Overlap: Enter the distance of intentional swath overlap when entering a previously applied area. The higher the number, the greater the overlapped area.</li> <li>• End Overlap: Enter the distance of intentional swath overlap when exiting a previously applied area. The higher the number, the greater the overlapped area.</li> <li>• Coverage Switching Overlap: Enter the percentage of the section width for intentional swath overlap. The higher the number, the greater the overlapped area before the section is turned off.</li> <li>• Boundary Switching Overlap: Enter the percentage of the section width for intentional overlap of a boundary. The higher the number, the greater the overlapped area into the boundary area.</li> </ul>

## Rate Control tab

Adjust the rate control settings.

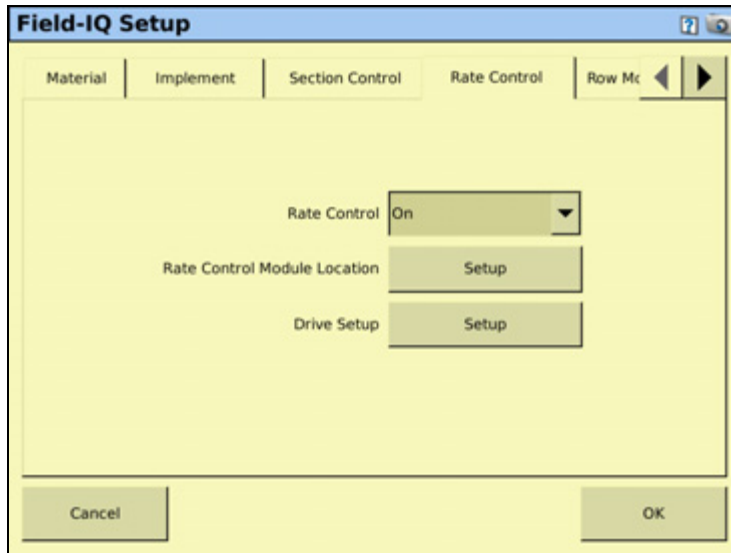

Setting	Description
Rate Control	On: The system sets the target rate. Off: Section switching only
Rate Control Module Location	Tap <b>Setup</b> to configure the rate control module(s), their location on the implement, and the width they will control.
Drive Setup	When you tap <b>Drive Setup</b> , a screen appears with the following tabs: <ul style="list-style-type: none"> <li>• Valve Setup</li> <li>• Feedback Setup</li> <li>• Advanced</li> </ul> The tabs are explained in more detail on the following pages.

## Drive Setup

### Valve Setup tab

The screenshot shows a dialog box titled "Rate and Section Controller Valve Calibration" with a "Valve" tab selected. The settings are as follows:

Setting	Value
Valve Type	PWM
Plumbing	inline
Valve Behavior On Sections Closed	Close
Auxiliary Valve	Dump
Pump Disarming Switch	Disabled

Setting	Description
Valve Type	Servo: 2-wire standard servo valve Fast Servo: 4-wire servo valve PWM: 2-wire PWM valve (commonly used to control hydraulic flow).
Plumbing	Inline: Valve is in the solution line going to the boom. The valve opens to increase the application rate. Bypass: Valve is in the return-to-tank line. The valve closes to increase the application rate.
Valve Behavior On Sections Closed	Close: When all sections are off, the control valve returns to the closed position. Lock in Last Position: When all sections are off, the control valve remains in the last position. This setting allows the system to return to the target rate faster.
Auxiliary Valve	Master: Valve closes when the system is turned off. Dump: Valve opens to dump flow-to-return line when the system is turned off.
Pump Disarming Switch	Enable: Select this option if you have a pump disarming switch installed. Disable: Select this option if you do not have a pump disarming switch installed.

### Feedback Setup tab

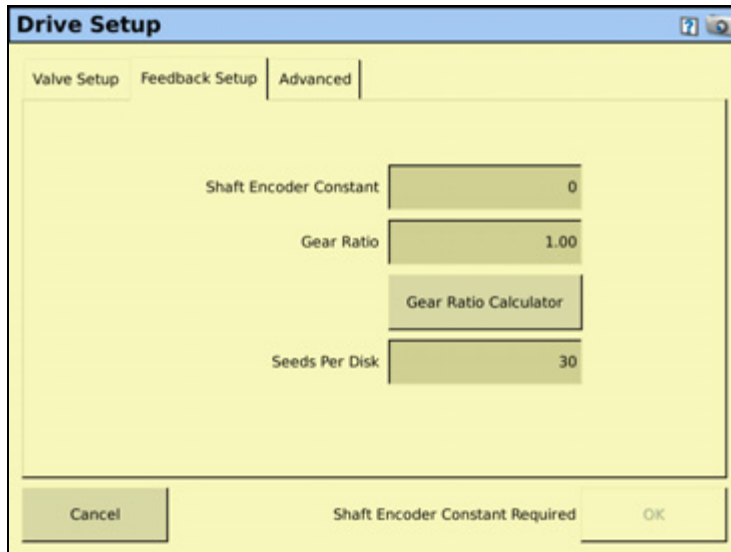

Setting	Description
Shaft Encoder Constant	Pulses per revolution.
Gear Ratio	Specifies the actual ratio from the application rate sensor to the seed meter shaft RPM. This is the number of revolutions the application rate sensor turns for each revolution of the seed meter.
Gear Ratio Calculator	Use the calculator to determine your gear ratio.
Seeds Per Disk	The number of seed openings per disk plate.

### Valve calibration

1. Tap *Valve Calibration*. The following screen appears:

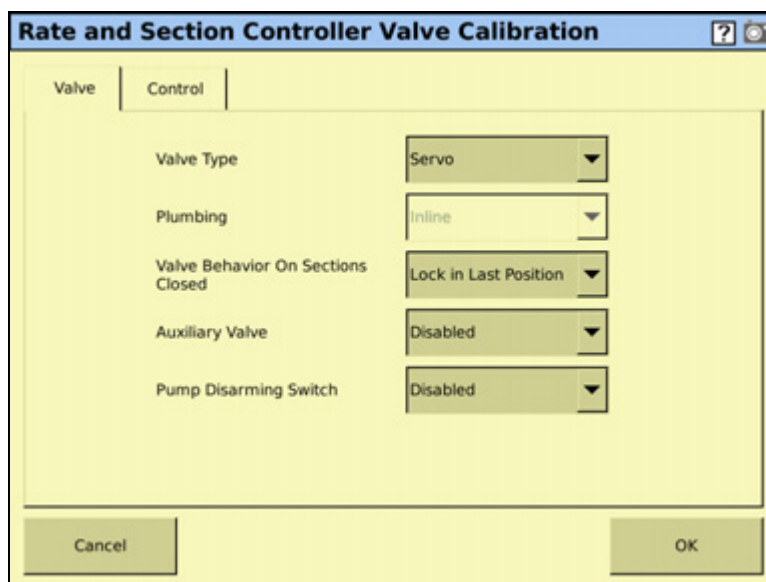

2. Select the *Valve* tab and then select the appropriate value for each field:

For this field ...	Select one of the following options ...
Valve Type	<b>Pump Servo:</b> The Pump Servo setting controls an electric motor which actuates a hydraulic valve. As the valve actuates, it adjusts the hydraulic flow to the pump. This valve adjusts the application rate indirectly.
	<b>PWM:</b> The PWM pump setting controls an electric solenoid valve which adjusts the hydraulic flow to the pump. This valve adjusts the application rate indirectly.
	<b>Fast Servo:</b> A 4 wire electric motor turns a ball or butterfly valve to increase or decrease flow, for example a DICKEY-john servo, Mid-Tech servo, or Raven Fast Valve.
	<b>Servo:</b> A 2 wire electric motor turns a ball or butterfly valve to increase or decrease flow, for example a Raven standard servo.
	<b>Hardi % bypass scenario:</b> Most commonly used on Hardi sprayers equipped with 3 way section valves that return flow to tank when the boom section is off.
Plumbing	<b>Inline:</b> Valve is in the solution line going to the boom. The valve opens to increase application rate.
	<b>Bypass:</b> Valve is in the Return to Tank line. The valve closes to increase the application rate.
Valve Behavior on Sections Closed	<b>Close:</b> When all sections are off, the control valve returns to the closed position.
	<b>Lock in Last Position:</b> When all sections are off, the control valve remains in the last position. This setting allows the system to return to the target rate faster.
Auxiliary Valve	If you have an Auxiliary Valve installed, select one of the following:
	<b>Master:</b> Valve closes when the system is turned off.
	<b>Dump:</b> Valve opens to dump flow to return line when the system is turned off.
Pump Disarming Switch	<b>Enable:</b> Select this option if you have a Pump Disarming Switch installed.

### Feedback Setup tab

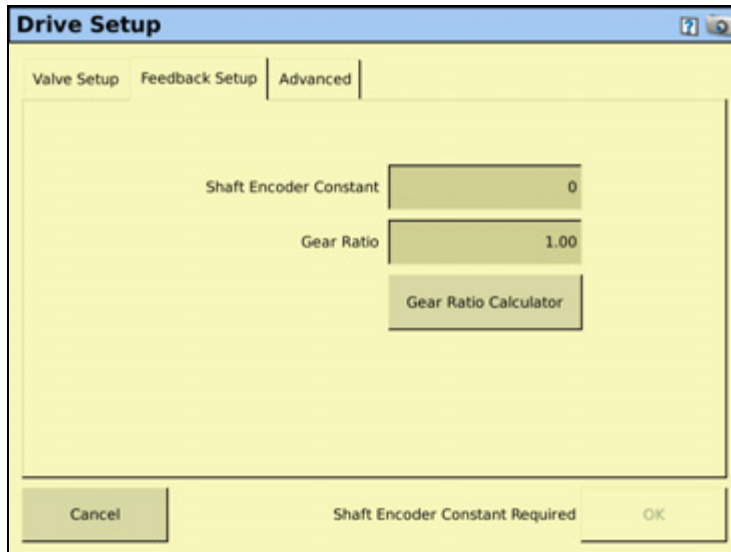

Setting	Description
Shaft Encoder Constant	Pulses per revolution.
Gear Ratio	Specifies the actual ratio from the application rate sensor to the seed meter shaft RPM. This is the number of revolutions the application rate sensor turns for each revolution of the seed meter.
Gear Ratio Calculator	Use the calculator to determine your gear ratio.



## Sensors tab

Add or edit sensor settings.

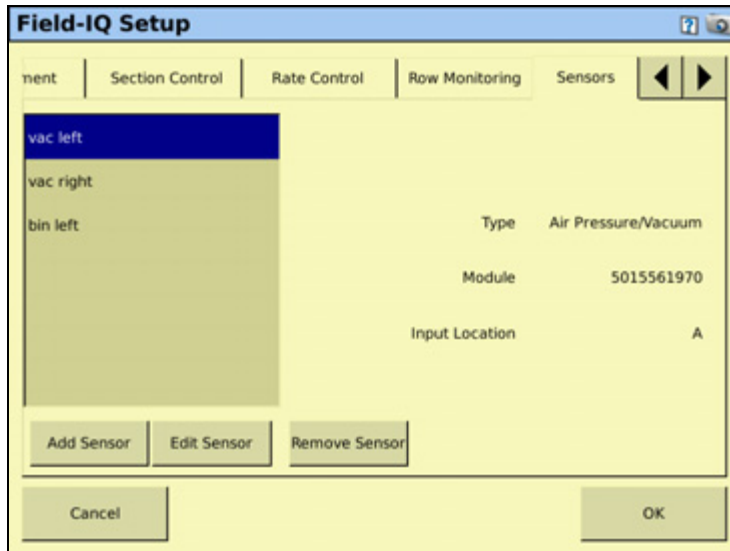

Setting	Description
Add Sensor	Add a new sensor.
Edit Sensor	Edit or view the settings for an existing sensor.
Remove Sensor	Delete an existing sensor.

When adding or editing a sensor, enter the following information:

Setting	Description
Sensor Type	Select from: <ul style="list-style-type: none"> <li>• Air pressure/vacuum</li> <li>• Liquid pressure</li> <li>• NH3 pressure</li> <li>• Bin level</li> <li>• RPM</li> <li>• Gate Height</li> </ul>
Name	Use the virtual keyboard to enter a name for the sensor.
Sensor Setup	Field-IQ module: Select the Field-IQ module that is controlling this sensor. Input location: Specify which wire is controlling the sensor.

## Operation tab

**Field-IQ Setup**

on Control | Rate Control | Row Monitoring | Sensors | Operation

Jump Start Speed: 5.00 mph

Shutoff Speed: 0.36 mph

Minimum Override Speed: 0.00 mph

When Outside Field Boundary: Switch Off

Material Controlled By: Switch Boxes

Rate Snapping: Off

\*Switch Boxes include both Master & Section boxes. If you do not select Switch Boxes you will be unable to calibrate your material.

Cancel OK

Setting	
Jump Start Speed	This setting controls the speed to be used when the Field-IQ master switchbox Master switch is put in the jump start position. This manual override option can be used to operate the system when the vehicle is stationary. Jump start is also used when GPS has become unavailable.
Shutoff Speed	This setting controls when to shut the system down if the implement drops below the specified speed.
Minimum Override Speed	This setting maintains the application rate when the implement's actual speed drops below the value entered. It is used to ensure consistent material flow during slow speeds.
When Outside Field Boundary	Switch off: The system will not apply outside the boundary area. Operate: The system will apply outside the boundary area.
Material Controlled By	Enabled: The material is tied to the Master Switch Box and cannot be controlled individually. Disabled: The Material is not tied to the Master Switch box and is controlled by virtual buttons on the Run screen.
Rate Snapping	Enabled: Shows the applied rate the same as the target rate, if the applied rate is within 10% of the target rate. Disabled: Shows the actual applied value.

## Material Setup Complete screen

When you have completed setting up a new material, the *Material Setup Complete* screen appears. You can select:

- **Add another material.** You are returned to the start of the *Field-IQ Setup Wizard*.
- **Finish Setup.** You are returned to the *Material Overview* screen.

## Calibrating the implement lift switch

1. From the *Field-IQ Calibration* screen, select the Implement Lift option.
2. Raise the implement and then tap **Next**.
3. Lower the implement and then tap **Next**.
4. Tap **OK** to return to the *Field-IQ Calibration* screen.

## Calibrating the Rawson modules for spreading

Calibrate the modules to ensure that your system performs at the level you require.

The *Field-IQ Calibrate* option only appears on the *Configuration* screen if you have at least one *Field-IQ Rawson* control module or rate control module set up to control the rate.

1. From the *Configuration* screen, select the *Field-IQ* plugin and then tap **Calibrate**.
2. From the *Field-IQ Calibration* screen, select the module you want to calibrate.

*Note* – If you have an implement lift switch, calibrate it first. See above.

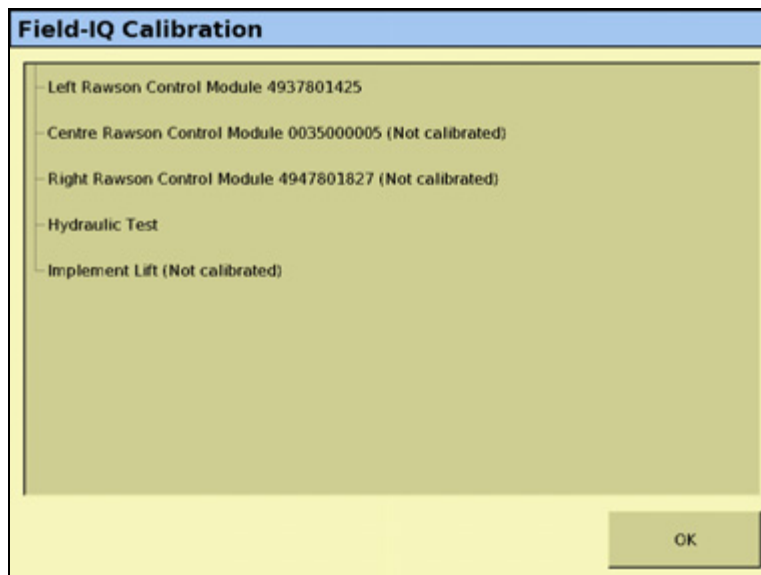

3. Select the first module to calibrate. The *Planter Calibration* screen appears:

*Note – If a Rawson module was configured, the correct calibration is selected automatically.*

Setting	Description
Gear Ratio	Specifies the actual ratio from the applicaiton rate sensor to the seed meter shaft RPM. This is the number of revolutions the application rate sensor turns for each revolution of the seed meter.
Gear Ratio Calculator	Use the calculator to determine your gear ratio.
Calibration Constant	A calculated value that the system determines during calibration. This field allows you to adjust for inconsistencies in the seed meters. To start out, leave the value at 1.000. After the calibration test, the system may adjust this number.

4. Place a clean empty container under the rows that contain seeds to capture the seeds dispensed during the calibration.



**CAUTION** – Moving parts during this operation. Ensure the implement is safe to operate.

5. Tap **Test**:
  - a. The system asks if you would like to prime the system. Tap **Yes**. To ensure that the seed disk is full, the system turns the seed disks one revolution.
  - b. Turn on the master switch to prime the system and then when prompted on-screen, turn off the master switch.
  - c. In the *Number of Seed Meter Revolutions*, enter a value and then tap **Start**. The higher the number of revolutions the more accurate the calibration. Five to 10 revolutions is recommended.
  - d. Follow the on-screen prompts of operating the master switch. After the system turns the specified number of revolutions, enter the number of seeds dispensed per row and then tap **Continue**.
  - e. The next screen shows the minimum and maximum speeds for the target rate specified. Tap **OK** and then either press **Test** to repeat the calibration or tap **OK** to continue.

- Select the *Limits* tab to show an overview of the limits that are set:

The screenshot shows the 'Planter Calibration' window with the 'Limits' tab selected. It displays two tables of settings. The first table, 'Speed Limits', has columns for 'Rate', 'Min Speed', and 'Max Speed'. The second table, 'Jump Start', has columns for 'Speed', 'Min Rate', and 'Max Rate'. At the bottom are 'Cancel' and 'OK' buttons.

Speed Limits	Rate	Min Speed	Max Speed
Target Rate 1	30.00 kS/a	2.99 mph	8.96 mph
Target Rate 2	24.00 kS/a	3.73 mph	11.20 mph

Jump Start	Speed	Min Rate	Max Rate
	6.00 mph	14.93 kS/a	44.78 kS/a

- Tap **OK**.
- Repeat Step 1 through Step 7 for other Rawson Control Modules that need calibration.

### Hydraulic test

The purpose of this test is to exercise the hydraulics to establish whether there is sufficient oil flow to run the system.

- From the Field-IQ *Calibration* screen tap **Hydraulic Test**.



**CAUTION** – Moving parts during this operation. Ensure the implement is safe to operate.

- Tap **Next**.
- Enter the initial motor RPM. The default setting is 300. Trimble also recommends that you test the motor RPM at 100 to ensure that the drive runs smoothly at slow speeds.
- Tap **Start**.

5. The next screen provides the status of each motor:

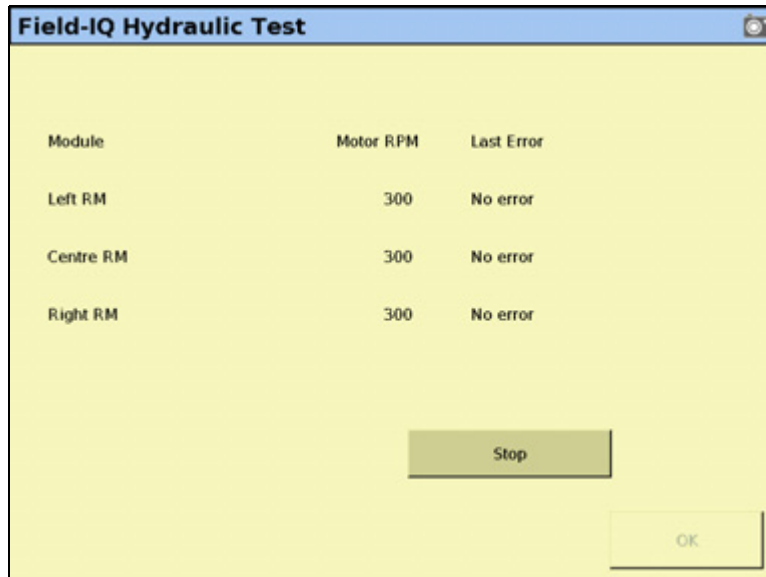

The screenshot shows a window titled "Field-IQ Hydraulic Test" with a yellow background. It contains a table with three columns: "Module", "Motor RPM", and "Last Error". The table lists three motor modules: "Left RM", "Centre RM", and "Right RM", each with a "Motor RPM" of 300 and a "Last Error" of "No error". Below the table are two buttons: "Stop" and "OK".

Module	Motor RPM	Last Error
Left RM	300	No error
Centre RM	300	No error
Right RM	300	No error

**No Error:** The test was successful.

**Motor Stalled:** The motors did not have sufficient oil flow; ensure the correct orifice size is installed for each motor. For more information, refer to the *Rawson System Installation Instructions*.

**Disconnected:** The Rawson Control Module cannot communicate with the motor.

6. Tap **Stop** to return to the Field-IQ *Calibration* screen.

## Calibrating the PWM valves

### Drive Calibration

From the *Field-IQ Calibration* screen, select Drive Calibration under the valve you want to calibrate. The *Field-IQ Calibration* screen has four tabs:

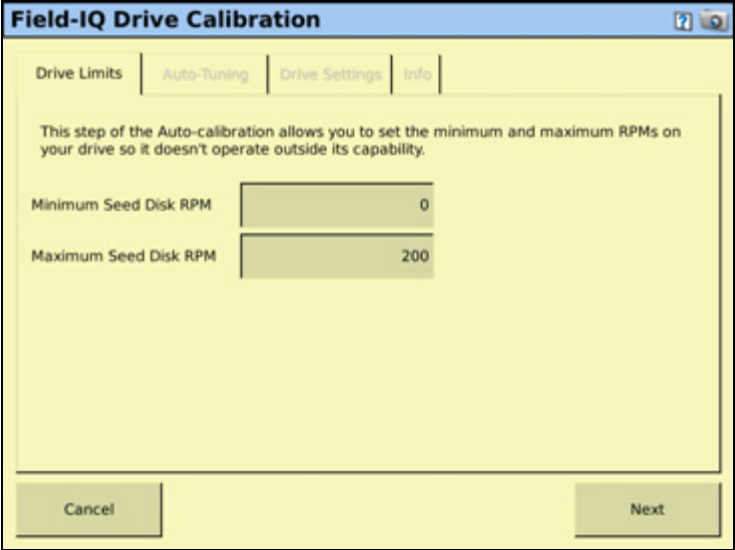
Tab	Description
Drive Limits	<p>Enter the minimum and maximum flow values:</p> 

Tab	Description																
Auto-Tuning	<div data-bbox="516 310 570 363" style="display: inline-block; vertical-align: top; margin-right: 10px;"> </div> <div data-bbox="626 317 1360 380" style="border: 1px solid black; padding: 5px;"> <p><b>WARNING</b> – Moving parts during this operation. Ensure that the implement is safe to operate.</p> </div> <p>Follow the on-screen instructions to auto-tune the system:</p> <div data-bbox="516 457 1243 1003" style="border: 1px solid black; padding: 10px; margin: 10px 0;"> <p><b>Field-IQ Drive Calibration</b></p> <p>Drive Limits   <b>Auto-Tuning</b>   Drive Settings   Info</p> <p>Now its time to run the drive to determine if it can run within the required speed and rate parameters.</p> <p>Turn the Master Switch On to start the Auto-calibration Process. When the progress bar has completed, turn the Master Switch Off and Press Next.</p> <p>If at any time you need to shut down the drive, switch the master switch to the off position and adjust the rate and speed parameters on the previous page as necessary. All rows and sections will be commanded fully open during this process.</p> <p>Master Switch      Off                      Current Seed Disk RPM      0.0 rpm</p> <p style="text-align: center;"> <input style="width: 100%;" type="text"/> </p> <p style="text-align: center;"> <input type="button" value="Back"/>                      <input type="button" value="Next"/> </p> </div> <p><b>Note</b> – Do not perform the auto-tuning function if you have loaded a preset configuration file. Use the predefined configuration settings appropriate for your vehicle.</p>																
Drive Settings	<p>Turn the master switch on and vary the rates. Adjust values if needed:</p> <div data-bbox="516 1167 1243 1713" style="border: 1px solid black; padding: 10px; margin: 10px 0;"> <p><b>Field-IQ Drive Calibration</b></p> <p>Drive Limits   Auto-Tuning   <b>Drive Settings</b>   Info</p> <p>Turn the Master Switch on and vary between rates to ensure your system performs at the level you require.</p> <table border="0" style="width: 100%;"> <tr> <td>Target Speed</td> <td><input type="text" value="6.00 mph"/></td> <td>Integral Gain</td> <td><input type="text" value="25.00"/></td> </tr> <tr> <td>Target Rate</td> <td>50.00 kS/a R1</td> <td>Minimum Response</td> <td><input type="text" value="17.0 %"/></td> </tr> <tr> <td>Applied Rate</td> <td>0.00 kS/a</td> <td>Allowable Error</td> <td><input type="text" value="1.6 %"/></td> </tr> <tr> <td>Master Switch</td> <td>Off</td> <td>Boost (Feed Forward)</td> <td><input type="button" value="On"/> ▼</td> </tr> </table> <p style="text-align: right;"><input type="button" value="Advanced Parameters"/></p> <p style="text-align: center;"> <input type="button" value="Back"/>                      <input type="button" value="Next"/> </p> </div>	Target Speed	<input type="text" value="6.00 mph"/>	Integral Gain	<input type="text" value="25.00"/>	Target Rate	50.00 kS/a R1	Minimum Response	<input type="text" value="17.0 %"/>	Applied Rate	0.00 kS/a	Allowable Error	<input type="text" value="1.6 %"/>	Master Switch	Off	Boost (Feed Forward)	<input type="button" value="On"/> ▼
Target Speed	<input type="text" value="6.00 mph"/>	Integral Gain	<input type="text" value="25.00"/>														
Target Rate	50.00 kS/a R1	Minimum Response	<input type="text" value="17.0 %"/>														
Applied Rate	0.00 kS/a	Allowable Error	<input type="text" value="1.6 %"/>														
Master Switch	Off	Boost (Feed Forward)	<input type="button" value="On"/> ▼														
Info	Shows the results and drive limits of your calibration.																



## Flow calibration

The Field-IQ *Calibration* option only appears on the *Configuration* screen if you have at least one Field-IQ Rate and Section control module installed.

1. From the *Configuration* screen, select the Field-IQ plugin and then tap **Calibrate**.
2. From the *Field-IQ Calibration* screen, select the Rate and Section Control Module to be calibrated. (The message **Not calibrated** appears at the end of the modules that need calibration.) The following screen appears:

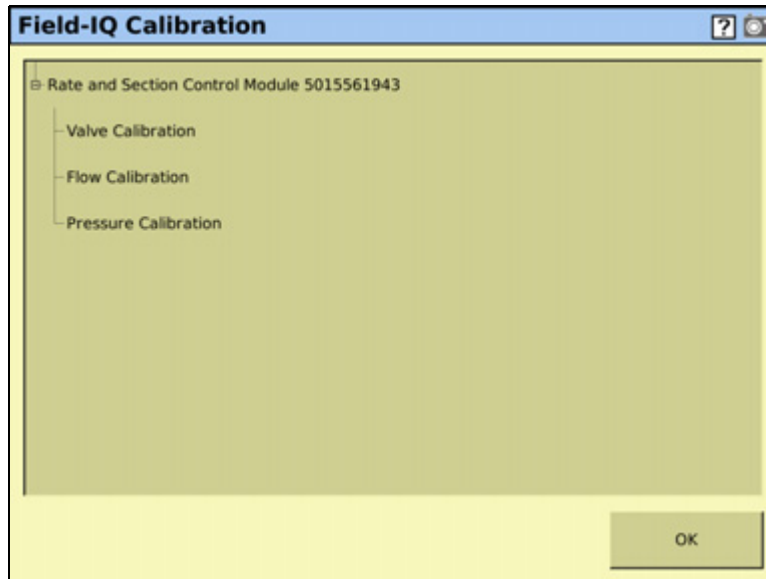

3. Select the *Control* tab:

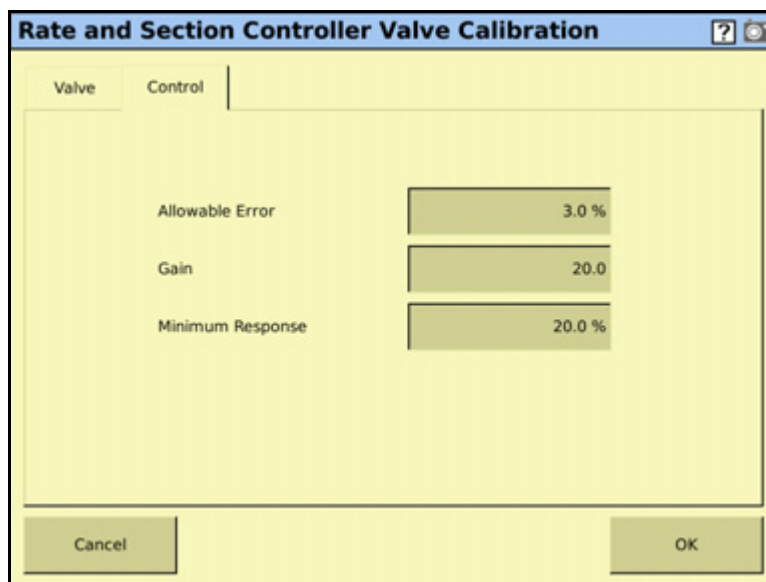

4. Enter the following values:
  - *Allowable Error*

- *Gain*
- *Minimum Response.*

**Note** – For information about the appropriate values for your sprayer, see the Support Note - Field-IQ Crop Input Control System: For Sprayers and Spreaders.

5. Tap **OK** to return to the main calibration screen, and then tap *Flow Calibration*. The following screen appears:

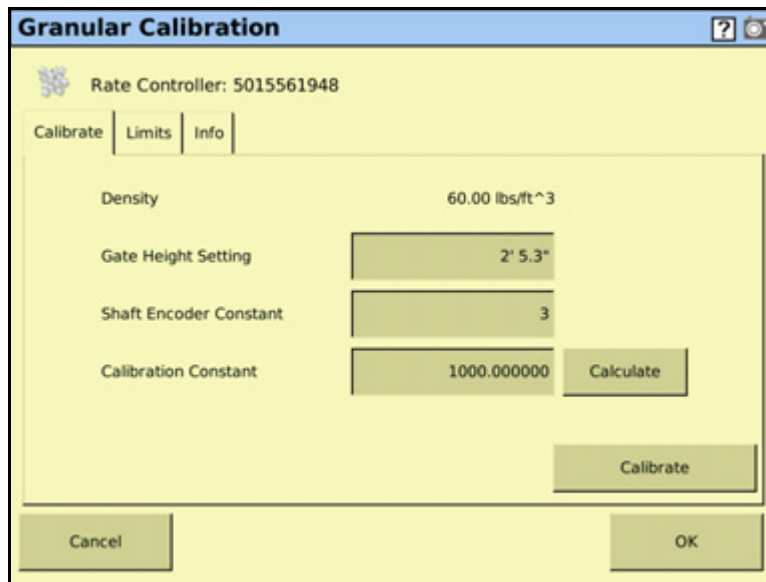

6. Enter the following values:

- *Gate Height Setting*

**Note** – If you entered a gate height measurement during setup, you must also enter a measurement here.

- *Shaft Encoder Constant*

7. To calculate the calibration constant, tap **Calculate**. The following dialog appears.

The screenshot shows a dialog box titled "Calibration Constant Calculator". It has a yellow background and a blue header. The dialog contains three input fields and one output field. The first two fields are for "Gate Width" (1' 0.0") and "Drag Chain Distance Per Rev" (2' 2.0"). The third field is for "Calibration Constant" (201.290725). At the bottom, there are "Cancel" and "OK" buttons.

Field	Value
Gate Width	1' 0.0"
Drag Chain Distance Per Rev	2' 2.0"
Calibration Constant	201.290725

8. Enter the *Gate Width* and *Drag Chain Distance Per Rev*. The system calculates the Calibration Constant.
9. Tap **OK** to return to the *Granular Calibration* Screen.
10. Place a clean empty container under the spreader to capture the material dispensed during the calibration, and then tap **Calibrate**.



**CAUTION** – Moving parts during this operation. Ensure the implement is safe to operate.

11. The *Granular Calibration* screen appears:

The screenshot shows the "Granular Calibration" screen. It has a yellow background and a blue header. The screen displays the "Rate Controller" ID as 5015561943. There are three tabs: "Calibrate", "Limits", and "Info". The "Calibrate" tab is selected. Below the tabs, there is a text prompt: "Enter the desired amount of material to be dispensed, then press Start." There are three input fields: "Amount of Material to be Dispensed" (100.00 lbs), "Target Rate" (200.00 lbs/a), and "Target Speed" (6.00 mph). A "Start" button is located at the bottom right. At the very bottom, there are "Cancel" and "OK" buttons.

Field	Value
Amount of Material to be Dispensed	100.00 lbs
Target Rate	200.00 lbs/a
Target Speed	6.00 mph

12. Enter the following values:
  - *Amount of Material to be Dispensed*: This is the amount dispensed during the calibration.
  - *Target Rate*
  - *Target Speed*
13. To begin the calibration, tap **Start**, and then follow the on-screen instructions.
14. Select the *Info* tab to view the system's operational limits (based on the RPM limits, target rates, and application width):

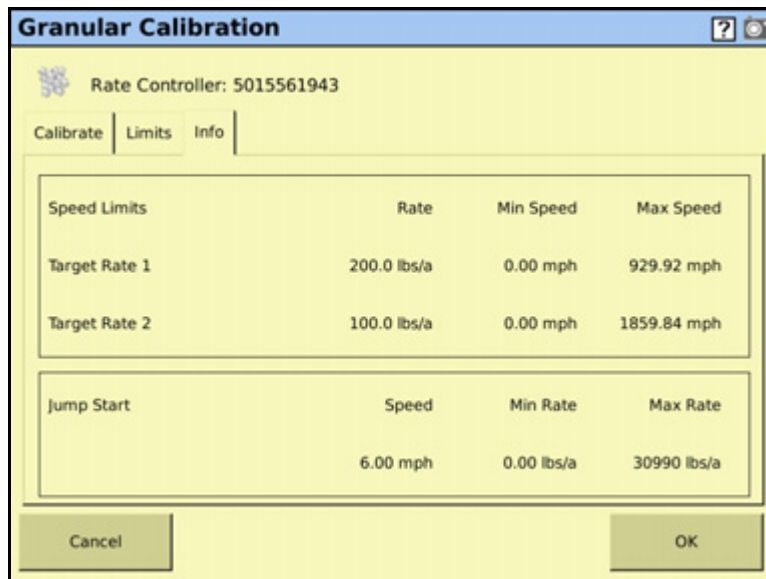

15. Tap **OK**.

## Operating in the field

1. From the Home screen, tap .
2. From the *Current Configurations* screen, configure the display/vehicle/ implement settings and then tap **OK**.
3. From the *Field Selection* screen, select the required client/farm/field/event settings and then tap **OK**.

## Setting up the Field-IQ system for Anhydrous



**WARNING** –  $\text{NH}_3$  is an irritant and corrosive to the skin, eyes, respiratory tract and mucous membranes, and is dangerous if not handled properly. It may cause severe burns to the eyes, lungs, and skin. Skin, and respiratory-related diseases could be aggravated by exposure. It is recommended that protective gloves, boots, slicker and/or pants and jacket, and chemical-splash goggles that are impervious to anhydrous ammonia are worn at all times.

Make sure that you have set your implement to Tillage or Spraying, and that you have configured the implement, see [Configuring the display, page 73](#). In the *Material Overview* screen, tap **New** to open the Field-IQ Setup Wizard. The Wizard contains the following seven tabs:

For information on this tab...	See...
Material	<a href="#">page 329</a>
Layout	<a href="#">page 331</a>
Section Control	<a href="#">page 332</a>
Rate Control	<a href="#">page 334</a>
Sensors	<a href="#">page 337</a>
Operation	<a href="#">page 338</a>

### Material tab

Enter information about the material you want to set up.

The screenshot shows the 'Field-IQ Setup' window with the 'Material' tab selected. The interface includes a tabbed menu at the top with 'Material', 'Layout', 'Section Control', 'Rate Control', and 'Sensors'. Below the menu, there are four input fields: 'Material Type' with a dropdown menu showing 'Anhydrous', 'Material Name' with a text box containing 'NH3', 'Anhydrous Units' with a dropdown menu showing 'Lbs Actual N (kgs)', and 'Application Rate' with a 'Setup' button. At the bottom of the window, there are 'Cancel' and 'Next >>' buttons.

Setting	Description
Material Type	Select your Field-IQ application type, <i>Anhydrous</i> .
Material Name	Use the virtual keyboard to enter a name for the material.

Setting	Description
Anydrous Units	Select the unit of measure: <ul style="list-style-type: none"> <li>• Lbs actual N: Pounds (kg) of nitrogen per acre (hectare)</li> <li>• Lbs NH3: Pounds (kg) of anhydrous per acre (hectare)</li> </ul>
Application Rate	<p><b>Rates tab</b></p> Adjust the following Rate settings: <ul style="list-style-type: none"> <li>• Target Rate: This setting controls the volume that the implement supplies when the Rate switch is in position 1.</li> <li>• Target Rate 2: This setting controls the volume that the implement supplies when the Rate switch is in position 2.</li> <li>• Rate Increment: When the Rate switch is in the Rate 1 or Rate 2 position, the current application rate increases or decreases by this amount each time you press the Rate adjustment (increment/decrement) switch on your master switch box.</li> <li>• Manual Rate Increment: When the Rate switch is in the Manual position, the current application rate increases or decreases by this amount each time you press the Rate adjustment (increment/decrement) switch on your master switch box.</li> <li>• Minimum Rate: This setting is the minimum rate that will be applied.</li> <li>• Maximum Rate: This setting is the maximum rate that will be applied</li> </ul> <p><b>Units tab</b></p> Adjust the following Unit settings: <ul style="list-style-type: none"> <li>• Seeds Per Pound: Enter the number of seeds per pound of the current material.</li> <li>• Target Rate Units: Choose what units your target rate will apply.</li> <li>• Bushel Weight: Enter the bushel weight of the current material.</li> </ul>

## Layout tab

Enter information about the implement that will be used to apply the material.

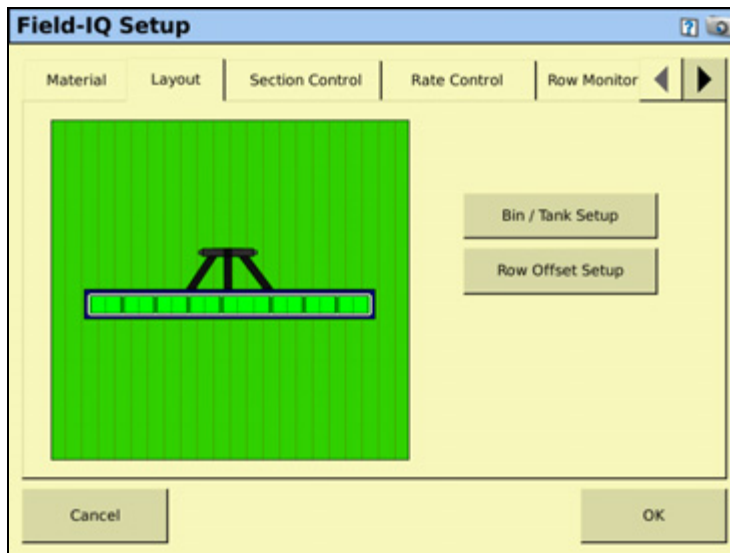

Setting	Description
Bin/Tank Setup	<p>Allows the system to track how much material is left in the bin/tank, and provides a warning when the bin/tank needs to be refilled. Adjust the settings for:</p> <ul style="list-style-type: none"> <li>• Status: <ul style="list-style-type: none"> <li>On: The system will track the bin/tank level and provide warnings.</li> <li>Off: The system will not track the bin/tank level or provide warnings.</li> </ul> </li> <li>• Capacity Units: Select Default Units or Bushels. Default units will vary according to the type of material that is being applied.</li> <li>• Bin Capacity: The amount the tank/bin holds when full.</li> </ul> <p><b>Note</b> – <i>Markings on tank/bin may not be accurate.</i></p> <ul style="list-style-type: none"> <li>• Current Volume: Current volume of the product in the tank.</li> <li>• Partial Refill: The amount of material that will be added to the bin/tank during a partial refill.</li> <li>• Warning Level: A warning will appear on your screen when your bin/tank reaches a set threshold.</li> <li>• Refill Tank/Bin: Refills the tank/bin to capacity.</li> <li>• Partial Refill Tank/Bin: Refills the tank/bin to the amount specified in the <i>Partial Refill</i> field.</li> </ul>

Setting	Description
Row Offset Setup	<p>Row Offset Setup provides additional tuning by detailing where the material will be applied in relation to the vehicle. Increase coverage accuracy by selecting one or two offsets.</p> <p>Row offsets are measured from the Application Offset that is entered in the Measurements tab of the Implement Configuration wizard. See Implement Configuration, Measurements, page 165.</p> <ul style="list-style-type: none"> <li>• Number of row offsets: Use 1 row offset when coverage is applied at a single location. Use two row offsets when planting singulated seed with staggered implements.</li> <li>• Row Offset (1 row offset): Enter the distance between the Application Offset and the row.</li> <li>• Rear Row Offset (2 row offset): Enter the distance between the Application Offset and the rear row.</li> <li>• Front Row Offset (2 row offset): Enter the distance between the Application Offset and the front row.</li> </ul>

### Section Control tab

Adjust the section control settings.

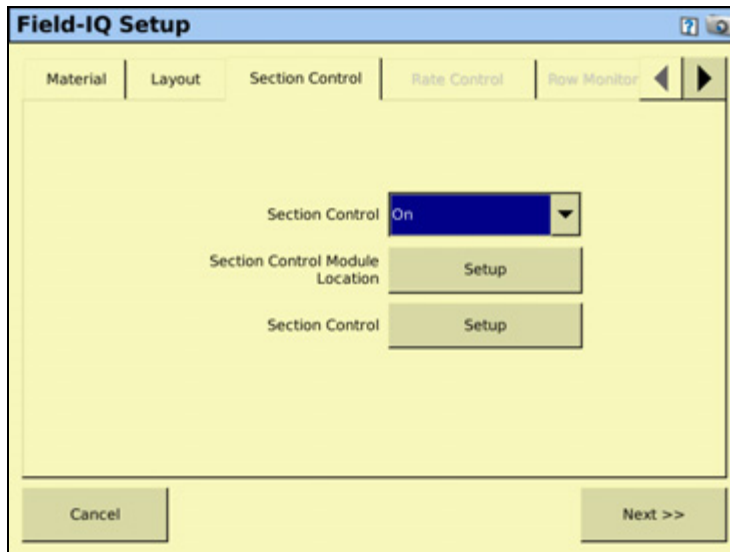

Setting	Description
Section Control	<p>On: Enable section control for the current material.</p> <p>Off: Disable section control for the current material.</p> <p>Rate as Section: When a rate controller turns on or off, the section turns on or off.</p> <p>Link to Material: See <a href="#">Linking materials, page 261</a>.</p>



Setting	Description
Section Control Module Setup	<p>Tap <b>Setup</b> to configure the section control module(s), their location on the implement, and the number of sections they will control.</p> <p>Assign the Field-IQ module to the correct location to ensure it controls the correct section.</p> <ul style="list-style-type: none"> <li>• Number of Modules: Enter the number of Field-IQ section control modules you will use.</li> <li>• Module: Select the module number that corresponds to each section.</li> <li>• Number of Sections: Assign the number of sections that each module will control.</li> <li>• Section Grouping: Assign the rows that are in each section.</li> <li>• Advanced Wire Assignment: Every section is controlled by a specific wire on each Field-IQ module. Use this setting to specify which module each section is wired to.</li> </ul>
Section Control	<p>Tap <b>Setup</b> to adjust settings for each section control module.</p> <ul style="list-style-type: none"> <li>• Section Control Type: Select the type of section control for each module.</li> <li>• Off When Stopped: When set to Yes the control valve will close when ground speed reaches 0 with the master switch position in On. When set to No the control valve will hold its last position when the master switch is shut off and ground speed reaches 0—if the vehicle is a clutch-operated planter, set this option to No so that you can continue planting when the vehicle is stopped. Otherwise, select Yes.</li> <li>• On Latency: By default, this is set to 0.0 seconds. Use this setting unless you are experiencing a long response time from your clutch or valve (this can happen on larger systems). In this case, increase the On Latency value to compensate the delay, and the system will turn on in advance.</li> <li>• Off Latency: By default, this is set to 0.0 seconds. Use this setting unless you are experiencing a long response time from your clutch or valve (this can happen on larger systems). In this case, increase the Off Latency value to compensate for the delay, and the system will turn off after the set number of seconds.</li> <li>• Start Overlap: Enter the distance of intentional swath overlap when entering a previously applied area. The higher the number, the greater the overlapped area.</li> <li>• End Overlap: Enter the distance of intentional swath overlap when exiting a previously applied area. The higher the number, the greater the overlapped area.</li> <li>• Coverage Switching Overlap: Enter the percentage of the section width for intentional swath overlap. The higher the number, the greater the overlapped area before the section is turned off.</li> <li>• Boundary Switching Overlap: Enter the percentage of the section width for intentional overlap of a boundary. The higher the number, the greater the overlapped area into the boundary area.</li> </ul>

## Rate Control tab

Adjust the rate control settings.

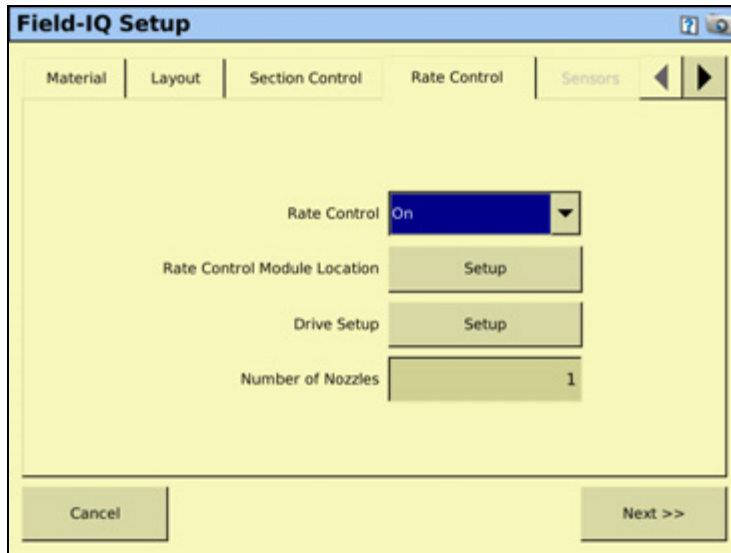

Setting	Description
Rate Control	On: The system sets the target rate. Off: Section switching only
Rate Control Module Location	Tap <b>Setup</b> to configure the rate control module(s), their location on the implement, and the width they will control.
Drive Setup	When you tap <b>Drive Setup</b> , a screen appears with the following tabs: <ul style="list-style-type: none"> <li>• Valve Setup</li> <li>• Feedback Setup</li> <li>• Advanced</li> </ul> The tabs are explained in more detail on the following pages.
Number of Nozzles	Enter the number of spray nozzles on the sprayer.

## Drive Setup

### Valve Setup tab

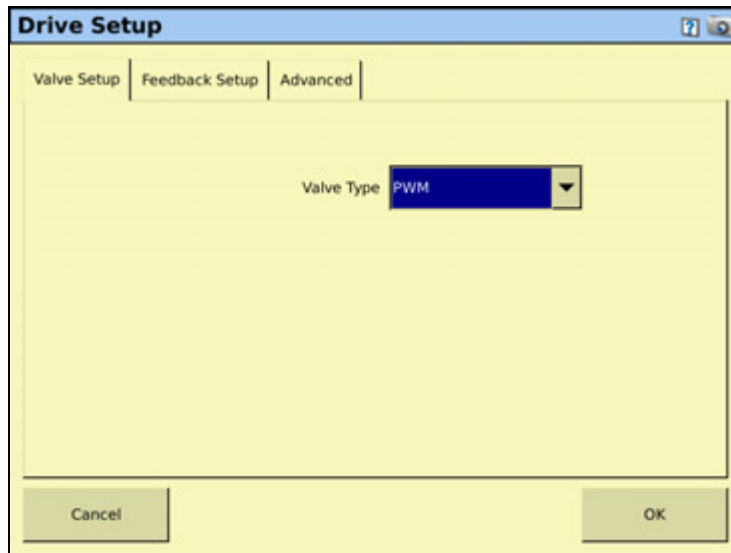

Setting	Description
Valve Type	Servo: 2-wire standard servo valve Fast Servo: 4-wire servo valve PWM: 2-wire PWM valve (commonly used to control hydraulic flow to the pump)

### Feedback Setup tab

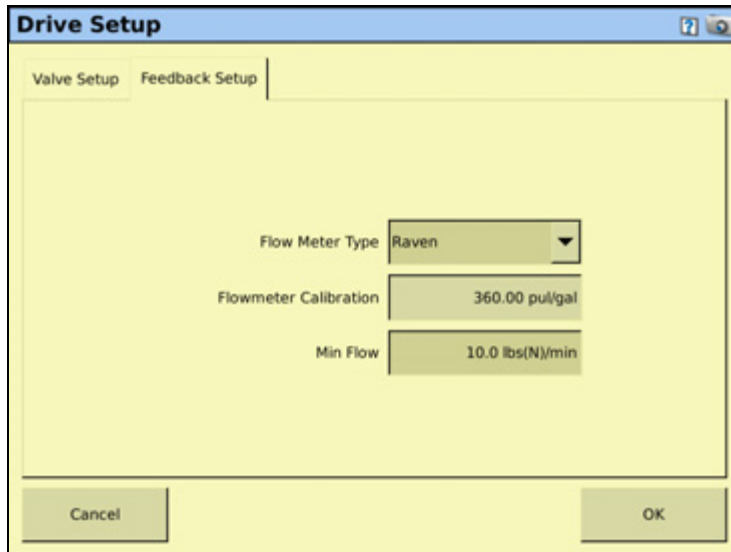

Setting	Description
Flow Meter Type	Select the type of flow meter that is connected.
Flowmeter Calibration	Enter the number from the flow meter tag.
Min Flow	Enter the required minimum flow rate for the system. Use this setting to keep the control valve and flow meter above the minimum operating level.

## Sensors tab

Add or edit sensor settings.

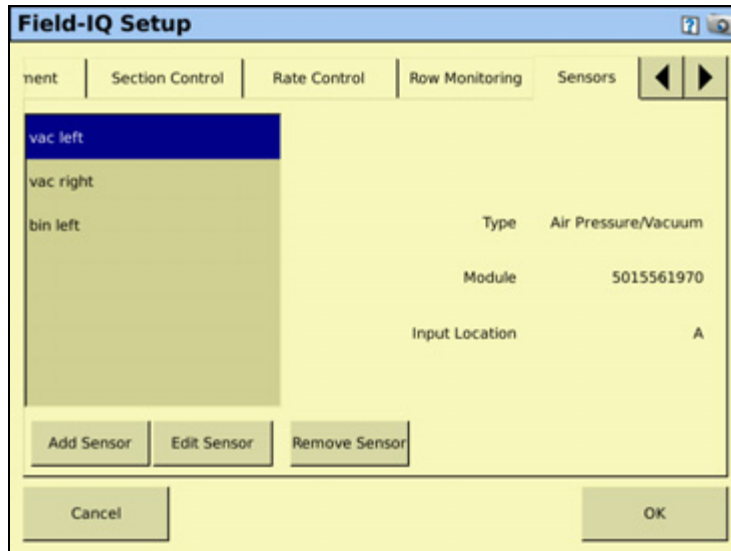

Setting	Description
Add Sensor	Add a new sensor.
Edit Sensor	Edit or view the settings for an existing sensor.
Remove Sensor	Delete an existing sensor.

When adding or editing a sensor, enter the following information:

Setting	Description
Sensor Type	Select from: <ul style="list-style-type: none"> <li>• Air pressure/vacuum</li> <li>• Liquid pressure</li> <li>• NH3 pressure</li> <li>• Bin level</li> <li>• RPM</li> <li>• Gate Height</li> </ul>
Name	Use the virtual keyboard to enter a name for the sensor.
Sensor Setup	Field-IQ module: Select the Field-IQ module that is controlling this sensor. Input location: Specify which wire is controlling the sensor.

## Operation tab

Setting	
Jump Start Speed	This setting controls the speed to be used when the Field-IQ master switchbox Master switch is put in the jump start position. This manual override option can be used to operate the system when the vehicle is stationary. Jump start is also used when GPS has become unavailable.
Shutoff Speed	This setting controls when to shut the system down if the implement drops below the specified speed.
Minimum Override Speed	This setting maintains the application rate when the implement's actual speed drops below the value entered. It is used to ensure consistent material flow during slow speeds.
When Outside Field Boundary	Switch off: The system will not apply outside the boundary area. Operate: The system will apply outside the boundary area.
Material Controlled By	Enabled: The material is tied to the Master Switch Box and cannot be controlled individually. Disabled: The Material is not tied to the Master Switch box and is controlled by virtual buttons on the Run screen.
Rate Snapping	Enabled: Shows the applied rate the same as the target rate, if the applied rate is within 10% of the target rate. Disabled: Shows the actual applied value.

## Material Setup Complete screen

When you have completed setting up a new material, the *Material Setup Complete* screen appears. You can select:

- **Add another material.** You are returned to the start of the *Field-IQ Setup Wizard*.
- **Finish Setup.** You are returned to the *Material Overview* screen.

## Calibrating the implement lift switch

1. From the *Field-IQ Calibration* screen, select the Implement Lift option.
2. Raise the implement and then tap **Next**.
3. Lower the implement and then tap **Next**.
4. Tap **OK** to return to the *Field-IQ Calibration* screen.

## Calibrating the modules



**WARNING** – The anhydrous valve calibration requires the vehicle and implement to be moving and the implement must be in the ground (the implement lift switch must be down). Take all necessary precautions to ensure user safety. Failure to do so may result in serious injury or death.

Calibrate the modules to ensure that your system performs at the level you require.

The *Field-IQ Calibrate* option only appears on the *Configuration* screen if you have at least one Field-IQ Rawson control module or Rate control module set up to control the rate.

1. From the *Configuration* screen, select the Field-IQ plugin and then tap **Calibrate**.
2. From the *Field-IQ Calibration* screen, select the operation under the Module that you would like to calibrate. The message **Not calibrated** appears at the end of the modules that need calibration.

**Note** – If you have an implement lift switch, calibrate it first. See above.

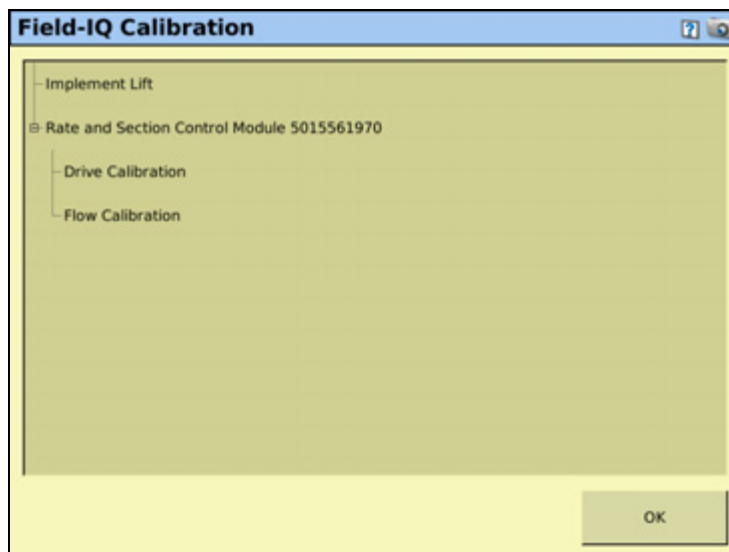

3. Select *Drive Calibration* and then tap **OK**. The *Drive Calibration* screen appears.  
The *Drive Calibration* screen has the following tabs:

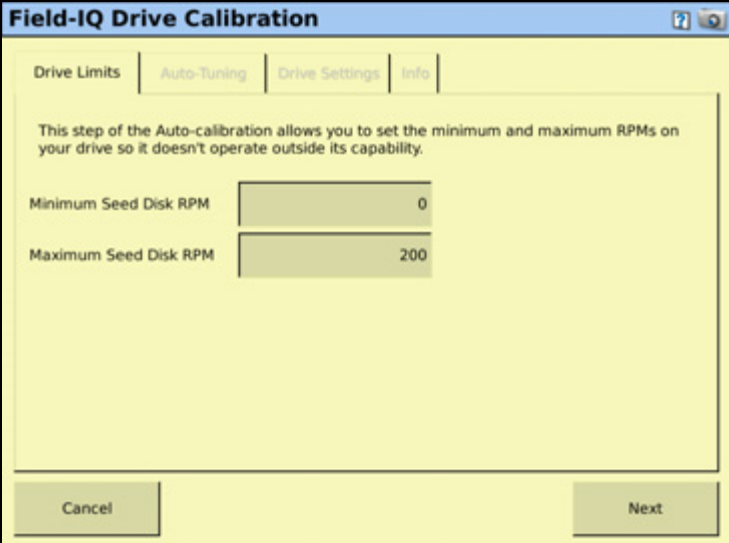
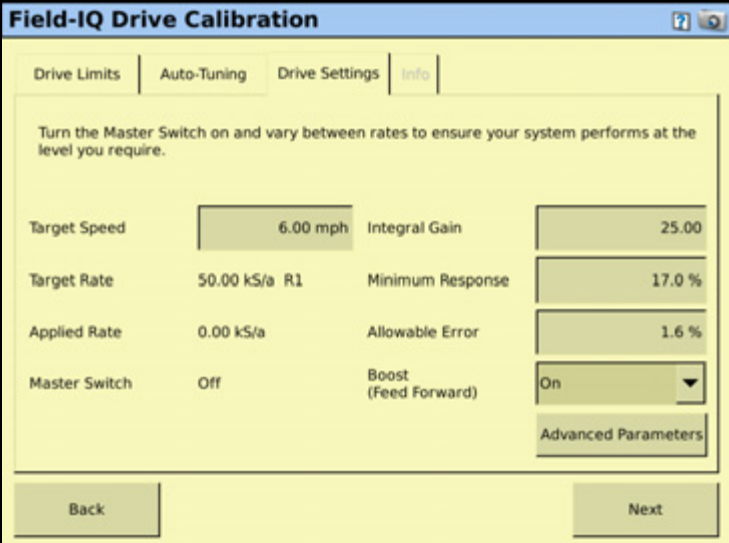
Tab	Description
Drive Limits	<p>Enter the minimum and maximum flow values:</p> 
Drive Settings	<p>Turn the master switch on and vary the rates. Adjust values if needed:</p> 
Info	Shows the results and drive limits of your calibration.

Enter the following values:

- *Allowable Error*
- *Gain*
- *Minimum Response*



**Note** – For information about the appropriate values for your sprayer, refer to the support note *Field-IQ crop Input Control System: For Sprayers and Spreaders*.

4. Select *Flow Calibration* and then tap **OK**. The *Flow Calibration* screen appears.
5. In the *Rate and Section Control Flow Calibration* screen, enter the *Flow Meter* type, the *Flow Meter Calibration*, and the *Minimum Flow*:

6. Tap **Run Calibration** and then follow the on-screen instructions.

## Operating in the field

1. From the Home screen, tap .
2. From the *Current Configurations* screen, configure the display/vehicle/ implement settings and then tap **OK**.
3. From the *Field Selection* screen, select the required client/farm/field/event settings and then tap **OK**.

## Using the Diagnostics tab

1. Select the *Field-IQ plugin* tab and then tap **Diagnostics**. The following screen appears:

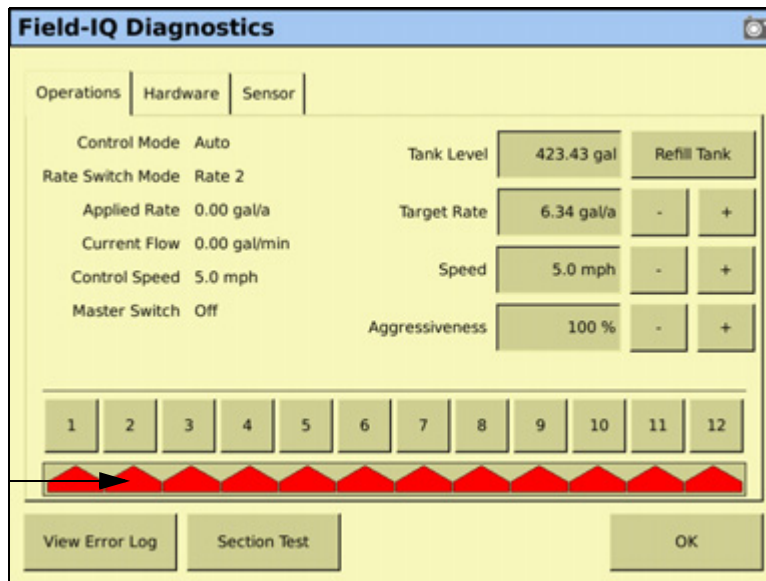

2. To enable the sections, tap the numbered section tabs above each of the section icons.
3. The *Operations* tab displays the current status of:
  - Control Mode (Auto or Manual)
  - Rate Switch Mode (Manual, Rate 1, or Rate 2)
  - Master Switch (Off, On, or Jump Start)

This screen also enables you to manually enter values for:

- *Tank Level*: Enter a new value or select Refill Tank.
- *Target Rate*: The required rate for the rate switch. Decrease or increase.
- *Speed*: Decrease or increase.
- *Switches*: If you are using the optional Field-IQ individual section switch box, this screen indicates which switches have been assigned to each section. To test this, flip each switch in the section switch box. The section it is assigned to appears gray.
- **View Error Log**: Shows all the errors that have occurred since the error log was cleared.
- **Section Test**: The system begins a sequence of engaging each section and groups of sections.

- Operate the sprayer, and check the value shown for the *Applied Rate*. If necessary, adjust the *Aggressiveness* setting to achieve the desired rate.

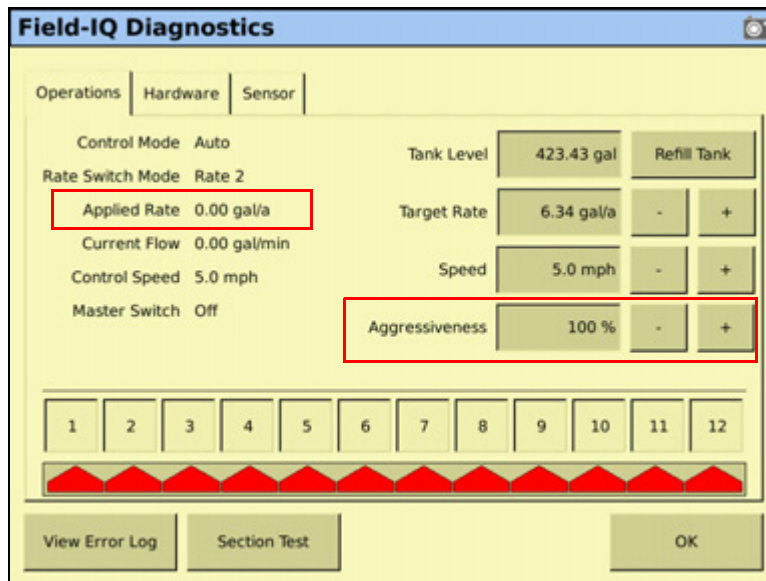

The *Hardware* tab displays the connected Field-IQ CAN modules and the following attributes:

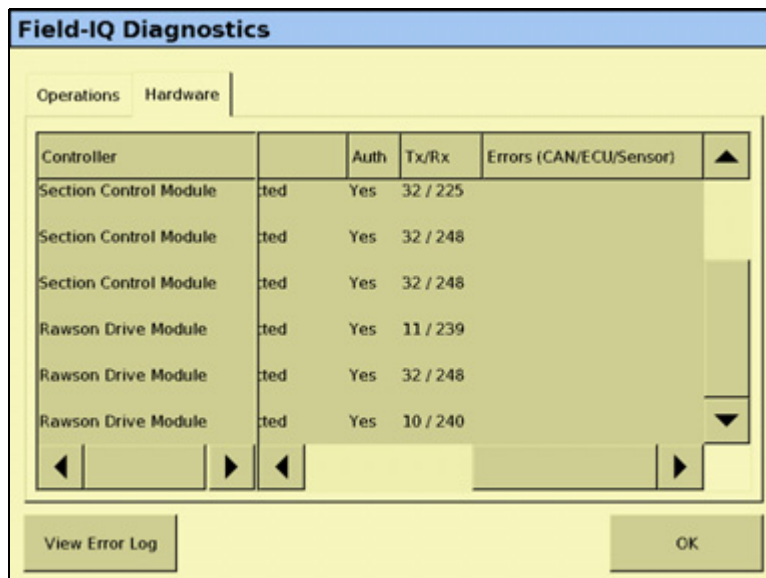

- Serial number
- Position on the implement
- Firmware version
- Status of CAN connection
- Tx/Rx number of packets



# The GreenSeeker Plugin

## In this chapter:

- Introduction
- GreenSeeker primary components
- Care and maintenance
- Field preparations for Nitrogen application
- Operating the GreenSeeker Plugin
- Application information
- Best practice

This chapter describes how to configure and operate the GreenSeeker RT200 variable rate and mapping system plugin on the FmX integrated display.

## Introduction

The GreenSeeker RT200 Variable Rate Application and Mapping System is a tool for variably applying agricultural chemicals based on real-time measurements of the crop. The sensors measure normalized difference vegetation index (NDVI) of the plants while traversing the field.

The applicator provides the ability to variably apply agricultural chemicals in real-time, as the applicator passes over the crop. The NDVI-based variable rate algorithm and parameters may be selected in the field, and all rate changes are then made "on the go," so there are no lengthy delays between evaluating the crop and application. When applying fertilizer or other material, the NDVI, the target rate, and the applied rate are logged. Some rate controllers connected via serial cable to the FmX do not respond with an 'As Applied' value.

The RT200 GreenSeeker sensors emits light at two specific wavelengths and measures the reflected light. The microprocessor in the sensor analyzes the reflected light and calculates the resulting Index value. The data from each sensor is collected by the Interface Module which is processed, and then transmitted to the FmX integrated display in the cab.

The FmX integrated display displays the NDVI in real-time, and sends the appropriate rates to the applicator's rate controller. The rate controller may be an "internal" plug in to the FmX integrated display such as the Field-IQ system. Alternatively, the application rates may also be sent via the Serial Rate Control option as a system plugin.

## Definitions

The following terms occur throughout this chapter, and on the GreenSeeker plugin software. Becoming familiar with the terms will make using the GreenSeeker plugin much easier.

Term	Definition
GDD	<b>Growing Degree Days.</b> A measurement of heat units since planting above a prescribed base temperature.
N	<b>Nitrogen fertilizer</b>
NVDI	<b>Normalized Difference Vegetation Index.</b> Commonly used to measure plant health and vigor. $NDVI = (NIR\_reflected - Red\_reflected) / (NIR\_reflected + Red\_reflected)$ .
NUE	<b>Nitrogen Use Efficiency.</b> A percentage of nitrogen taken up by the plant. For example, an NUE of 60% means that 6 lbs. of nitrogen fertilizer is expected to be used by the plant that year for every 10 lbs. applied. For more information, go to <a href="http://www.nue.okstate.edu">www.nue.okstate.edu</a> .
NRS	<b>Nitrogen Rich Strip.</b> This reference strip/area allows for determining the amount of nitrogen being made available to the plant by the environment (mineralization, etc), and importantly this year's expected maximum yield potential and response to additional nitrogen.
RI	<b>Response Index.</b> Provides an indication of how the crop will respond this season to additional N
VI	<b>Vegetation Index.</b> A value that is calculated (or derived) from sets of remotely-sensed data that is used to quantify plant health, stress, and vigor.
VRA	<b>Variable Rate Application.</b> Based on information supplied to a rate controller, the rate of fertilizer or other chemical applied.

## GreenSeeker primary components

### GreenSeeker RT200 with FmX integrated display components

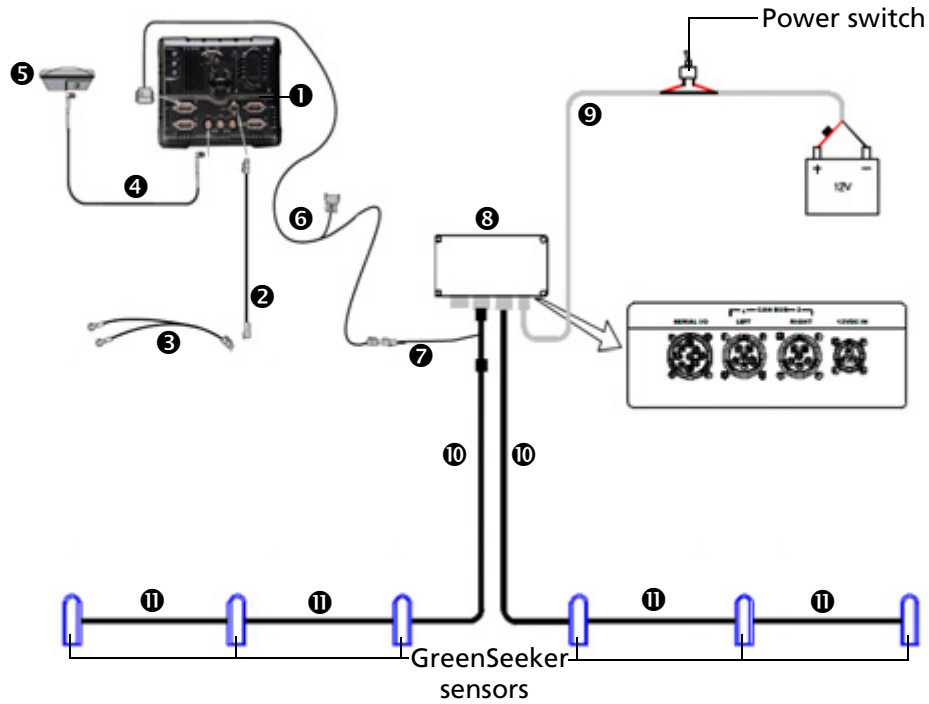

Item	Description	Trimble part number
①	FmX integrated display	93100-01
②	FmX power cable	66694
③	FmX basic power cable	67258
④	8 m GPS TNC/TNC RT angle cable	50449
⑤	AG25 GNSS antenna	68040-005
⑥	FMX / FM-1000 to CAN w/port replicator cable	75407
⑦	GreenSeeker to display cable	77704
⑧	RT200 interface module	900-1-047
⑨	30' RT200 power cable	400-1-276
⑩	20' RT200 interface module cable	400-1-277
⑪	20' RT200 sensor cable	400-1-265-240

## Interface module

The Interface Module contains circuitry to interface boom mounted sensors with the FmX integrated display. The interface module has CAN, serial, and power connections.

The module is an environmentally sealed enclosure which can be installed inside or outside the cab.



## GreenSeeker sensors

Reflectance readings are taken by the sensor. These units generate their own illumination for use in any lighting condition, day or night.

When the unit is on, a red band of light will be observed directly below the rectangular sensor window. The sensor is designed for an optimal height of 28" – 48" over the plant/crop canopy to be sensed. The field of view (width of the sensor measurement) is approximately 24" within the sensor's optimal height range.



## Sensor mounting bracket

Sensors are typically mounted to a standard stainless steel bracket supplied by Trimble. These brackets are designed to fit most boom structures, and are typically mounted with U-bolts.





## Care and maintenance

To maintain the high performance of your GreenSeeker RT200 variable rate application and mapping system, do the following:

- Each day, or during applicator re-fill, check the GreenSeeker sensor detector and light source windows for dust and dirt, and wipe clean with a soft rag.
- The GreenSeeker system should not be left outdoors during extreme weather conditions. Wide temperature variations are hard on electronics and fluid seals, and may reduce the operating life of the system.
- DO NOT store a GreenSeeker system with the sensors facing upward. Doing so may allow water to collect around the windows and gaskets, causing seal failures in those areas. Also direct sunlight can in some cases focus enough energy into the sensor to damage the detector.

*Note – There are no field serviceable components of the electronic system; do not attempt any field repair of a malfunctioning interface module or sensors. If you experience operating problems, contact your local dealer or Trimble representative.*

## Field preparations for Nitrogen application

*Note – The following instructions apply to the most common Nitrogen applications. Check algorithms for specific instructions. For updated specific algorithm instructions, go to [www.GreenSeeker.com](http://www.GreenSeeker.com).*

### Field information

Before the GreenSeeker applicator can be utilized to apply nitrogen (N) across a field, a nitrogen rich reference strip (NRS), or "calibration" area must be established prior to or shortly after planting. This reference strip is used to determine the amount of nitrogen being made available to the plant by the environment (mineralization, etc) and importantly, this year's expected maximum yield potential and response to additional nitrogen. The ideal NRS would run the length of the field, but it should at least be 400 feet long.

### Establishing a calibration reference area

Establish the NRS in a representative reference portion of the field (i.e. not in high spot or low spot). The rate of N necessary to establish a NRS is crop and region dependent, and should be equivalent to the highest rate necessary to satisfy crop needs throughout the growing season.

The rest of the field is referred to as the Non-Reference (Non-Ref) portion. It may also be referred to as the N-limited area or farmer practice region.

For best results, the RT200 should be used to "read" the NRS and apply N at growth stages dependent upon the crop algorithm used. For most supplied algorithms this is typically:

- Wheat: Feekes growth stage 4-6
- Corn: V8-V12.

For updated specific algorithm instructions, see [www.GreenSeeker.com](http://www.GreenSeeker.com).

In order for the sensors to accurately determine NDVI for topdressing (or sidedressing), plant coverage should be at least 50%. The RT200 system with RT Commander can use the sensor mounted booms to read the NRS, or the GreenSeeker Hand Held sensor can be used to determine field conditions.

To collect sensor readings for the NRS, the boom mounted sensor (or handheld sensor) should be passed over the crop at 32 – 48" above the canopy. A large area of the NRS and Non-Reference portion of the field should be sensed to accurately determine their respective NDVI values. Once the NDVI values have been measured, they can be entered into the GreenSeeker plugin on the FmX integrated display. (This can be done automatically with the boom mounted sensors, or manually entered if the GreenSeeker hand-held is used).

If the response is variable across the field, select an area where the difference between the Reference and the Non-Reference areas are most apparent. This assures that the algorithm will determine a rate that utilizes the highest yield potential prediction and maximum response to N for that year.

In order to estimate yield potential, most algorithms utilize an environmental factor (Growing Degree Days or Days From Planting), which takes into account the weather and length of time that has passed since planting.

Be aware that different GDD variations are used for different crops, and to obtain the GDD value the planting date and sensing date must be known. Regional values for GDD may be found on the internet.

For more information regarding GDD regional values go to <http://www.ntechindustries.com/software>, and browse to the *Where to Find GDD Information* link.

## Field setup

To prepare a reference area, do the following:

1. If past practice was a 100% pre-plant application of N, decrease pre-plant N application rate of the field to a level at least half of previous total N applied during non GreenSeeker management practice.

For spring or winter wheat, if application rate has historically been 100 lbs N/acre, decrease the rate to 50 lbs N/acre.

For corn, if application rates have historically been 200 lbs N/acre decrease to 75 to 125 lbs N/acre.

For corn or wheat, be aware that a sandy soil type, or heavy rainfall may require additional N application to maintain the NRS as a non-limiting reference area.

2. Prior to, or shortly after planting, establish the NRS (Nitrogen Rich Strip) in a representative portion of the field (i.e. not in a historically high spot or low spot) and then apply an applicators width swath of N. The rate of N applied should be high enough to satisfy crop N needs in a good year.

For spring or winter wheat, the N rate should be at least 100 lbs N/acre.

For corn, the N rate should be at least 200lbs N/acre. Keep in mind that a sandy soil type or heavy rainfall may require additional N application to maintain the NRS as a non-limiting reference area.

3. Make certain to use a permanent land marker or temporary marker to ensure that the NRS can easily be found later in the season. You may also want to establish the location of the NRS by noting it as an A-B line or flag on the FmX integrated display.

The ideal NRS would run the length of the field, but it should at least be 400 feet long.

4. At appropriate crop growth stage, take readings of the NRS and an adjacent part of the field yet to be fertilized. For most supplied algorithms the following is typical:

- Wheat: Feekes growth stage 4-6
- Corn: V8-V12.

5. Find the area where the nitrogen rich strip is most apparent in comparison to the rest of the field (this indicates greatest potential for the crop).
6. Take sensor readings with RT200 or Hand Held sensor for input to your selected Crop Algorithm.
7. Be sure to match nozzles and/or rate control system to maximize response time and performance for each field's requirements.

For more information, see [Delivery System and Liquid Control, page 360](#) for more details, and be sure to consult your application equipment and rate control systems manuals as applicable.

## Field preparations for user defined rate

The RT200 system can be used to apply other materials than Nitrogen. The GreenSeeker plugin for the FmX integrated display permits a custom algorithm to be entered which is a table of product values versus the NDVI value. These values are entered into the *Custom Formula Application* table, see [Defining a Custom Table, page 357](#).

**Note** – *The values in the table are only an example; the grower/consultant must develop these rates. Also be aware of the rate range ability of your specific rate controller and nozzles used to achieve these results.*

### Example of field calibration

The photo shows a grower using a GreenSeeker hand-held to measure the NDVI of a crop the grower knew the approximate desired rate for.

*Note – The NDVI can also be measured using the GreenSeeker RT200 by observing NDVI values on the GreenSeeker Run screen or using the calibration function.*



## Operating the GreenSeeker Plugin

The GreenSeeker system requires the one of the following applications to be active on the FmX integrated display:

- The Field-IQ system
- Serial Rate Control system

Calibrate the GreenSeeker system through the Run screen on the FmX integrated display. Before calibration, you must collect or input reference strip data to the FmX integrated display: Do this with either the boom mounted sensors on the RT200, or with the GreenSeeker hand held sensor prior to application.

If you use the RT200 interface module for variable rate control, you must set up the application equipment and rate controller to match the expected delivery rate commands.

### Preparing the GreenSeeker plugin

To configure variable rate application on the FmX integrated display, do the following:

1. Power up the RT200 interface module and the rate controller (if required).  
The RT200 interface module's green Power LED will blink three times accompanied by three beeps when the unit is first turned on. Following this, the Status LED will blink in time with each transmission of sensor data over the CAN bus. Expect to see a brief green flash, followed by a red flash at the I/M message rate (typically at 0.5sec) - this indicates that data from the left (green flash) and right (red flash) CAN ports is being transmitted.
2. Install the GreenSeeker plugin. For more information, see [Adding or removing a plugin, page 192](#).
3. From the Home screen, load the field to be sprayed.

## GreenSeeker plugin screen

The control items in the GreenSeeker tab on the Run screen depend on what you previously selected, for example, a crop algorithm, or a custom table.

The **Calibration Required** message appears when a new job/event is first opened and a crop algorithm has been previously used or selected.

***Note** – If you want to use a custom table, but see this screen, tap *Edit* and then follow the custom table instructions found in the *FmX Integrated Display User Guide*. If a custom table has been previously selected, the **Calibration Required** message will not display.*

1. From the Run screen, select the GreenSeeker plugin tab:

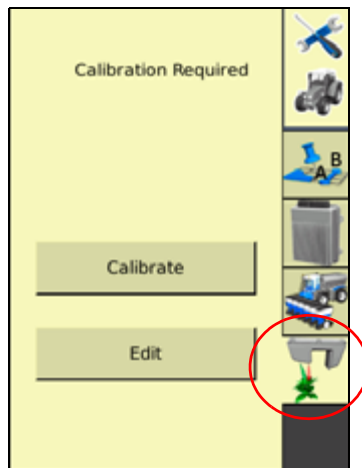

2. Tap **Calibrate**:

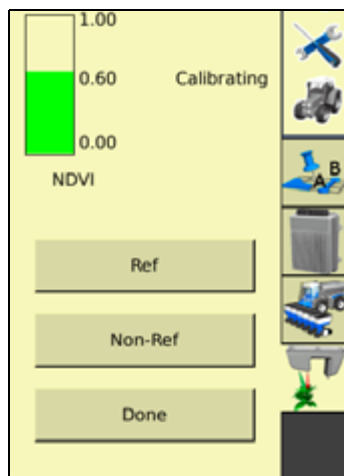

The GreenSeeker plugin tab now includes **Ref** and **Non-Ref** buttons, along with a NDVI bar graph showing the real-time combined average NDVI from the RT200 module.

3. Position the vehicle at the reference locations.
4. To record NDVI data from the reference strip, tap **Ref**, drive the reference strip and then tap **Ref** again to end recording.

- To record NDVI data from the non-reference strip, tap **Non-Ref**, drive the non-reference strip and then tap **Non-Ref** again to end recording.

*Note* – As the NDVI is collected, the data is stored in respective fields on the GreenSeeker calibration page. Keep the vehicle moving as you collect the data; stopping in one location affects the average values. The Ref and Non-Ref buttons change to a lighter color when selected or active.

- Tap **Done**:

The screenshot shows the 'GreenSeeker Calibration' window with four tabs: Calibration, Algorithm, Chart, and Output. The 'Calibration' tab is active, displaying a table with two columns: 'Non-Reference' and 'Reference'. The table contains the following data:

	Non-Reference	Reference
Maximum		0.70
Average	0.60	0.70
Minimum		0.50
Calibrate	Non-Ref	Reference

Below the table, the 'Algorithm Version' is listed as 'NTech RT200 ISO Algorithms: Mar 2009'. At the bottom of the window are 'Cancel' and 'OK' buttons.

You now see the values that were collected in [Step 4](#) and [Step 5](#).

**Notes:**

To collect fresh data from this screen, tap the **Non-Ref** or **Reference** buttons. You will not see the new values until you deselect the respective button.

To manually override or input data, select the various fields and then use the screen keypad.

The Reference values in the Maximum, Average, and Minimum fields are also available for the Auto Calibration function on the Algorithm tab.

7. When you are satisfied with the data, select the *Algorithm* tab:

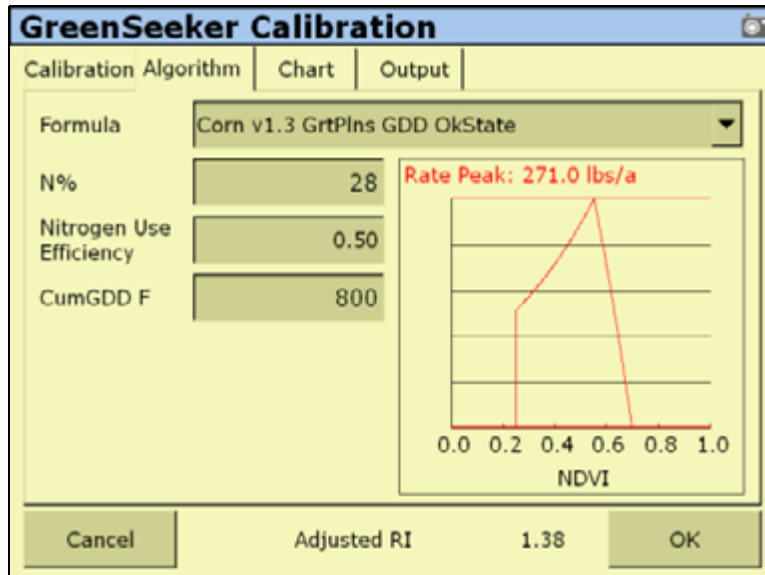

8. Select either an existing algorithm, or Custom Table to create a new algorithm, from the *Formula* list. For more information, see [Defining a Custom Table, page 357](#).

**Note** – The formula selected for your last job will still be current, so you are often just verifying that the correct formula is being used.

9. Input the various fields as required.

The fields displayed will change based upon the formula selected; some fields, such as *Nitrogen Use Efficiency* have default values that are formula specific, but all are able to be changed by selecting the field and using the screen keypad.

**Note** – You may need to reference the specific algorithms instruction for more detailed explanation of the *CumGDD F*, or similar fields. For example the *CumGDD F* for the corn v1.3 GrtPlns GDD OKState is Cumulative Growing Degree Days, Base 50F. For specific algorithm instructions, go to [www.GreenSeeker.com](http://www.GreenSeeker.com).

10. Select the *Chart* tab:

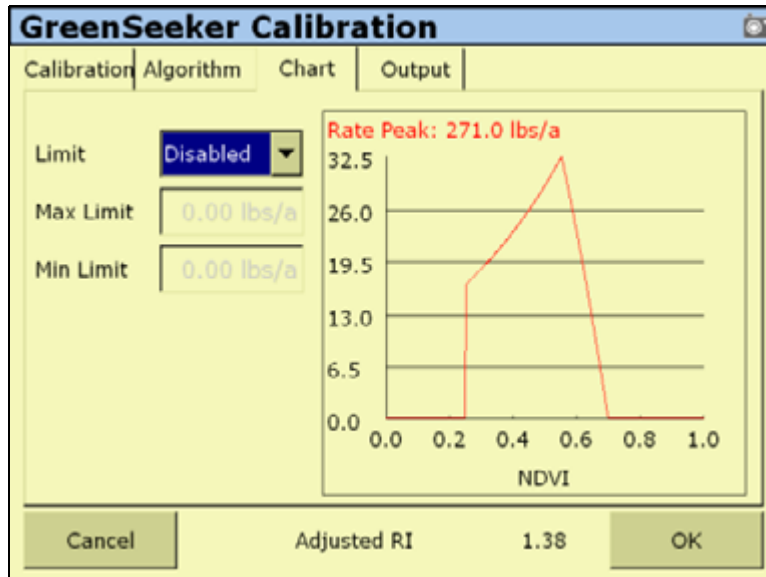

11. In the *Limit* list, select *Enabled* or *Disabled*.
12. If necessary, enter a *Max Limit* value based on rate controller or application equipment limitations.
13. Tap **OK**.
14. Enter a *Min Limit* value.
15. Tap **OK**.

**Note** – *Maximum and minimum settings will limit the rate commands given to the rate controller.*

16. Review the application chart for each job to determine the appropriate nozzle selections and/or application equipment settings.



17. Select the *Output* Tab:

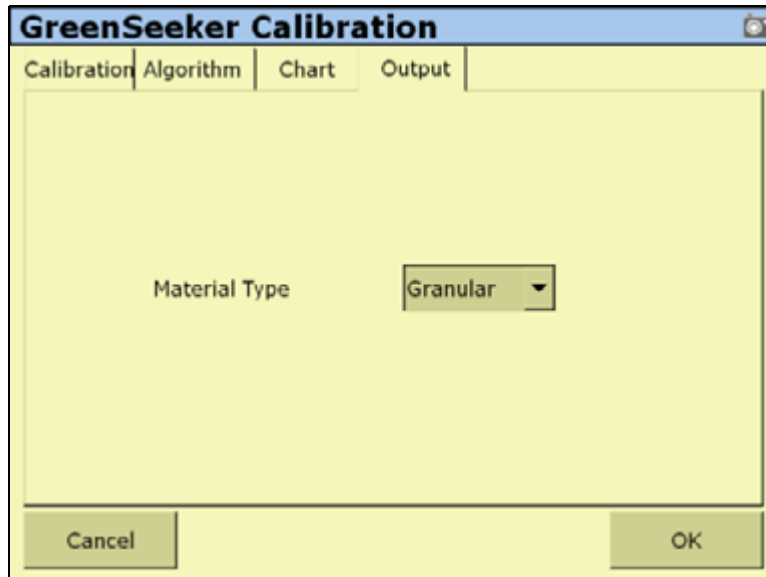

18. In the *Material Type* list, select either Granular, or Liquid.
19. Tap **OK**.

### Defining a Custom Table

For growers or crop consultants, having crop historical knowledge allows them to determine different crop input requirements based upon biomass/size of the crop/plant. An example of this type of use would be variable rate application of defoliant in cotton, or desiccant in potatoes. For these cases, the field is scouted or "field calibrated" to determine areas of the field that require different rates of defoliant.

The RT200 system, or a GreenSeeker hand-held can be used to obtain the NDVI values in representative areas of the field, and then a table can be created with NDVI values corresponding to application rates.

To create a custom table, do the following:

1. From the *GreenSeeker Calibration* screen, select the *Algorithm* tab.

2. In the *Formula* list, select Custom Table or Auto Calibration.

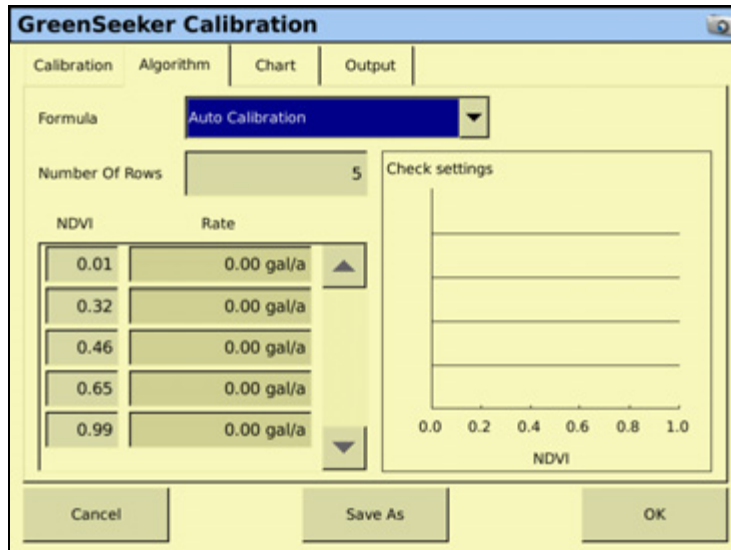

- If you select *Custom Table*, you must enter NDVI calibration values manually. See [Step 3](#).
  - If you select *Auto Calibration*, the system automatically enters NDVI calibration values from the Calibration step by transferring the Maximum, Average, and Minimum NDVI values into rows two, three, and four respectively. Go to [Step 7](#).
3. Select the *Number Of Rows* field.
  4. Use the on-screen keypad to enter a value and then tap **OK**.  
The number of available *NDVI* and *Rate* fields are dictated by the value entered in the *Number Of Rows* field.  
Typically the number of rows for the custom table are two more than the number of filed calibration areas sampled. This allows for starting at zero and ending at .99 NDVI.
  5. Select a *NDVI* field to enter a custom value.
  6. Tap **OK**.
  7. Select a corresponding *Rate* field to enter a custom value.
  8. Tap **OK**.
  9. Select the *Output* tab.
  10. In the *Material Type* list, select either Granular or Liquid.
  11. Tap **OK**.

## GreenSeeker diagnostics

The *GreenSeeker Diagnostics* screen reports on the quantity of sensors detected on system and provides any error conditions.

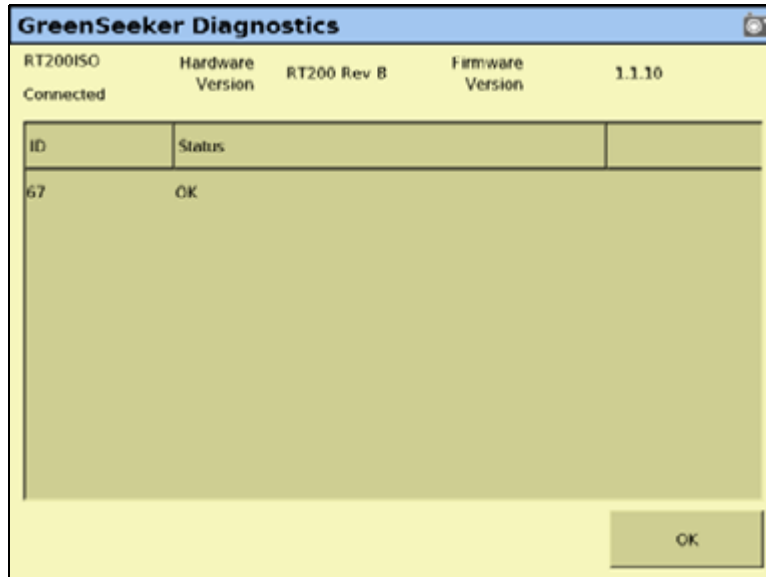

The appearance of both the hardware and firmware version information at the top of the diagnostics screen indicates that the FmX integrated display and RT200 are communicating.

### Erroneous data

The RT200 system monitors the sensors for proper operation, and if a sensor reports erroneous data, the data is not included in the rate control calculation. Erroneous data can come from mud on the sensor lenses, sensors viewing concrete, snow, wet asphalt, or other non soil or non plant surface.

### Error conditions

Error conditions include sensors disconnected from the CAN bus, or a sensor transmitting invalid data.

Invalid data could occur if the sensor malfunctions, or more commonly, if it is seeing a target other than plants and soil. For example, when setting up the system, the sensors may be pointed into the air, or against wet asphalt; either of these will likely generate an error code from a sensor.

Error	Code	Description
-1	Red > NIR	Red reflectance higher than NIR
-2	BOTH < .01	Both reflectances are below 0.01
-3	RED < .01	Red reflectance below 0.01
-4	NIR < .01	NIR reflectance below 0.01

Error	Code	Description
-5	BOTH > .98	Either reflectance above 0.98
-9	NIR < .015	NIR net reflectance below 0.15

To access the GreenSeeker diagnostics, do the following:

1. From the Home screen, tap .
2. In the *Current Configurations* screen, tap **Configure**.
3. From the *Configuration* screen, select the GreenSeeker plugin and then tap **Diagnostics**.

## Application information

### Delivery System and Liquid Control

As with any variable rate system, the minimum and maximum rates obtainable are dependent upon the delivery system. The RT200 interface module is capable of "requesting" any rate, but the actual rates delivered are dependent upon the rate controller and its components. Most liquid rate control systems control or "throttle" the pressure of the system to affect flow and application rate.

When using the RT200 with a typical liquid delivery system, it is important to match nozzle sizes to expected delivery rates. After the appropriate reference strip readings, GDD, and selection of crop type are input into RT Commander, the application graph can be accessed to show the prescription rates at various sensor NDVI readings. Depending upon what delivery system is used, there will be actual minimum and maximum rates obtainable. These will be dependent upon components like the pump, control valve, nozzles, and boom plumbing sizes.

The GreenSeeker plugin for the FmX integrated display has features that allow for minimum and maximum rates to be set, regardless of the crop algorithm prescription. Once a nozzle set is chosen, the minimum should be set at the lowest rate the nozzles will still give adequate pattern/performance. Maximum rates may be limited by rates that lessen atomization or drift.

## Selecting a nozzle

It is usually best to match nozzles to the lower midrange of the typical rates shown on the application graph. Ultimately, it is up to the grower or crop consultant to determine the minimum or maximum rates and nozzles which are most appropriate. For example:

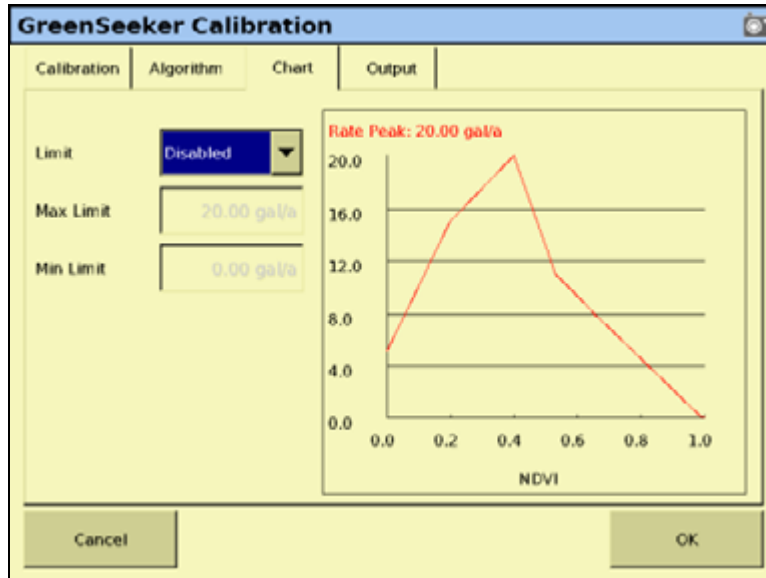

If most of your NDVI readings (in the area of the field not in the NRS) are around 0.53, and your review the application graph shows at 0.53 NDVI you should be applying 15GPA, then you should choose a nozzle that will have the ability to change rates above and below this NDVI reading. You might choose a nozzle that puts out 12.5GPA at its lowest pressure (e.g. 20psi) and 21GPA at its highest pressure (e.g. 60psi). Since the penalty to under-fertilize (harm yield) is usually greater than to over-fertilize (waste fertilizer), it may be best to choose a strategy similar to the one shown here. You will need to modify your values to fit your circumstances and meet the local field and delivery system conditions.

## Best practice

To ensure best performance from the GreenSeeker variable application system, do the following:

- Do not use high pressure spray on the sensors when rinsing the machine. Even though all of the connectors and modules are fully sealed, there is the potential of leakage from a pressurized stream.
- Every time the spray tank is filled, take a soft cloth and wipe the lenses of the sensors. Try to check sensors at least once a day during full time operation.
- Be more aware of cleaning the sensors directly behind the machine.
- If you do not have ground protection devices on the boom, such as gauge wheels or skids, take extra care to not run the boom into the ground. Also, be aware of sensor vulnerability to stationary structures in the field.

Sensors are usually mounted on the front of the boom and do not have rigid protection.

- Rinse the boom at the end of every day. Do this to keep the system clean and remove to any corrosive materials. Doing so will greatly extend the life of your machine.
- Sensors should be re-calibrated after approximately 1000 hours of use due to possible changes in light output. This is generally done at the factory, or authorized service center.
- Sensors have an optimum operating range of 32" - 48" above the crop canopy. 38" is the optimum height, and must be measured from the top of the crop to the rectangular LED window of the sensor.
- Make sure all wiring harness components remain fastened to the boom as to not obstruct the view of the sensors and are free of any pinch points from boom folding and movement.

# The TrueGuide Plugin

## In this chapter:

- Connecting the TrueGuide implement guidance system
- Configuring the TrueGuide implement guidance system
- Calibrating the TrueGuide implement guidance system

This chapter describes how to configure the TrueGuide™ implement guidance plugin to work with the FmX integrated display.

*Note – Firmware version 2.0 or later of the FmX integrated display and the NavController II firmware version 5.10 are required for TrueGuide implement guidance.*

The TrueGuide plugin for the Autopilot automated steering system and the FmX integrated display supports a second GPS receiver (an FmX internal or external AgGPS receiver) on the implement that is used to measure the position of the implement so that the Autopilot system can adjust the position of the tractor to pull the implement on line.

The TrueGuide system supports towed implements for front-steered, tracked, and articulated tractors..

To achieve the highest performance from TrueGuide implement guidance, the Autopilot system on the tractor must have a good calibration. An Autopilot system that is calibrated very aggressively may need to be set up with a more neutral calibration when used with TrueGuide implement guidance.

## Connecting the TrueGuide implement guidance system

Once the TrueGuide implement guidance system has been professionally installed, add the FmX integrated display as shown:

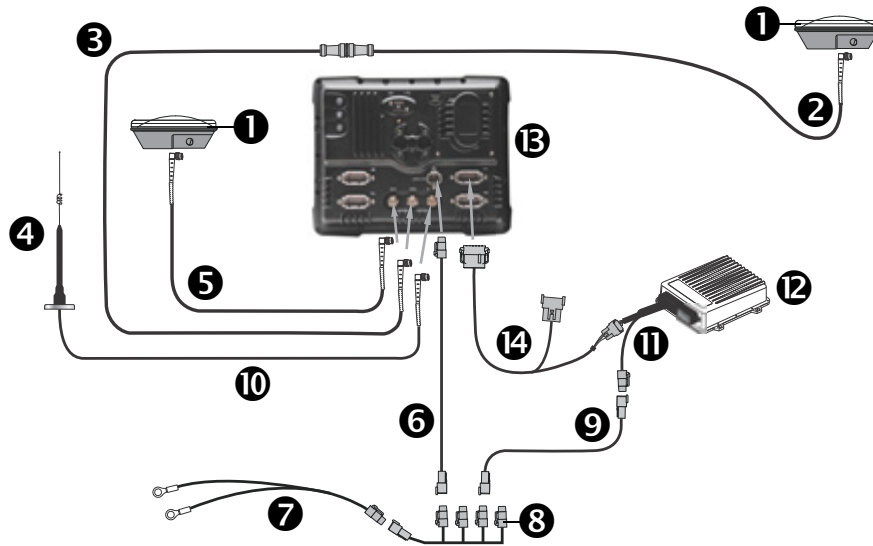

**CAUTION** – Connecting the Port Replicator on the FmX to NavController II cable ⑭ to the P4 or P12 connector of the NavController II harness ⑩ will result in damage to the FmX integrated display, and will void the warranty.

Item	Description	Trimble part number
①	A25 GNSS antenna (x2)	68040-005
②	LMR400 65" extension cable	67473
③	Coaxial cable	68295
④	Antenna	2822-10
⑤	Right-angle cable	50499
⑥	FmX power cable	66694
⑦	Basic power cable	67258
⑧	Main power bus cable	67259
⑨	Power adaptor cable	67095
⑩	NMO to TNC 20' antenna cable and base	62120
⑪	Main NavController II cable	54601
⑫	NavController II	55563-00
⑬	FmX integrated display	93100-02
⑭	FmX to NavController II cable with port replicator	75741



## Configuring the TrueGuide implement guidance system

TrueGuide implement guidance must have:

- The Autopilot automated steering system installed on the tractor. For instructions on how to install the Autopilot system, see the *Autopilot Automated Steering System Installation Instructions* relevant to your vehicle.
- Stable implements. Implements that are unstable, such as sprayers with large flotation tires, will cause rocking in the antenna that will be greater than the performance improvements on the ground.
- Both the Autopilot option and the TrueGuide plugin activated on the FmX integrated display. For more information see [Adding or removing a plugin, page 192](#)).

### TrueGuide implement setup

Before using the FmX integrated display with the TrueGuide system plugin, select and configure a new or existing implement. For more information, see [Chapter 7, Implement Configuration](#).

**Note** – You can update existing (saved) implements with implement geometry to support TrueGuide implement guidance.

**Note** – Antenna offsets are provided when the antenna cannot be placed directly over the working point of the implement. These offsets should be minimized whenever possible.

Settings on the *Geometry* tab are required for implement modelling. When configuring an implement for the TrueGuide system, the following antenna offsets are required:

Offset	Description
Hitch to ground contact point	Measured from the tractor hitch pin to the soil engagement point that the implement rotates around.
Antenna front/back	Measured from the implement working point to the center of the GPS antenna (if mounted).
Antenna left/right	Measured from the center of the implement to the center of the GPS antenna (if mounted)
Antenna height	The working height of the GPS antenna

## Setting up the TrueGuide system

- From the *Configuration* screen, select the TrueGuide plugin and then tap **Setup**:

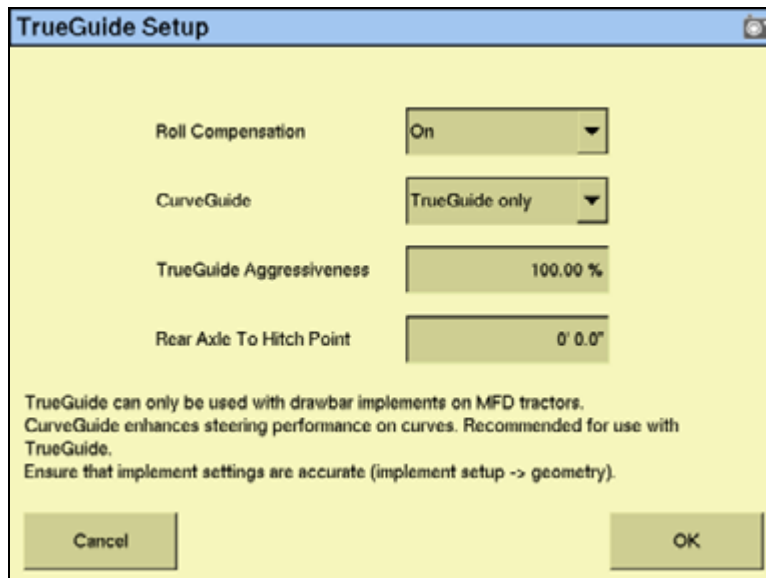

- Enter the required global settings:

Setting	Description
Roll compensation	<ul style="list-style-type: none"> <li>On: Applies roll corrections from the tractor.</li> <li>Off: Applies no roll corrections.</li> </ul>
CurveGuide	<ul style="list-style-type: none"> <li>Off: The system does not anticipate curves.</li> <li>TrueGuide only: Enables the system to anticipate curves to make corrections for TrueGuide guidance only.</li> <li>Always On: Keeps CurveGuide on at all times.</li> </ul>
TrueGuide Aggressiveness	Sets the default aggressiveness; the recommended aggressiveness is 100%. For more information, see <a href="#">TrueGuide system aggressiveness settings, page 371</a> .
Rear axle to hitch point	Enter the distance between the fixed axle for conventional tractors, or the center of rotation for tracked tractors, and the draw bar.

- Tap **OK**. The *Configuration* screen appears.

## Calibrating the TrueGuide implement guidance system

To calibrate the TrueGuide system, you must have a field open in the Run screen with an AB line configured. For more information on opening a field and creating an AB line, see [Introduction to field features, page 40](#)

From the Run screen, do the following:

1. Tap . Without closing the field, the *Configuration* screen appears.

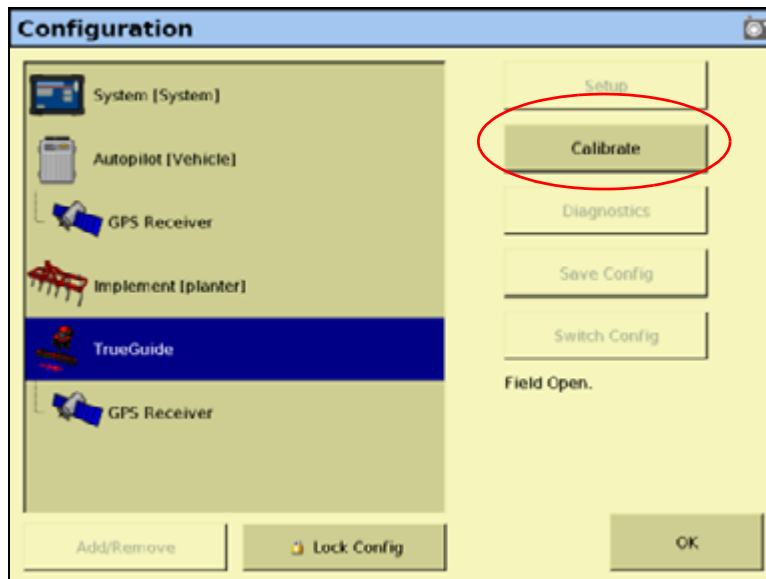

2. Select the TrueGuide plugin and then tap **Calibrate**.
3. In the *TrueGuide Calibration* screen, tap **Next** and then follow the on-screen instructions:

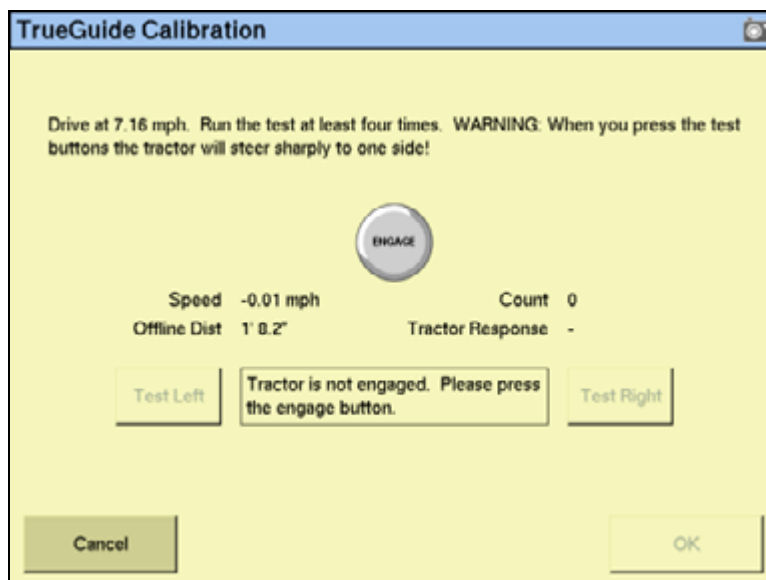

- Complete the test at least four times and then tap **OK**:

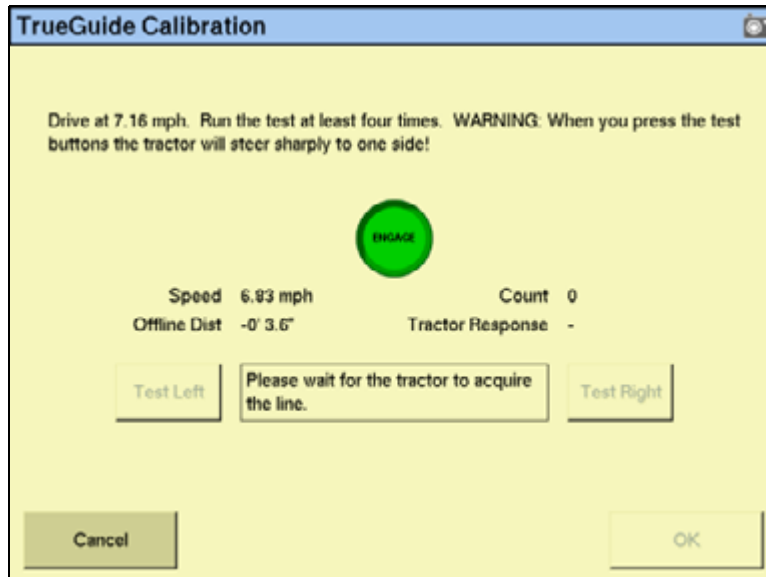

- In the *Calibration* screen, tap **OK** to return to the open field.

## Engaging and disengaging the TrueGuide system

To engage the Autopilot and the TrueGuide systems using the FmX integrated display, you must have a guidance line defined and the vehicle must be within the engage limits of the system.

To manually engage the systems, do one of the following:

- Tap the **Engage** button on the main guidance screen.
- Press the optional remote engage foot pedal or rocker switch.







To disengage the systems, do one of the following:

- Tap the **Engage** button on the main guidance screen.
- Press the optional remote engage foot pedal or rocker switch.
- Turn the steering wheel.

The system automatically disengages when:

- The vehicle or implement is outside the engage limits.
- GPS positions are lost on the implement or on the vehicle.
- Minimum Fix Quality* is not maintained and the system receives low accuracy positions (for example, no corrections).

### Engage status indicators

Engage status	Button color	Vehicle icon color
Ready to engage		
Engaged		
Cannot engaged		

### Operating the TrueGuide system

1. In the Run screen, with the *TrueGuide* tab showing, tap **AUTO**:

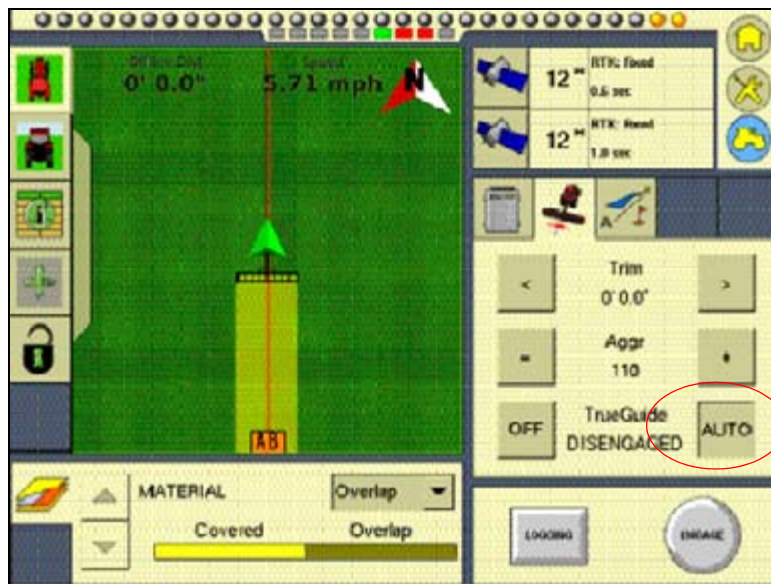

The TrueGuide system status is shown as Disengaged.

2. Tap **Engage** to start guidance. The **Auto** button changes to **ON** and the TrueGuide system status is shown as **Waiting**:

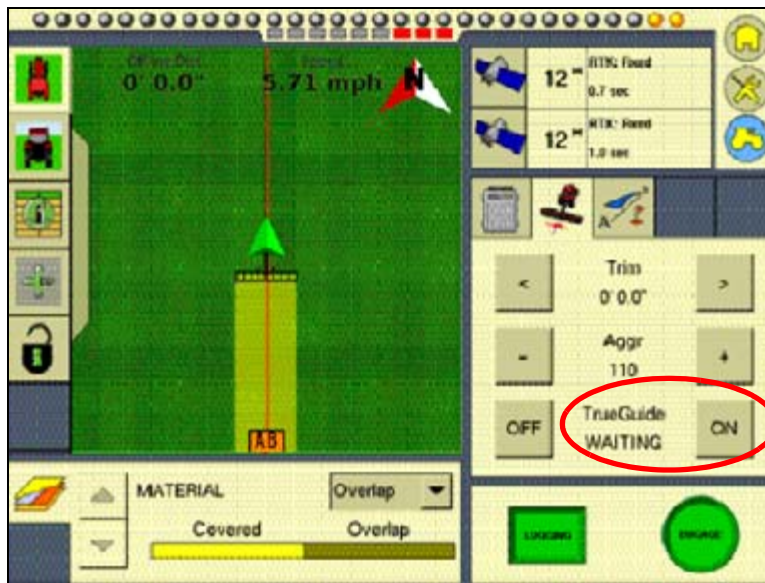

The Autopilot system acquires the line before transitioning to the TrueGuide system. The TrueGuide system status remains at **Waiting** while the Autopilot system acquires the line. Once the TrueGuide system has taken control, the TrueGuide System status changes to **ON** and the TrueGuide system Engage button changes to **Auto**:

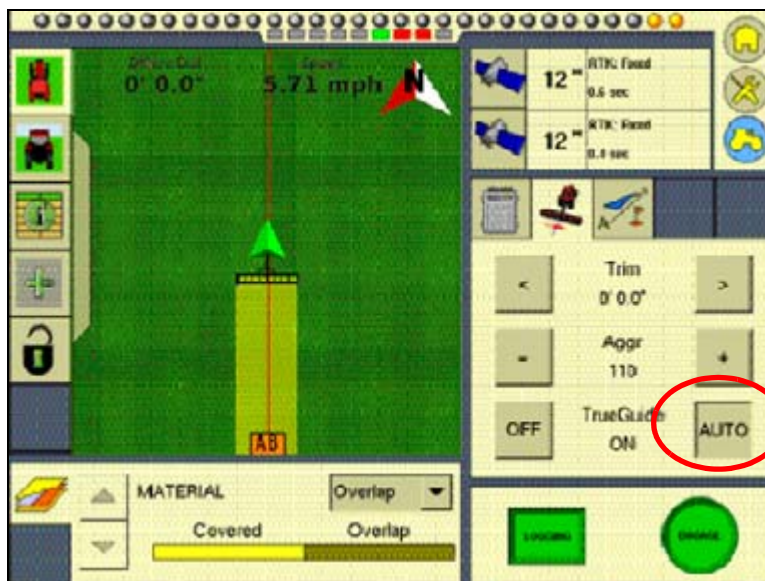

3. To disengage the TrueGuide system at any time, tap **Off**.

*Note* – To force the TrueGuide system to turn on when the status is **Waiting**, tap **ON** again.

*Note* – As soon as the TrueGuide system is disengaged, the Autopilot system immediately begins providing all guidance.

## TrueGuide system status indicators

The system status appears on the *TrueGuide* tab between the **Off / On (Auto)** buttons.

TrueGuide status	Description
Off	The TrueGuide system is off.
Disengaged	The TrueGuide system is ready, but not engaged.
Waiting	The Autopilot system is engaged, and the TrueGuide system is preparing to engage after a short pause.
On	The TrueGuide system has engaged and is on.

## TrueGuide system aggressiveness settings

To set the default aggressiveness value, see [Setting up the TrueGuide system, page 366](#).

- Increasing the aggressiveness increases the response to move the implement back to the guidance line.
- Decreasing aggressiveness smooths the response to the implement moving offline.

For...	Use as default...
Steep slopes (10%– +30%)	150%
Slow-speed applications	125%
Normal operation	100%
High-speed applications (>8 MPH)	33%

## Adjusting aggressiveness during operation

1. From the Run screen, select the TrueGuide Plugin:



2. Do one of the following:
  - To increase aggressiveness, tap +.
  - To decrease aggressiveness, tap -.





## The TrueTracker Plugin

### In this chapter:

- [About the TrueTracker system](#)
- [Configuration](#)
- [Using the TrueTracker system](#)

One of the FmX integrated display features that can be unlocked is the TrueTracker implement steering system.

This chapter describes the TrueTracker system and how to configure it to steer implements more accurately.

## About the TrueTracker system

The TrueTracker implement steering system is an upgrade for the Autopilot automated steering system. With the Autopilot system, the vehicle receives guidance and pulls the implement. When the TrueTracker system is added to the Autopilot system, the implement receives separate guidance and steering to increase accuracy.

The system comprises two parts:

- Additional hardware installed on the implement
- Additional FmX integrated display software provided by the TrueTracker plugin

The TrueTracker system extends the sub-inch, year-to-year repeatable accuracy of the Autopilot automated steering system to the implement.

## Terminology

The term *implement steering* refers to the ability to actively steer the implement that a vehicle is towing.

Normally, it is not possible to tell the exact location of the implement. When you use the FmX integrated display with the Autopilot automated steering system for sub-inch accuracy, the GPS antenna and receiver are mounted on the vehicle, and it is the vehicle that is guided.

On flat ground the implement will probably be directly behind the vehicle, but in the following conditions the implement can pull (*draft*) to one side:

- On side slopes
- In variable soil conditions
- On curved guidance patterns

The stand-alone Autopilot automated steering system has no way to detect or correct for implement draft:



In these conditions, the draft distance can be significant enough to lose repeatability for successive field operations despite the  $\pm 25$  mm ( $\pm 1$  inch) accuracy of the tractor equipped with the Autopilot system.

## Benefits of the TrueTracker system

The TrueTracker implement steering system is an optional upgrade for the Autopilot system. You must unlock and install the second FmX integrated display's internal receiver on the implement. Using the Trimble T3™ inertial terrain compensation technology and the accuracy of the receiver, the TrueTracker system can steer the implement, ensuring it remains online behind the vehicle even on extremely sloped ground.

The TrueTracker system supports the following:

- Steering in reverse
- Straight and curved guidance patterns
- Independent implement offset
- Independent aggressiveness control for the implement
- Zero steering to center the coulters

## Requirements of the TrueTracker system

- An Autopilot system with the FmX integrated display
- An unlock code for the FmX integrated display implement steering functionality

## Installing the TrueTracker system

The TrueTracker system requires professional installation. For more information, contact your local Trimble reseller.

## Configuration

To configure the TrueTracker system, complete the following steps:

1. Activate the system. See [page 376](#).
2. Configure the implement settings. See [page 376](#).
3. Configure the implement controller. See [page 379](#).
4. Configure the implement. See [page 381](#).
5. Calibrate the implement. See [page 382](#).

## Activating the TrueTracker system

Before you can use the TrueTracker system, you must activate it on the FmX integrated display. For step-by-step instructions, see [Entering the password to activate a plugin](#), page 193.

*Note* – This process requires you to enter the activation password. If you do not have an activation password, contact your local Trimble reseller.

## Configuring the implement settings

1. From the Home screen, tap .
2. Tap the implement **Edit** button.
3. In the *Configuration Selection* screen, ensure that the Autopilot option and the TrueTracker plugin are both installed. See [Adding or removing a plugin](#), page 192.
4. On the *Configuration* screen, select the TrueTracker plugin and then tap **Setup**.

## Configuring the Vehicle tab

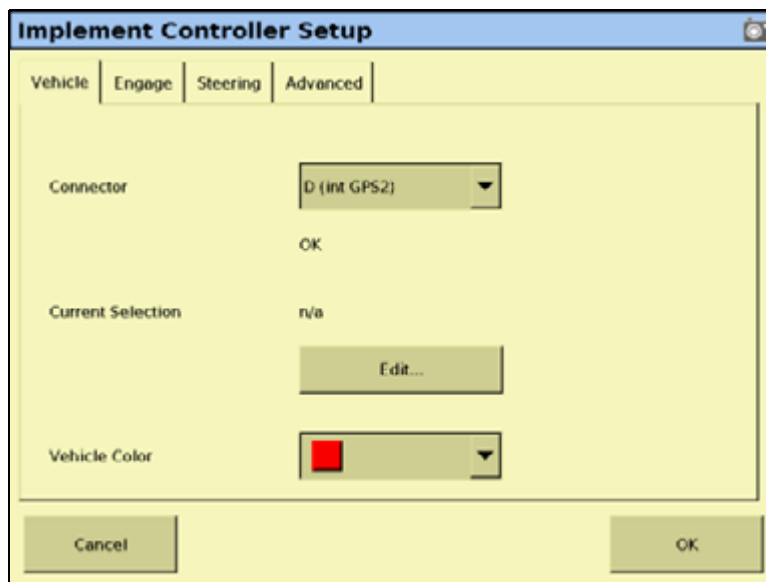

1. From the *Connector* list, select the port that the TrueTracker implement controller is connected to.
2. For the *Current Selection* list, tap **Edit** to change the vehicle profile location and implement model, see [Configuring the implement make and model](#), page 379.
3. From the *Vehicle Color* list, select the color you wish your vehicle to appear on the display screen.
4. Select the *Engage* tab.

## Configuring the Engage tab

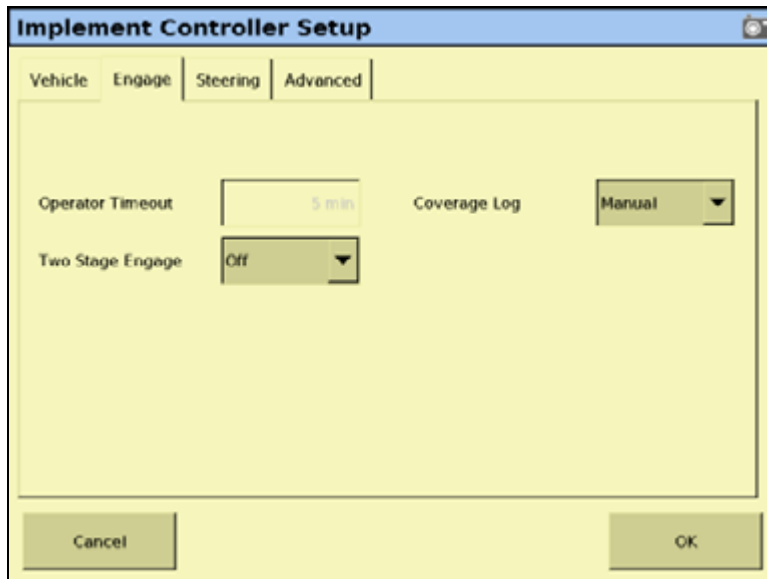

1. In the *Engage* tab, adjust the *Operator Alert Timeout* value.  
The alert appears if the operator does not respond within the defined period of time. If the operator still fails to respond, the vehicle begins to drive in a tight loop.
2. Set the *Two Stage Engage* status:

Item	Description
On	The <b>Engage</b> button requires multiple taps to engage: <ul style="list-style-type: none"> <li>• The first tap engages implement steering</li> <li>• The second tap engages the vehicle steering</li> <li>• The third tap disengages both implement and vehicle steering</li> </ul>
Off	The <b>Engage</b> button engages with one tap: <ul style="list-style-type: none"> <li>• The first tap engages implement and vehicle steering</li> <li>• The second tap disengages both implement and vehicle steering</li> </ul>

3. In the *Coverage Log* list, select either Manual or When Engaged.
4. Select the *Steering* tab.

## Configuring the Steering tab

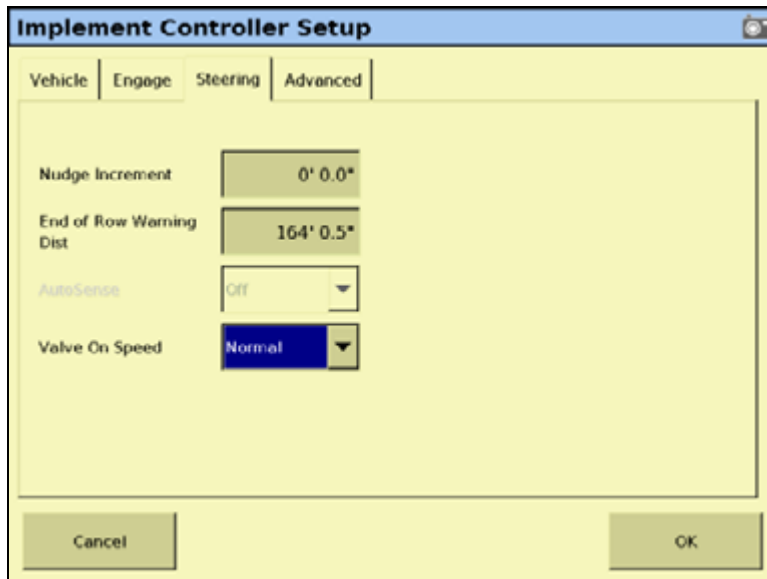

1. In the *Steering* tab, enter a value in the *Nudge Increment* field.

Use this increment to set the amount by which the **Nudge** buttons move the line back to the correct path, or by which the **Trim** buttons move the vehicle position.

The guidance line can move off target (requiring **Nudge**) as a result of:

- GPS position drift when you return to the field for guidance, for example after you pause or turn off the system.
- GPS satellite constellation changes as you drive in the field.

The vehicle can steer offline (requiring **Trim**) as a result of:

- Uneven drag on a vehicle from an unbalanced implement.
- Uneven drag on a vehicle from soil conditions.

**Note** – The **Nudge** buttons become **Trim** buttons in RTK mode.

2. Adjust the distance associated with the *End of Row* warning. (Longer vehicles that take longer to turn need an earlier warning and so a greater distance).
3. Set the *Valve On Speed*:

- For vehicles that operate at normal speeds, select *Normal*.

Additional settings are supported only with NavController II firmware versions 5.10 and later.

- For vehicles operating at very slow speeds, select *Low* or *Ultra low*.

Speed thresholds that you can select from the display are:

- Normal > 0.4 m/s (1.3 ft/s)
- Low > 0.1 m/s (0.3 ft/s)

- Ultra low > 0.02 m/s (0.07 ft/s)
4. Tap **OK**.

## Configuring the implement controller

Your vehicle make and model were selected when your TrueTracker system was installed. If the details in the *Implement Controller Settings* group are correct, skip this step and go to [Configuring the implement, page 381](#). Otherwise, configure the implement controller as described here.

**Note** – When you configure the implement make and model, the previous calibration settings are lost. If you will want to use the current vehicle settings again, save them before you proceed.

## Configuring the implement make and model

**Note** – In version 3.0 of the FmX integrated display, the *Vehicle Profile Location* defaults to *From Database (new)*.

1. In the *Implement Controller Settings* group tap **Edit**:

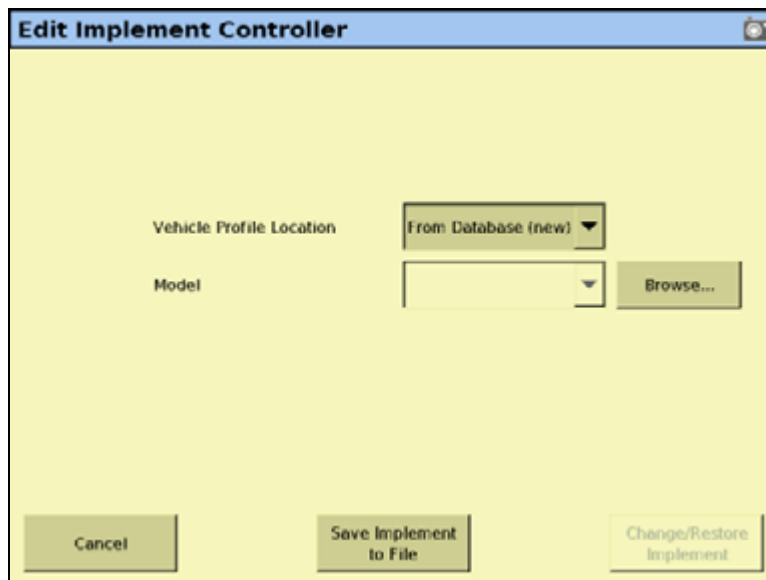

2. Do one of the following:
  - To select a new make and model from a database of vehicles (.vdb) on the FmX integrated display CompactFlash card:
    - a. In the *Vehicle Profile Location* list, select *From Database (new)*.
    - b. Tap **Browse**.
    - c. Select the required .vdb file and then tap **Open**.  
If you need to obtain a .vdb file, contact your local reseller.
  - To select an existing vehicle from a previously saved file (.cfg) on the card:

- a. In the *Vehicle Profile Location* list, select From Saved File (existing).
- b. Tap **Browse**.
- c. Select the required file and then tap **Open**.
3. Tap **Change/Restore Implement**. The following message appears:  
The specified implement model will now be selected on the Autopilot controller. This will cause the Autopilot controller to be reset. Do you want to continue?
4. Tap **OK** to load the new configuration or tap **Cancel** to abort. The **Autopilot Controller will now be reinitialized** message appears.
5. Tap **OK**. After the **Trained and qualified** warnings have appeared the file is loaded.

### Engage button

When implement steering is enabled, the Run screen **Engage** button changes state. It has two status indicators:

- The main button color, which represents vehicle steering.
- The small inner color, which represents implement steering.

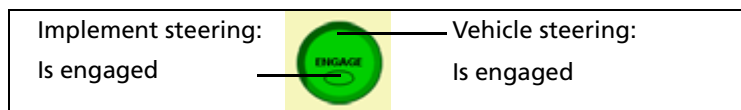



## Configuring the Engage button

You can set the **Engage** button to work in two different ways.

In the *Two stage engage* list, select the appropriate option:

The screenshot shows the 'Implement Setup' dialog box with the following settings:

Settings			
Nudge/Trim Increment	0' 0.0"	Smoothing Turn Radius	32' 9.7"
End of Row warning dist	164' 0.5"	Control coverage log	No
Operator alert time out	5 min	Two stage engage	Off

Below the settings is the 'Sensor Options' section with 'AutoSense' set to 'No'. At the bottom are 'Cancel' and 'OK' buttons.

Item	Description
On	The <b>Engage</b> button requires multiple taps to engage: <ul style="list-style-type: none"> <li>The first tap engages implement steering</li> <li>The second tap engages the vehicle steering</li> <li>The third tap disengages both implement and vehicle steering</li> </ul>
Off	The <b>Engage</b> button engages with one tap: <ul style="list-style-type: none"> <li>The first tap engages implement and vehicle steering</li> <li>The second tap disengages both implement and vehicle steering</li> </ul>

## Configuring the implement

Configure an implement so that the system can tell:

- which type of implement is attached
- how much area it covers
- how far it is offset

See [Chapter 7, Implement Configuration](#).

*Note* – When you enter the number of implement sections, if the implement does not have sections, enter **1**.

## Calibrating the implement

1. From the *Configuration* screen, select the TrueTracker plugin and then tap **Calibrate**:

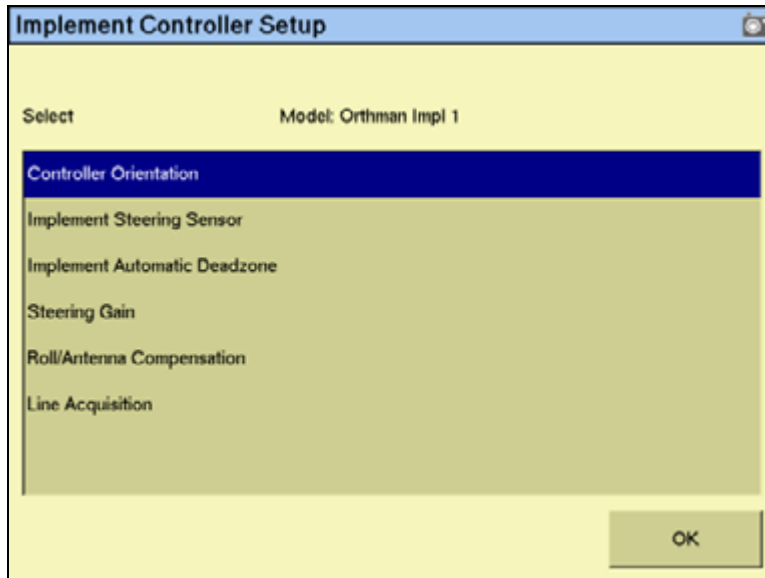

2. Select an item to configure and then tap **OK**.
3. Configure the selected item.

To configure...	See page...
Controller orientation	<a href="#">page 383</a>
Steering sensor	<a href="#">page 383</a>
Automated steering deadzone	<a href="#">page 384</a>
Steering gain	<a href="#">page 386</a>
Roll/antenna correction	<a href="#">page 391</a>
Line acquisition	<a href="#">page 393</a>

## Configuring the controller orientation

1. Select the *Controller Orientation* option from the list:

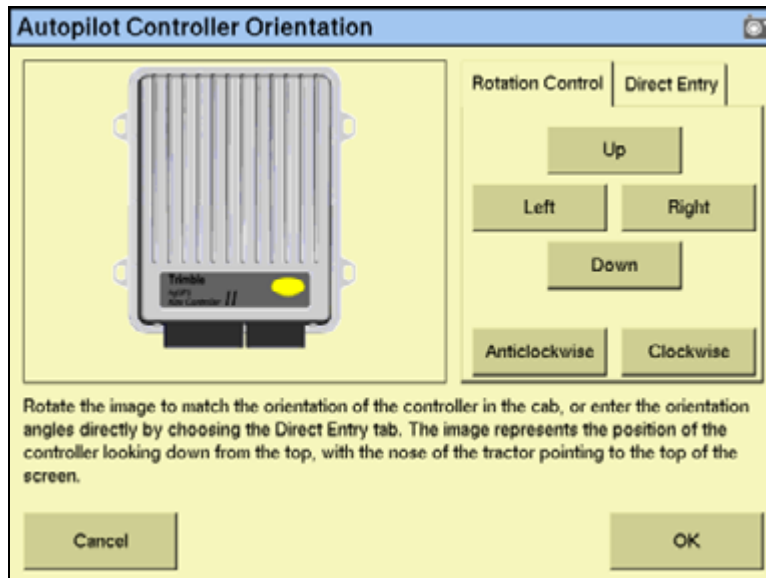

An image represents the current mounting orientation of the controller.

The image is shown as though:

- You are looking down on the vehicle from above.
- The top of the screen points to the front of the vehicle.

2. Use the buttons to select the orientation of the controller.

If the controller is set at a sloped angle, tap **Direct Entry** and then enter the yaw, pitch, and roll angles of the controller.

**Note** – If you use the *Direct Entry* method to set custom angles, the on-screen image of the controller does not appear.

3. Tap **OK** to accept the new orientation or tap **Cancel** to exit.

## Calibrating the Implement Steering Sensor

Perform steering sensor calibration to convert the voltage output of the steering sensor into an equivalent steering angle measurement.

**Note** – Complete this calibration **before** you attempt to calibrate the steering deadzone or roll correction procedures.

You must ensure that you:

- Perform this procedure on a level surface that is free of obstructions.
- Follow the instructions on each page.
- Run the engine at full throttle.

- Raise the implement.

To run the steering sensor calibration:

1. Select the *Steering Angle* procedure from the calibration list:

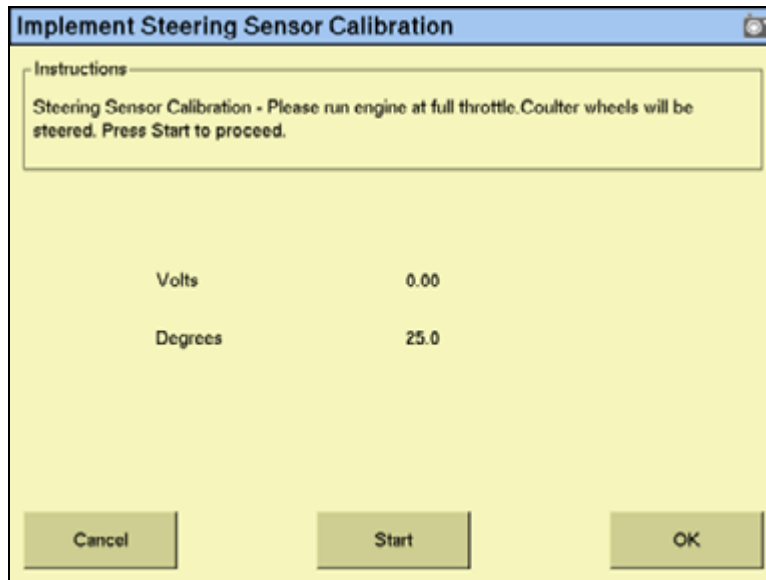

2. Tap **Start**.
3. Perform the calibration. The value in the *Volts* field is updated as the wheels are steered.

### Calibrating the Implement Automatic Deadzone

The Implement Automatic Deadzone calibration procedure runs a series of tests on the valve and steering hydraulics to determine the point at which steering movement occurs.



**WARNING** – During the Implement Automatic Deadzone calibration, the system moves the wheels that steer the implement. To avoid injury, make sure that the area around the vehicle and implement is clear.

In this test, the system independently opens and closes each side of the steering system while determining the point at which wheel movement occurs.

### Notes on calibrating the Implement Automatic Deadzone

- You must complete the Steering Angle procedure before you run this procedure. See [Calibrating the steering angle sensor, page 116](#).
- To ensure optimal system performance, the hydraulic fluid must be at normal operating temperature when you run this procedure. On some vehicles with large reservoirs, it may take several hours for the fluid to reach operating level, especially if the implement circuit is lightly loaded. Consult the vehicle documentation to determine if the hydraulic fluid temperature can be shown on a vehicle console.

- If you perform the calibration while the system is still cold, repeat both the Deadzone and the Proportional gain calibration procedures once the system is at operating temperature.

To configure the automated steering deadzone:

1. Place the vehicle in an area that is free of hazards.
2. Raise the implement.
3. Select the Implement Automatic Deadzone procedure from the calibration list. See [page 382](#).

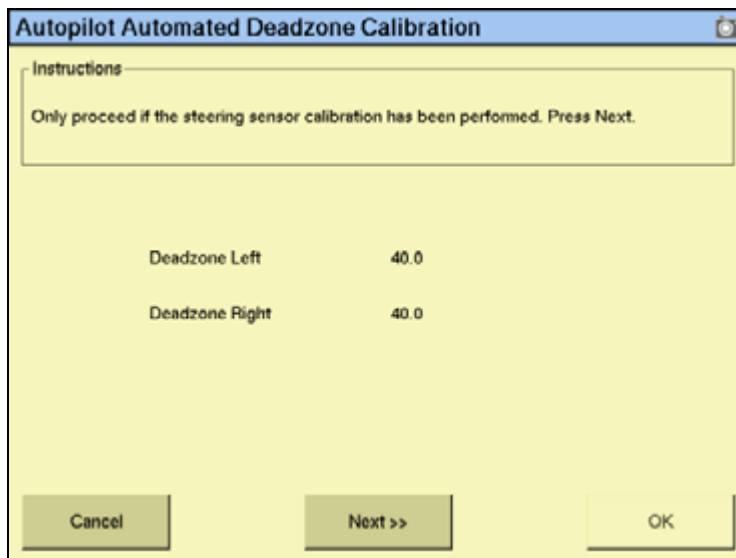

4. Tap **Next** to continue. The second *Autopilot Automated Deadzone Calibration* screen appears.
5. Tap **Next** in the two screens that appear next.

**Note** – Read the onscreen instructions on each page.

Follow the instructions. The system will automatically move the coultter wheels in both directions several times.

6. Tap **Start**. The system engages and performs the calibration.

### Automated Deadzone error messages

If a calibration cycle is unable to complete successfully, one of the following error messages appears:

Message	Meaning
Error - Steering Close To End Stops	Before the calibration cycle could be completed, the measured steering angle approached the end stops. Retry, and if the problem persists, instead of centering the steering at the start of each cycle, try turning the steering in the opposite direction to that which is being tested so that the calibration procedure has a greater range to test over.
Error - Valve Connectors Could Be Swapped	The calibration test sensed the steering turning in the opposite direction to what was expected. Retry, and if the problem persists either the valve connectors have been accidentally swapped or the steering sensor calibration was performed incorrectly.
Error - No GPS	A GPS receiver must be connected and outputting positions before the software can run the calibration procedure.
Error - No Steering Response Detected	During the calibration cycle, insufficient movement was sensed in order for the calibration to complete. If the problem persists, the hydraulic installation could be faulty.
Error - Unable To Determine DZ: Try Again	A problem occurred when trying to compute dead zone. Retry, and if the problem persists, contact Technical Support.

### Proportional steering gain calibration

*Note – Complete the steering sensor calibration **before** you perform the proportional gain calibration. Perform the proportional steering gain calibration **only** when the TrueTracker system performance is less than satisfactory.*

The proportional steering gain (PGain) setting enables you to reach a compromise between rapid steering response and stability. Modifications to the PGain setting affect two steering characteristics:

- *Slew Time:* The amount of time the steering coulters take to move from the far left to the far right position and vice versa.
- *Overshoot:* The percentage by which the steering coulters exceed the commanded angle before they settle on the correct value.

To correct slight variations caused by valve current response, friction, and hydraulic fluid viscosity, alter these settings.

High PGain values...	Low PGain values...
Decrease the slew time and increase the overshoot. This provides rapid responses, but can cause the steering to exhibit signs of instability (for example, a tendency to excessively overshoot).	Increase the slew time and decrease the overshoot. This improves the stability but can introduce significant delays in the steering response and can cause the vehicle to oscillate from side to side.

### **Notes on performing the proportional steering gain calibration**

- Perform the Automatic Deadzone calibration immediately before you run the PGain calibration, even if the Automatic Deadzone calibration has been performed in the past.
- Perform this calibration on a level surface, that is free of obstructions.
- Run the engine at full throttle.
- Raise the implement.

Increase the proportional gain up to the point just before any one of the following occurs:

- Slew times no longer decrease (a low value is required)
- Overshoot exceeds 10% (depending on the Tracker unit)
- Steering coulters noticeably shake near end stops

To calibrate the proportional steering gain:

1. Select the Steering Gain procedure from the calibration list:

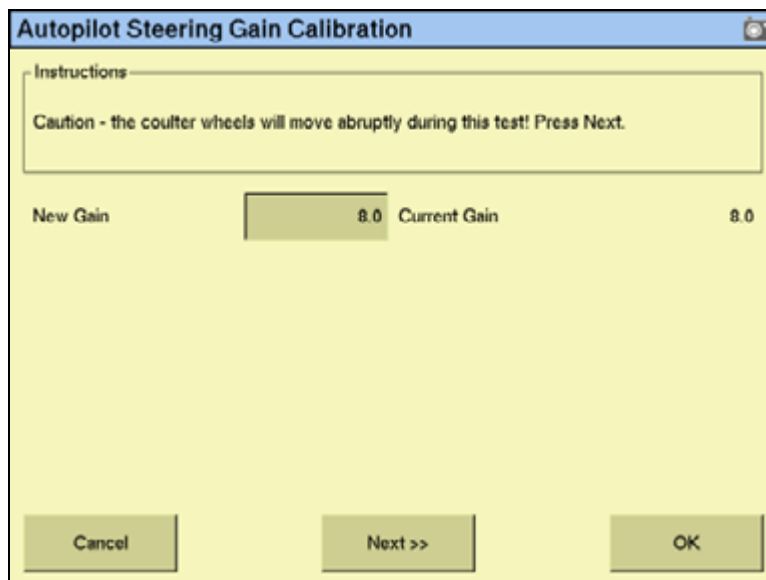

2. Tap **Run Slew Test**. A warning message appears.

3. Tap **Next**:

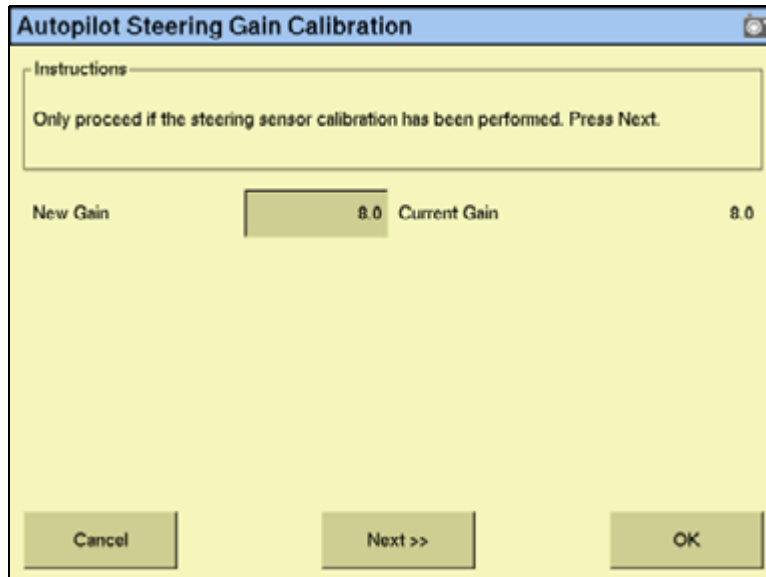

**CAUTION** – The steering coulters can move abruptly during the Proportional Steering Gain procedure while the TrueTracker system tests the hydraulic response to the steering commands. These sudden movements can cause collisions with nearby obstacles or cause injury. Be prepared for sudden steering coulters movements.

---

4. Tap **Next** in the two screens that appear next.
5. Test various gain settings while you monitor the implement steering performance and the values in the *Slew Time* and *Overshoot* fields for the Turn Left phase:
  - a. Adjust the *New Gain* field (if required).



- b. Tap **Turn Left**. Both turn buttons are unavailable while the wheels slew:

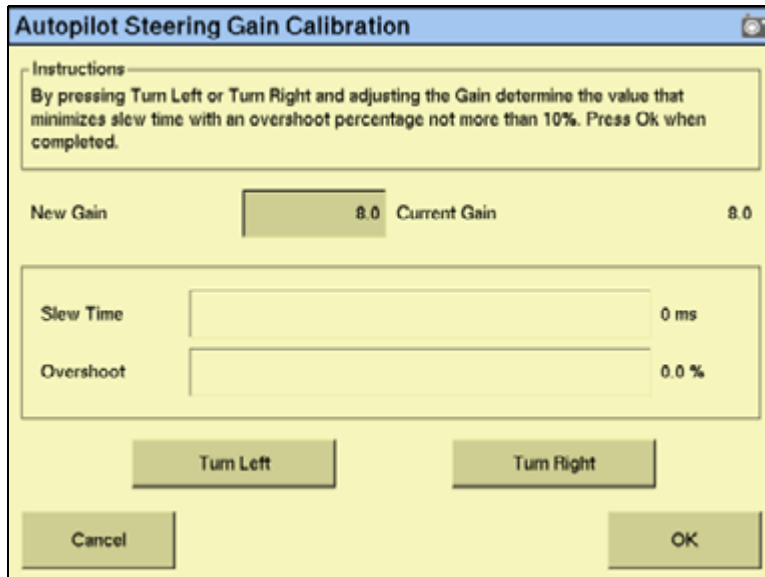

The screenshot shows a dialog box titled "Autopilot Steering Gain Calibration". It contains the following elements:

- Instructions:** "By pressing Turn Left or Turn Right and adjusting the Gain determine the value that minimizes slew time with an overshoot percentage not more than 10%. Press Ok when completed."
- New Gain:** A text input field containing the value "8.0".
- Current Gain:** A text input field containing the value "8.0".
- Slew Time:** A text input field containing the value "0 ms".
- Overshoot:** A text input field containing the value "0.0 %".
- Buttons:** "Turn Left", "Turn Right", "Cancel", and "OK".

*Note* – The optimum gain setting has short slew time (short millisecond reading) and overshoot percentage less than 10%.

6. Repeat Step 5 with **Turn Right**. Both turn buttons are unavailable while the wheels slew.
7. When you locate the best gain value, do one of the following:
  - Tap **OK** to save the value in the Autopilot controller memory.
  - Tap **Cancel** to restart the calibration procedure.

## Configuring the antenna position and roll offset correction

1. Select *Roll/Antenna Compensation* from the calibration list:

2. Before changing these settings, complete the procedures described below.

### Notes on configuring the antenna position

- Before configuring the antenna compensation, make sure that:
  - the TrueTracker system is completely set up
  - the Autopilot software is properly configured
  - the correct GPS corrections are enabled

Read this section carefully before you attempt the configuration.

### Setting the antenna height above the ground

1. Place the tractor and implement on a flat, level surface.
2. Measure the distance from the ground to the base of the GPS receiver (or antenna).
3. Enter this value in the *Antenna Height Above Ground* field.

### Setting the antenna distance from the center-line

1. Place the tractor and implement on a flat, level surface.
2. Measure the distance from the centerline of the implement to the center of the GPS receiver (or antenna).
3. Enter this value into the *Antenna Distance from centerline* field and indicate whether it is left or right of the centerline. Values to the left of the centerline are displayed as negative numbers. The nose of the vehicle is considered the forward direction.

## Configuring the roll offset correction

Use one of the following methods to calculate the roll offset and then enter the roll offset correction to compensate for it:

- Coulter wheel track offset method
- Flag offset method

Choose the method that best matches the conditions.

### Calculating the roll offset: Coulter wheel track offset method

1. Drive the tractor to a relatively flat field where tire impressions are visible and where you can complete passes of at least 400 m (1320 ft) in length.
2. Reset the roll offset value to 0 (zero).
3. Start a new field.
4. Create a straight AB Line.
5. Create a clean set of tire tracks in the field. To do this, start a new pass away from the area where the AB Line was created. When the system is stable, engage automatic steering mode and allow the Autopilot and TrueTracker systems to complete the pass.
6. At the end of the pass, turn the tractor around to return along the same pass from the opposite direction.
7. Engage automated steering mode and allow the system to complete the pass.
8. In the middle of the return pass, stop the tractor and confirm that the current position is directly on the AB Line. This ensures there is no cross track error.
9. Park the tractor and exit the cab. Evaluate the coulter wheel track pattern between the first and return paths.
10. Measure the difference between the track passes and record the distance. Also note whether the return pass is to the left or the right of the original pass. Record the results in [Table 12 on page 393](#).

**Note** – The offset should be consistently to the left or right.

11. Repeat Step 5 through Step 10 two more times, for a total of three test runs. Use [Table 12 on page 393](#) to record the offset distance and the left or right direction of offset for each test run.

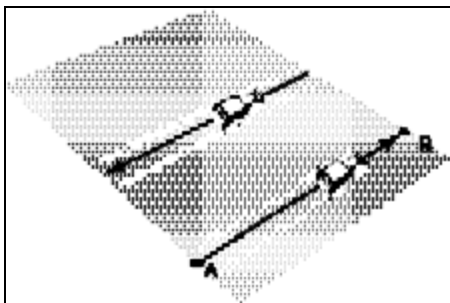

### Calculating the roll offset: flag offset method

1. Drive the vehicle to a relatively flat area where you can complete passes that are at least 400 m (1320 ft) in length.
2. Reset the *Roll Offset* value to 0 (zero) on the *Roll Correction* screen. See [Configuring the roll offset correction, page 391](#).
3. Start a new field.
4. Create a straight AB Line.
5. Start a new pass. Engage automatic steering mode when the system is stable. Stop the tractor midway through the pass. Confirm that there is no cross track error: the current vehicle position should be directly on the AB Line.
6. Park the vehicle and exit the cab. Insert a flag in the ground to mark the implement centerline for this pass.
7. Complete the pass. Turn the vehicle around to return along the same pass from the opposite direction.
8. Engage automatic steering mode. Stop the vehicle midway down the pass very close to the marker flag. Confirm that there is no cross track error: the current vehicle position should be directly on the AB Line.
9. Park the vehicle and exit the cab. Insert a second flag in the ground to mark the implement centerline for this pass. Note whether the second pass is to the left or the right of the first pass.
10. Measure the difference between the flags for the two passes and record the distance. Also record whether the return pass is to the left or the right of the original pass. Record the results in [Table 12 on page 393](#).

**Note** – *The offset should be consistently to the left or right.*

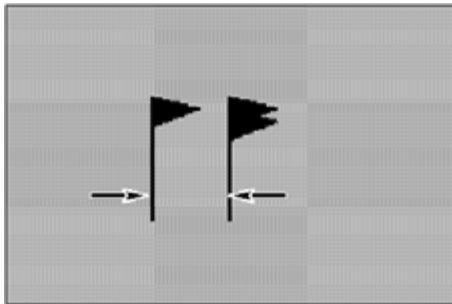

11. Repeat Step 5 through Step 10 two more times for a total of three test runs. Use the table shown below step 12 to record the offset distance and the left or right direction of offset for each test run.

- Average the results of the three runs. (Total the offset distances from the three passes and divide by three). Use the following table to record the roll correction results:

Test run	Offset distance	Offset direction
1		
2		
3		
	Total =	
	Total/3 = (Average offset value)	

### Entering the roll offset

- Enter the average offset value in the *Roll Offset* field. See [Configuring the antenna position and roll offset correction, page 390](#).
- Select one of the offline direction options, depending on whether the roll offset distance is to the left or right.

### Calibrating the line acquisition aggressiveness

- Select *Line Acquisition* from the calibration list:

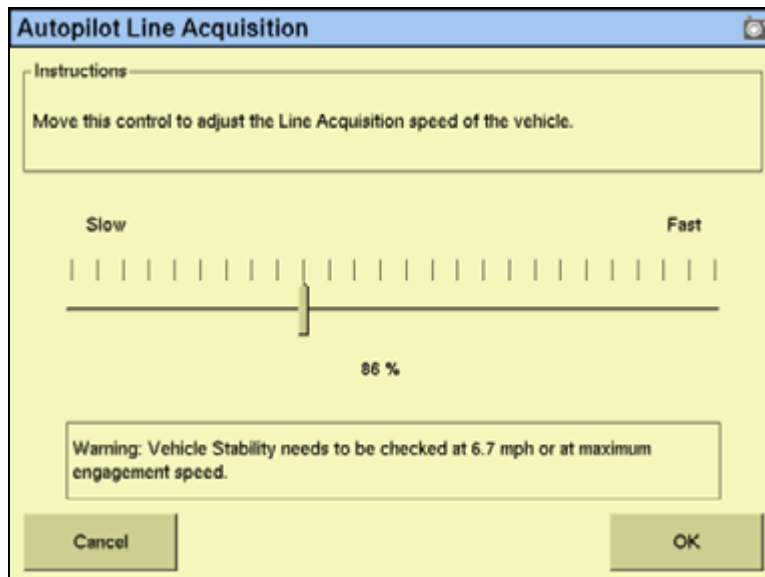

Adjust the line acquisition aggressiveness slider. The slider controls how aggressively the implement approaches the guidance line, using a scale from 50% to 150%. The optimal value for each profile is not necessarily 100%: it varies for different implement profiles.

## Using the TrueTracker system

When you have configured the TrueTracker plugin, you can begin driving in the field with implement steering.

### Main guidance screen

The FmX integrated display's main guidance screen changes when implement steering is enabled.



Item	Description	See page...
1	Implement lightbar	394
2	Implement GPS information button	395
3	Implement status text items (hidden)	395
4	Implement tab	396
5	Implement steering engage button	381

### Implement lightbar

When implement steering is enabled, a second, smaller lightbar appears below the main lightbar:

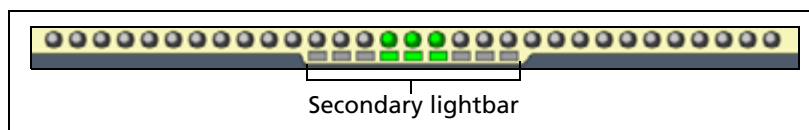

This lightbar shows the implement guidance relative to the guidance line. Each LED on the second lightbar represents 1 inch.

### Implement GPS information button

Tap the *implement GPS information* button  to view extra implement receiver status information. Tap **OK** to return to the Run screen.

### Implement status text items

A number of status text items provide information about the implement. For more information, see [Status items, page 77](#).

You can set these status text items to appear permanently at the top of the screen or on a slide-out tab. To view the following items, tap the corrections status button at the top right of the screen:

- Implement GPS Status
- Implement Correction Type
- Implement Correction Age
- Latitude
- Longitude
- Altitude
- Satellites
- HDOP
- VDOP
- Network ID

## Implement tab

When the TrueTracker plugin is installed, the TrueTracker tab becomes available on the main Run screen:

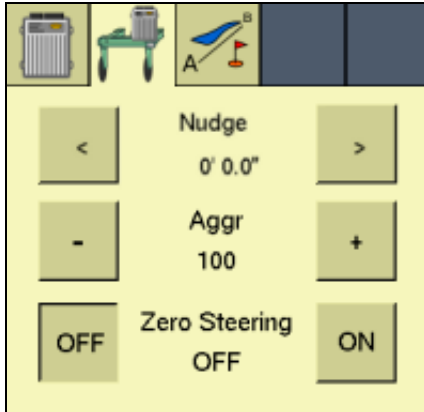

The TrueTracker tab enables you to adjust the implement steering independently of the vehicle steering. For example, if you can see that the implement is consistently to one side of the guidance line but the vehicle is correctly online, you can apply Trim to the implement to correct it.

When turned on, Zero Steering commands the steering to zero degrees left/right, centering the steering device on the implement. This option can be turned on in the field, keeping the coulters pointed straight, or just at the ends of the field to center the steering.

*Note – Disengaging the TrueTracker system automatically turns off Zero Steering.*

*Note – If the implement is consistently offline, there may be a roll calibration issue. Recheck the roll calibration.*

## Configuring the Engage button

You can configure the **Engage** button to work in two different ways:

Item	Description
Single press	The <b>Engage</b> button engages with one tap: <ul style="list-style-type: none"> <li>The first tap engages implement and vehicle steering</li> <li>The second tap disengages automated steering</li> </ul>
Two-stage press	The <b>Engage</b> button requires two taps to engage: <ul style="list-style-type: none"> <li>The first tap engages implement steering</li> <li>The second tap engages the vehicle steering</li> <li>The third tap disengages automated steering</li> </ul>

To configure how the **Engage** button works, see [Configuring the implement controller](#), page 379.



## The Serial Rate Control Plugin

### In this chapter:

- Non-Trimble variable rate controllers
- Additional information for non-Trimble variable rate controllers

The FmX integrated display can be connected to third-party variable rate controllers by a range of manufacturers.

This chapter describes how to configure the display for use with these rate controllers.

*Note* – You can install only one variable rate control plug at a time.

## Non-Trimble variable rate controllers

The FmX integrated display supports the following non-Trimble variable rate controllers:

Make	Model	See page...
Raven	SCS 440, 440DB, 450, 450DB, 460, 660, 661, 700, 710, 750, 760	<a href="#">page 401</a>
Rawson	Accu-Plant and Accu-Rate	<a href="#">page 402</a>
New Leader	Mark III and Mark IV	<a href="#">page 402</a>
Hardi	5500, 6500	<a href="#">page 404</a>
Tyler	Flex-Air	<a href="#">page 404</a>
Bogballe	Calibrator Zurf	<a href="#">page 405</a>
Vaderstad	Control Station	<a href="#">page 405</a>
Amazone	Amatron+	<a href="#">page 405</a>
LH Agro	LH5000	<a href="#">page 406</a>

The FmX integrated display can send control signals to vary only one channel at a time.

*Note* – Before you can make any changes, you must close all fields.

To use a non-Trimble variable rate controller to operate a spray boom, do the following:

1. Install the non-Trimble variable rate controller. See [page 398](#).
2. Enable the Serial Rate Control plugin. See [page 399](#).
3. Select the port for the variable rate controller. See [page 399](#).
4. Configure the spray boom in the FmX integrated display. See [page 399](#).
5. Enable and configure the variable rate controller in the FmX integrated display. See [page 399](#).
6. Configure the variable rate controller. See [page 401](#).
7. Set any other features of the variable rate controller. See [page 406](#).

### Installing a non-Trimble variable rate controller

Use the hardware provided with your variable rate controller to mount it in the vehicle cab.

To use a variable rate controller, you must connect it to port A or B of the FmX integrated display using the connection cable (P/N 67091) and the associated cable for the supported controller. Your controller may need a special adaptor cable to work correctly. If so, contact your local Trimble reseller.

Most controllers also need to be configured to accept input data from the FmX integrated display. For additional instructions, see the following section for your controller.

*Note* – Always make sure that the serial port connector is in place with screws firmly tightened (if available).

## Enabling the Serial Rate Control plugin

For instructions on installing the Serial Rate Control plugin, see [Entering the password to activate a plugin, page 193](#).

## Configuring the spray boom in the FmX integrated display

Configure the spray boom as described in [Chapter 7, Implement Configuration](#).

## Enabling and configuring the variable rate controller (in the FmX integrated display)

1. From the *Configuration* screen, select the Serial Rate Control plugin and then tap **Setup**:

**Note** – The fields that appear on the screen depend on which controller you selected.

2. Select the controller make from the *Controller* drop-down list.
3. Select the display port the controller is connected to from the *Port* drop-down list.
4. If the *Active Channel* field appears, enter the active channel name.
5. In the *Send Rate As* list, select the unit of measure.
6. In the *Rates* tab, enter the default rate and step size for the controller in the *Default Rate* and *Step Size* text fields

7. In the *Rate Snapping* list, select Enabled or Disabled:

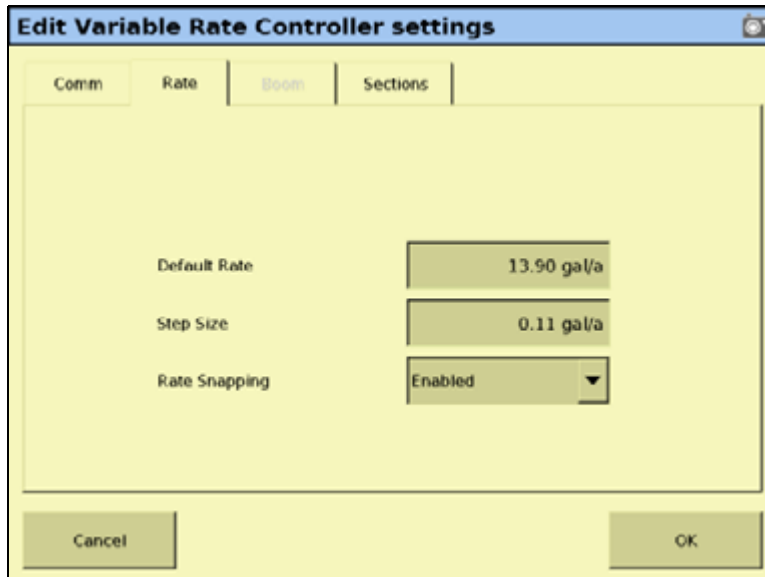

8. Tap **OK**:

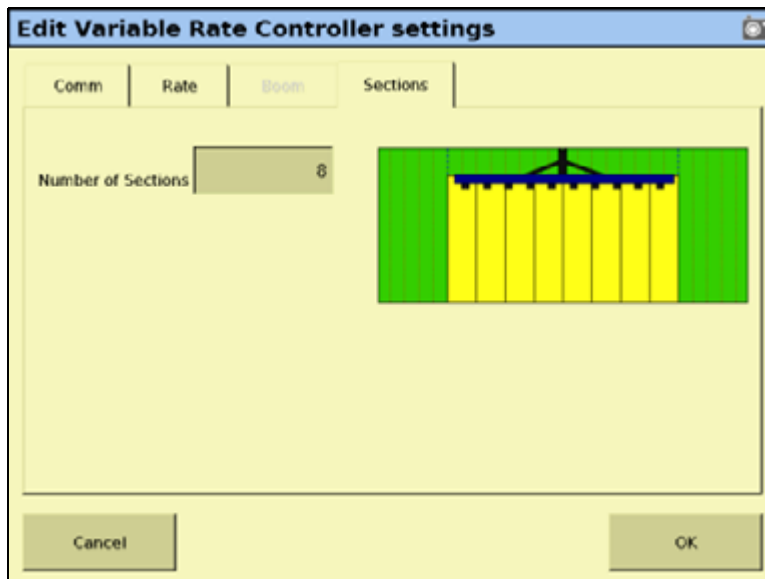

9. In the *Rates* tab, enter the number of sections in the *Number of Sections* field.

## Configuring the variable rate controller

If you specified a variable rate controller type, the FmX integrated display initiates communications with the controller each time that you open a field. Communications are terminated when you close the field.

If the FmX integrated display cannot communicate with the controller:

- A message appears identifying the problem. If the specified controller type has a configurable baud rate, the error message includes details of the baud rate that the FmX integrated display requires the controller to use.
- The *Applied rate* disappears from the Run screen.
- Variable rate logging is suspended while the controller is disconnected.

## Raven

To use a Raven controller with an FmX integrated display, the controller must:

- be GPS-ready
- use Raven's latest communications protocol, which was introduced in 1996.

If your controller is not GPS-ready or does not use the latest protocol, contact Raven for an upgrade pack.

To use a Raven controller, you need a special adaptor cable (Trimble P/N 69729) to connect to the FmX cable (P/N 67091), which is connected to port A or B on the display.

## Configuring the controller

For a Raven controller to operate correctly with an FmX integrated display, the following *Data Menu* settings are required:

- BAUD: 9600
- GPS: Inac
- DLOG: ON
- TRIG: 1
- UNIT: Sec

Some Raven controllers may “forget” settings if power is disconnected. You must then reconfigure the controller.

## Application width

When the FmX integrated display is connected to a Raven controller, the total boom section width must be set to match the *Application Width* setting in the *Implement Boom Setup* screen.



**CAUTION** – The first boom section width set on the Raven controller **must** be greater than 0. If you set it to 0, the display will not communicate with the controller.

The FmX integrated display varies the width of the coverage polygons according to the number of boom sections, but it does not know the **absolute** width of each boom section—it only knows the **relative** width of each boom section with respect to the total boom section width.

When recording coverage polygons, each section is considered to be a percentage of the *Application Width* set in the FmX integrated display *Implement Boom Setup* screen. For example, if you create an intentional overlap to avoid gaps in the application coverage by making the application width greater than the swath width. This proportionally changes the recorded width of each boom section.

### Using the controller

To allow the rates being sent by the FmX integrated display to be used by the Raven controller, the channel must be set to Rate 1 (SCS4XX, SCS6XX) or to Product X Auto (SCS7XX).

If the controller is set to Rate 2 or Manual, the controller ignores the rates being sent, but the display still records the applied rates.

### Limitations

Set the baud rate to 9600. Some older controllers are only capable of 1200 baud—these controllers need to be upgraded.



**CAUTION** – Some Raven controllers do not support zero rates. If the target rate is zero, and spray is still being applied, you must turn off the boom sections manually.

---

### Rawson and New Leader

The Rawson and New Leader controllers use a nominal flow rate (Yield) and a step size to describe rates.

Set the *Default rate* in the *Edit Variable Rate Controller settings* screen to match the *Yield* value (or nominal flow rate) in the Rawson controller.

Any non-zero rate will be adjusted to the nearest value that the controller can select. A rate of zero turns off the hydraulic drive.

**Note** – For best result when creating prescriptions, use rates in 2%, 4%, or  $6\frac{2}{3}\%$  increments of the default rate. Select the percentage used on FmX integrated display.

If you have a dual-channel Rawson Accu-Rate controller, see [page 403](#).

### Configuring the controller

To allow the display to change the rates on the controller, the controller must first be put into GPS mode. Otherwise, the display will log only the rates being used:

1. Turn on the controller.
2. Tap the **MODE** button twice.

3. Tap the **SET** button to switch the controller between GPS and non-GPS.

### Communications

Connect the FmX integrated display to the controller with Rawson cable (P/N 69730) and Trimble cable (P/N 67091) and set the controller baud rate to 9600.

### Using the controller

When in GPS mode, the hydraulic drive operates only when both the switch and the display allow the drive to be on. Set the hydraulic drive switch on the controller to the ON position. If you need to quickly turn off the hydraulic drive, use the switch on the controller.

### Non-GPS mode

The FmX integrated display sends commands to the controller. If communication cannot be established, it may be because the controller is set to Non GPS mode. A message appears and gives you the option to continue in Non GPS mode.

If the controller is set to Non GPS mode, the display still shows and records as-applied rates. If a prescription is loaded, target rates appear for reference, but these are not used by the controller. In this mode, you must vary rates manually on the controller.

### Loss of communication

In GPS mode, if communication with a Rawson controller is lost, the display does not report an error until you cross into a region of the prescription that specifies a different rate.

In Non GPS mode, the display has no way of knowing when communication with a Rawson controller is lost.

### Special note on using a Rawson Accu-Rate controller

The display can send rates and record coverage for the Rawson Accu-Rate controller for only one drive at a time: either Drive A or Drive B.

To correctly send rates to the controller and log coverage based on the drive master switch, do the following:

- To operate both drives, set the drive that is *not* being controlled by the display to *Non GPS mode* (see above).
- Connect the FmX integrated display Variable Rate cable to the COM port that matches the drive:
  - To control Drive A, connect to COM A.
  - To control Drive B, connect to COM B.
- When you use Drive B, set the COM port to COM B. Drive A does not have a configuration for this and will always use COM A.
- Set Bit 7 mode to off. Bit 7 mode sends two prescriptions and is not supported by the FmX integrated display.

## Hardi 5500 and 6500

To use the Hardi 5500 or 6500, you need a special adapter cable (Trimble P/N DCA6219) to connect to the FmX cable (P/N 67091) that is connected to Port A or B on the display. Optionally, you can use an extension (straight through) serial cable.

### **Notes:**

*Connect the cable to serial port 1 on the Hardi controller.*

*On the Hardi 6500, you must use the terminal version 1.55 or later and Jobcom version 1.55 or later.*

*The Hardi 6500 must be set to metric units.*

## Configuring the controller

To set up the controller to operate correctly with the FmX display, do the following:

1. Turn on the controller.
2. Hold the **ESC** button while turning on the Hardi controller.
3. In the extended menu, use the arrow keys to select the *E.4 Data Exchange* menu.
4. Enter the COM 1 setup and set the following:
  - Equipment type: VRA/remote
  - Protocol: Hardi VRA
  - Baud Rate: 9600
5. Turn off the controller and then turn it on.
6. Go to *Menu 2.3* and select *VRA/Remote Control Enable*.

## Flex-Air

The FmX integrated display can send rates to the Tyler Flex-Air variable rate controller. The controller can have four channels: main, liquid, co-applicator, and supplemental. Rates from all channels are recorded in the variable rate logging .dbf file, but the FmX integrated display can send rates to only one channel at a time—the active channel.

The Tyler Flex-Air controller uses the GPS speed sent by the FmX integrated display.

## Using the Tyler Flex-Air controller

The *Total\_Qty* field in the variable rate logging .dbf file, and the *Avg\_Rate* field in the EventHistory .dbf file, record statistics for the active channel. If you want to use these statistics, start a new event *before* you change the active channel.

## Application width

You can individually configure the widths of the boom sections on the controller. The FmX integrated display draws coverage logging at the width of the sum of all the boom sections. If you turn boom sections off, the FmX integrated display varies the width of the coverage polygons according to which boom sections are on.



## Bogballe Calibrator

To use the Bogballe Calibrator, you need a special adapter cable (Trimble P/N DCA6219) to connect to the FmX cable (P/N 67091) that is connected to Port A or B on the display. Optionally, you can use an extension (straight through) serial cable.

*Note* – The standoff nuts on the Bogballe rate controller may prevent the pins in the cable connector from making a connection. In this case, remove the standoff nuts.

### Configuring the controller

To set up the controller to operate correctly with the FmX display, do the following:

1. Press **Return / Return / Fertil.-Distrib / Select Type / Bogballe E/EX / Accept**.

## Vaderstad Control Station

To use the Vaderstad Control Station, you need a special adapter cable (Trimble P/N DCA6219) with a crossover serial cable (null modem) that connects to the Vaderstad program cable (Vaderstad P/N 428017). Plug the Vaderstad cable into the GPS port on the back of the Control Station controller.

### Configuring the controller

To set up the controller to operate correctly with the FmX display, do the following:

1. Press the **?** button and hold it down while turning on the controller.
2. In the *Setup* screen, scroll to *GPS* and then select *No*.

*Note* – Pressing **?** and selecting *Info* will not work if the unit is communicating with the FmX integrated display.

## Amazone Amatron +

To use the Amazone Amatron +, you need a special adapter cable (Trimble P/N DCA6219) to connect to the FmX cable (P/N 67091) that is connected to Port A or B on the display. Optionally, you can use an extension (straight through) serial cable.

*Note* – Connect the cable to the pinned connector on the lower left side of the Amatron + controller.

### Configuring the controller

To set up the controller to operate correctly with the FmX display, do the following:

1. Press **Shift + Page / Setup / Page 2**.
2. Set RS232 to 57600 baud.

## LH5000

To use the LH 5000 controller, you need a special adapter cable (LH Agro P/N 198-701) to connect to the FmX cable (P/N 67091) that is connected to Port A or B on the display. Optionally, you can use an extension (straight through) serial cable.

### Configuring the controller

To set up the controller to operate correctly with the FmX display, do the following:

1. Press **Return / Return / Fertil.-Distrib / Select Type / LH500 / Accept**.

## Setting any other features of the variable rate controller

### Coverage mapping

The FmX integrated display receives the applied rate and can also receive the number of active boom sections from a variable rate controller. It does not receive any information about the swath or application width.

To accurately record coverage maps, if your controller does not send the number of active boom sections, make sure that you set the application width to match the agricultural equipment that you are using (for example, the width of the spray boom).

### Target and applied rates

The FmX integrated display can control only a single channel at any one time. This active channel is specified in the *Edit Variable Rate Controller settings* screen. The target and applied rates shown on the Run screen are specific to this active channel.

### Units

Most controllers can be configured to use either US Imperial or metric units of measurement. Each channel can be configured to use different types of units (for example, lb/ac, oz/ac, or gal/ac.).

When constructing prescription maps, make sure that the maps use the same units that the controller is configured for.

### Alarms

If you want low limit and target rate alarms, set these on the variable rate controller. You can also set a default rate to be used if you go off the prescription or do not have a prescription. For more information, refer to the documentation provided with your variable rate controller.

## Additional information for non-Trimble variable rate controllers

### Prescriptions

You can define variable rate controller setup data, and load prescription files that define the rates to be applied in different areas of the field. This information is used to send target rates to the variable rate controller. Applied rates are received from the controller, and both target and applied rates are shown on the screen. In addition, data relating to the variable rate application may be logged to the card.

The information describing prescriptions for the Field-IQ system also applies to non-Trimble variable rate controllers.



## The Remote Output Plugin

### In this chapter:

- [Connecting remote output](#)
- [Configuring the Remote Output plugin](#)
- [Calibrating the lead time for your implement](#)

When remote output is activated, the FmX integrated display outputs pulses for an external device. For example, you can use a remote output signal to control a tree planter.

This chapter explains how to configure the Remote Output plugin so that the display can output data.

## Connecting remote output

The signal that is output on pin 2 of the FmX integrated display's B port is a 5 volt signal with a rating of approximately 70 mA; this signal controls the device that requires the remote output. The relay is grounded to pin 10 of the display's B port.

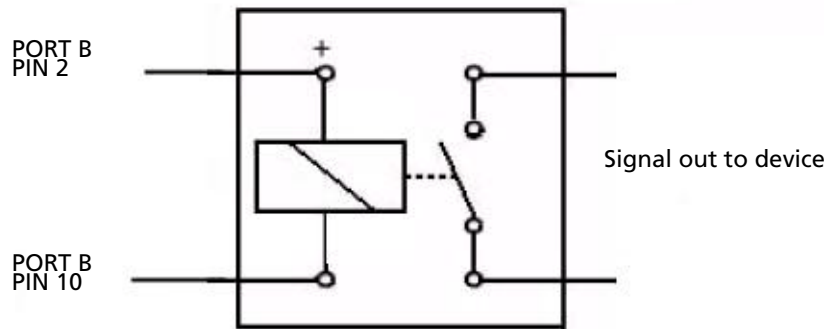

## Configuring the Remote Output plugin

When remote output is activated, the FmX integrated display sends pulses to an external device. For example, you can use a remote output signal to control a tree planter.

*Note – Pulse output occurs only when coverage logging is enabled.*

To enable pulse remote output:

1. Install the Remote Output plugin. See [Adding or removing a plugin, page 192](#).
2. From the *Configuration* screen, select the Remote Output plugin and then tap **Setup**.

The *Remote Output* screen appears:

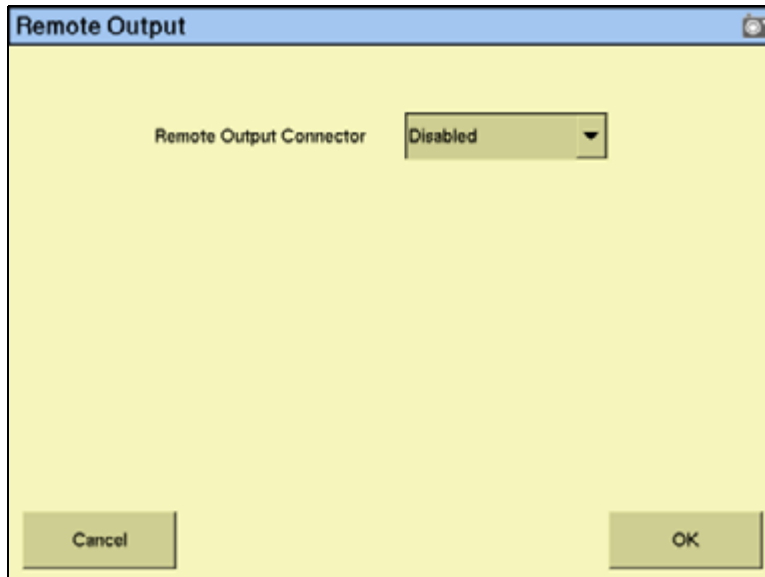

3. From the *Remote Output Connector* drop-down list select *Connector B*. The default option is *Disabled*. More options appear:

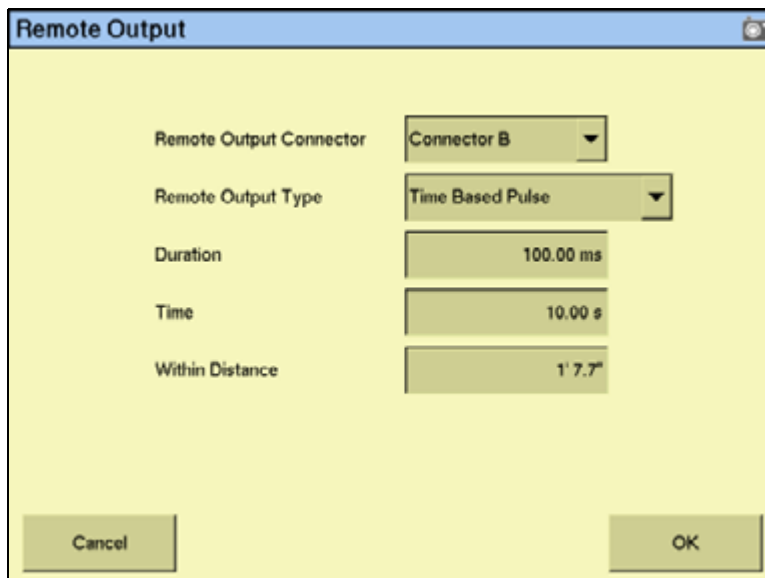

4. From the *Remote Output Type* drop-down list, select one of the following:

If you select...	Then enter...
Time Based Pulse	<ul style="list-style-type: none"> <li>the pulse interval in seconds in the <i>Time</i> field.</li> <li>the pulse duration in milliseconds in the <i>Duration</i> field.</li> </ul>
Distance Based Pulse	<ul style="list-style-type: none"> <li>the <i>Lead Time</i>. See <a href="#">Calibrating the lead time for your implement, page 412</a>.</li> <li>the Distance in meters/decimal feet/feet and inches in the <i>Distance</i> field. The pulse occurs at each increment of this distance.</li> </ul> <p><b>Note</b> – The first pulse occurs at the A point. Pulse remote output is not recommended for Headland patterns.</p> <ul style="list-style-type: none"> <li>the duration of the pulse in milliseconds (ms) in the <i>Duration</i> field.</li> <li>the distance in the <i>Within Distance</i> field. The pulse occurs only when the vehicle is within this distance of being online. If the vehicle is more than this distance offline, no pulse occurs.</li> </ul>
When Within Area Feature	<p>the <i>Lead Time</i>. See <a href="#">Calibrating the lead time for your implement, page 412</a>.</p> <p><b>Note</b> – The pulse occurs only when Remote Output is enabled. You must also enable Remote Output for each area feature individually in the Mapping plugin setup. See <a href="#">Creating an area feature, page 92</a>.</p>
When Engaged	nothing: There are no options to set. Remote output occurs when the system is engaged.

5. Tap **OK**.

Remote output is now configured. If you are using Distance Based Pulse or When Within Area Feature, calibrate the *Lead Time* setting to match your implement.

## Calibrating the lead time for your implement

There is usually a gap between the time when the system generates a pulse and the time when that pulse triggers an action on the implement. To compensate for this system delay, you can set a **lead time** to trigger the pulse slightly early, so that the action occurs at the correct location.

For this calibration, you drive the vehicle along a line and back, using the Remote Output plugin to mark points on the ground. If the remote output is correctly calibrated, the points that you generate when driving in both directions will be close together.

This section describes some implement calibration steps. See also, [Chapter 7, Implement Configuration](#).

Do the following:

1. Set the front/back offset. See [page 413](#).
2. Calibrate the front/back offset. See [page 413](#).
3. Set the lead time. See [page 413](#).



## Setting the front/back offset



**CAUTION** – You must configure the correct front/back offset. If you are using an Autopilot system, set the front/back offset to the distance from the **fixed axle of the vehicle** to the implement. If you are using manual guidance, set the front/back offset to the distance from the **antenna center-point** to the implement.

1. Accurately measure whichever of the following options is appropriate:
  - Autopilot systems: The distance between the fixed axle of the vehicle and the part of the implement where the trigger marks will be applied on the ground.
  - Manual guidance systems: The distance between the antenna center-point and the part of the implement where the trigger marks will be applied on the ground.
2. From the *Configuration* screen, tap **Implement Setup** and then enter this value as the *F/B Offset* distance on the *Implement Boom Setup* screen.

## Calibrating the front/back offset

1. Create a straight AB Line.
2. In the Remote Output plugin, set the *Lead Time* to 0.
3. Drive **as slowly as possible** down the AB Line from point A to point B, marking points on the ground where the remote output triggers.
4. At the end of the line, turn the vehicle around.
5. Drive back down the line from point B to point A, marking another set of trigger points.
6. Measure the distance between the points from the first run and the points from the second run.
7. Divide the distance by two.
8. Adjust your *Front/Back Offset* value by this amount:
  - If the return points are nearer where you originally started than the first set of points, increase the F/B offset.
  - If the return points are further from where you originally started than the first set of points, lower the F/B offset.

## Setting the lead time

1. Drive **at your intended application speed** down the AB Line from point A to point B, marking points on the ground where the remote output triggers. Ensure that your speed remains constant.
2. At the end of the line, turn the vehicle around.
3. Drive back down the line from point B to point A, marking the trigger points.

4. Measure any offset distance between the points from the first run and the points from the second run.
5. Divide the distance by two.
6. Convert your speed from mph to inches/second:

$$\text{inches/second} = \text{mph} \times 17.6$$

7. To calculate the *Lead Time* setting, divide the distance between the points (in inches) from Step 5 by the vehicle speed (in inches/second):

$$\frac{\text{Half the distance between points (inches)}}{\text{Speed (inches / second)}} = \text{Lead Time (seconds)}$$

8. Enter the lead time on the *Remote Output* screen:

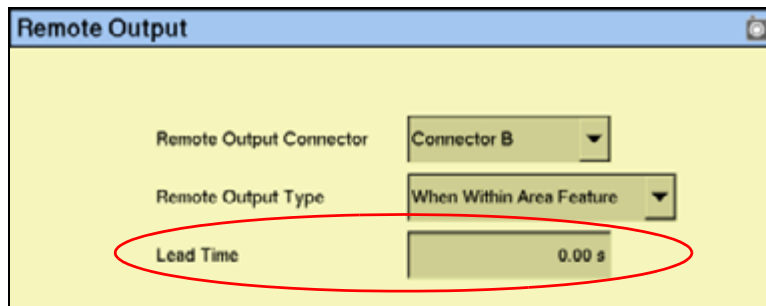

For example, if a 4 mph pass creates a 14" distance between each set of points:

- a. Divide the distance between the points by 2.  
In this example,  $14" / 2 = 7"$ .
- b. Convert the speed from mph to inches/second.  
 $4 \text{ mph} = (4 \times 17.6) = 70.4 \text{ inches/second}$ .
- c. Divide the halved distance between the points by the speed:

$$\frac{7 \text{ inches}}{70.4 \text{ inches/second}} = 0.099 \text{ (Lead Time in seconds)}$$

- d. Drive along the AB line and then back at your application speed while you create trigger points.
  - e. Ensure that the trigger points are sufficiently close to one another.
- If the gap between the points is unacceptable, repeat the calibrations.

## The Serial Data Input Plugin

### In this chapter:

- [Connecting serial data input](#)
- [Configuring serial data input](#)

When serial data input is activated, the FmX integrated display can receive and log NMEA messages from an external device (for example, an infra-red sensor).

This chapter explains how to configure the display to receive data.

## Connecting serial data input

To connect a device to the FmX integrated display, connect the Variable Rate Control cable (P/N 67091) to the port D connector on the display.

The other end of the Variable Rate Control cable connects to a serial connector.

*Note* – An additional adaptor may be required depending on the pin-out for the serial device.

## Configuring serial data input

1. Install the Serial Data Input plugin. See [Adding or removing a plugin](#), page 192.
2. On the *Configuration* screen, select the Serial Data Input plugin and then tap **Setup**:

Setting	Value
Port	Connector B
Baud rate	9600
Parity	None
Data bits	8
Stop bits	1
Prefix	
Suffix	I0D\0A
Log Interval	60.00 s

3. In the *Port* list, select the port that the device is connected to. It is usually P5 Serial I/O. Configuration settings for that port appear on the right of the screen.
4. Set the following to the values at which the sensor outputs data:
  - Baud rate
  - Parity
  - Data bits
  - Stop bits
5. The *Prefix* and *Suffix* fields are the start and end points of the data you want to collect.
  - To log data from the start of the line, leave the *Prefix* field empty.
  - To drop introductory characters, enter them in the *Prefix* field. For example, if you receive data that begins “\$GP GGA...”, enter “\24GP” in the *Prefix* field. The logged data will begin “GGA...”

**Note** – “\24” is the ASCII code for “\$”.

- To log to the end of the line, keep the default *Suffix* field (“\0D\0A”).
6. Enter the log interval. This determines how regularly the data is written to the file.

The system is now configured to receive remote data from an external device.

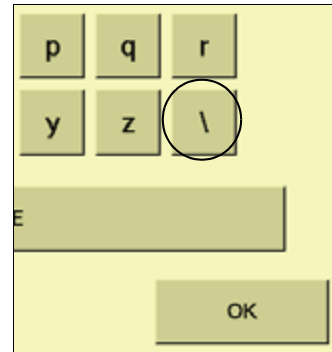



# The Productivity Monitoring Plugin

## In this chapter:

- Installation
- Configuring the Productivity Monitoring plugin
- Operation

The Productivity Monitoring plugin enables the FmX integrated display to interface with an Enalta CDA 1000 display, for sugar cane harvesting.

This chapter explains how to combine the two systems so that the information from both displays appears on the FmX integrated display.

*Note – To use this plugin, you must have an Enalta CCT system.*

## Installation

1. Install the FmX integrated display, harness, and GPS receiver. See [Installing the display](#), page 35.
2. Connect the Enalta sensors to a serial port on the FmX integrated display harness.

## Configuring the Productivity Monitoring plugin

1. Install the Productivity Monitoring plugin. See [Adding or removing a plugin](#), page 192.
2. On the *Configuration* screen, select the Productivity Monitoring plugin and then tap **Setup**:

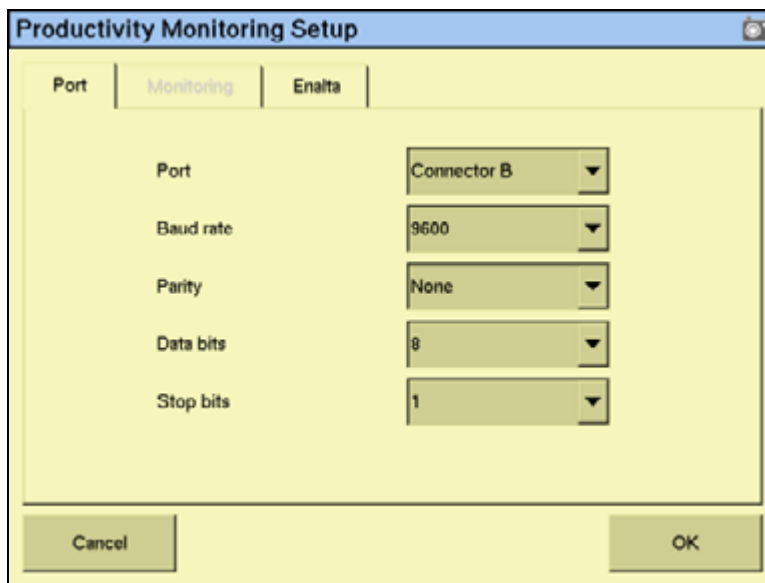

3. In the *Port* list, select the port on the FmX integrated display harness that the Enalta sensors are connected to.



4. Adjust the port settings.

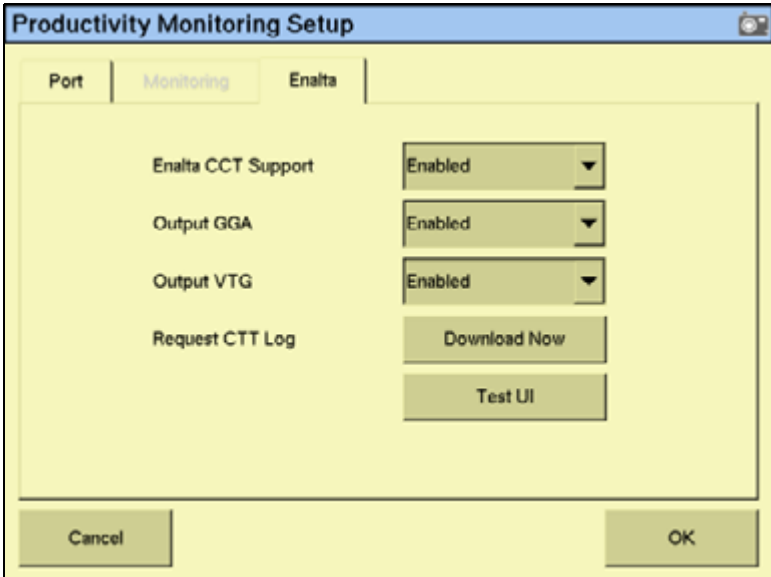

5. In the *Enalta* list select **Enable Enalta CCT** to enable the Enalta system.
6. Select the NMEA messages that the systems will use to communicate. You can select:
  - GGA: Select **Enable GGA**.
  - VTG: Select **Enable VTG**.
  - GGA and VTG messages: Select both buttons.
  - RMC
7. Enter the following settings:

Item	Description
Logging Rate While Field Open	The rate at which data is logged when a field is open. (1 sec–300 sec).
Logging Rate While Field Closed	The rate at which data is logged when the field is closed (1 sec–300 sec).
Minimum Operating Speed	When a field is open and the vehicle speed drops below this speed, a pop-up message appears onscreen asking the driver to select a reason for the low speed. The system will not operate until the driver selects a reason.
Maximum Stoppage Time	When a field is open and the vehicle stops moving for longer than this time, the system prompts the driver for reason for the stoppage. The system will not operate until the driver responds.
Productive When	The system is marked “productive” when a condition is active: <ul style="list-style-type: none"> <li>• None: The system is not productive.</li> <li>• Logging: On = productive; Off = non-productive</li> <li>• AP Engaged: Engaged = productive; Disengaged = non-productive</li> <li>• Minimum Speed: Above = productive; Below = non-productive</li> </ul>

## Operation

When you open a field, enter the additional details.

When the conditions that you set in the configuration are met, they trigger pop-up messages on the FmX integrated display.

# The Yield Monitoring Plugin

## In this chapter:

- Introduction
- General setup information
- Setting up the Yield Monitoring plugin
- Error messages
- Third-party display instructions
- Yield Monitoring Diagnostics

The FmX integrated display can access yield data that is collected by yield monitoring sensors.

This chapter describes how to configure the FmX integrated display for use with various yield monitoring platforms.

## Introduction





### Definitions



Term	Definition
Clean Grain Elevator	After grain has been separated from the rest of the plant, the clean grain auger moves the grain from the separator to the grain bin.
Grain Bin	The hopper on the combine that is filled with clean grain as harvest progresses.
Header Height	A sensor that indicates the position of the head.
Load	The load of grain that has been harvested.
OEM Moisture Sensor	A moisture sensor installed by the combine manufacturer.
Standard Bushel Weight	Commonly accepted density for a grain.
Standard Moisture Test Weight	Commonly accepted moisture for a grain.
Variety	The variety of grain that is being harvested.
Yield Monitoring	Module that interfaces between the yield monitoring sensors and CAN Module the FmX integrated display.

### Auto width detection

Auto width detection aids accurate area calculations by automatically reducing the cut width when entering or exiting point rows and other previously harvested areas.

If you are harvesting a row crop with pre-configured rows then the width reduces on an overlap by one row at a time.

Tap  or  at the bottom of the map screen to manually reduce the cut width; each time you tap the button, the cut width is reduced by one sixteenth of the head width. Tap  on the right-hand side to disable the rows from the right, or tap  on the left-hand side to disable rows from the left.

To re-enable the sections, tap  on the right-hand side to enable the rows to the right, or tap  on the left-hand side to enable the rows to the left.

## Operating the Yield Monitoring plugin

### Yield Monitoring Run screen

The Yield Monitoring run screen has two pages:

- Page 1 shows current information about an event and allows you to manipulate the materials and sections. You can edit the information that appears on this page.
- Page 2 shows the current data of the event. You can edit the information that appears on this page in the *Choose Status Items* tab.

The following shows the Yield Monitoring run screen with the Loads and Calibration page:

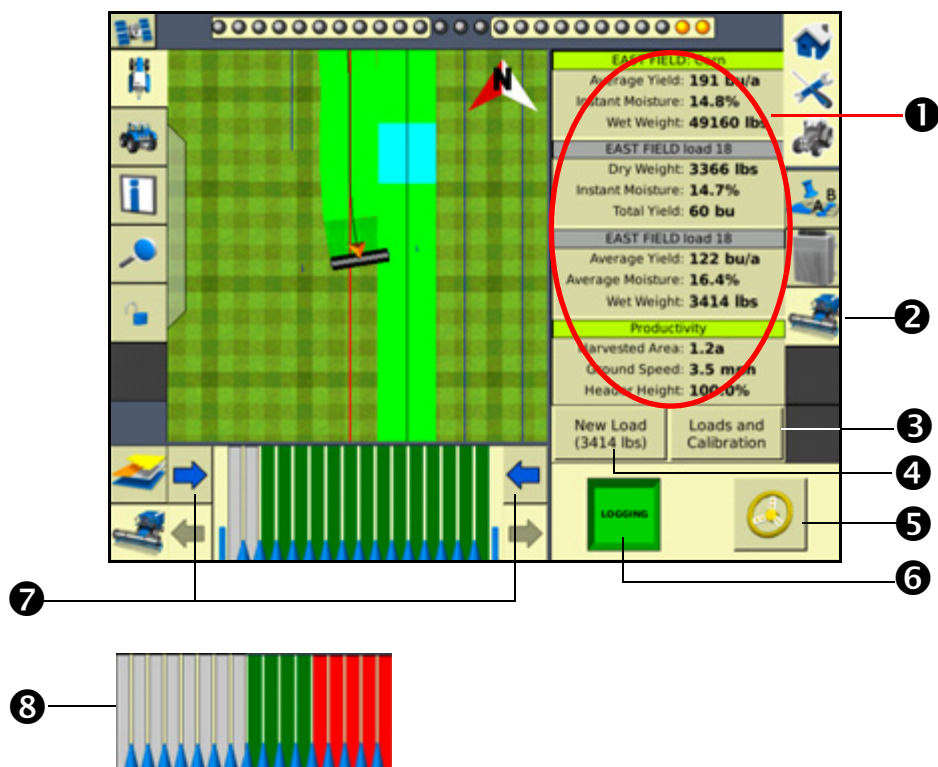

	Feature	Description
1	Current event information	Tap any item to make changes.
2	Yield Monitoring plugin icon	
3	Loads and Calibration	Tap to view loads and edit load names.
4	New Load / End Load	Tap to start new load or end current load.
5	Engage button	Green: Auto guidance engaged. Gray: Auto guidance can be engaged. Red: Auto guidance cannot be engaged.
6	Logging button	Green: Logging enabled. Red: Logging.
7	Enable and disable rows	Tap the left arrow on the right-hand side to disable logging on the rows from right to left. Tap the right arrow on the left-hand side to disable logging on the rows from left to right.

	Feature	Description
8	Row Status Indicator tab	Shows the logging status of each section of the combine heaser. Green: Harvesting and logging are working as normal. Red: Logging has been manually disabled. The swath area has been reduced by up to one sixteenth per red line. Grey: Active rows have overlapped a previously harvested area.

Tap a section to view more details:

Page 1 of the plugin tab

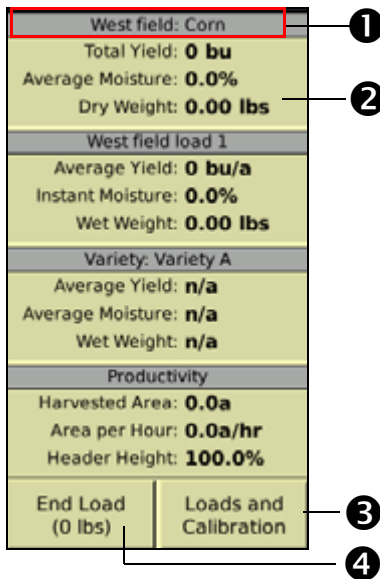

Page 2 of the plugin tab

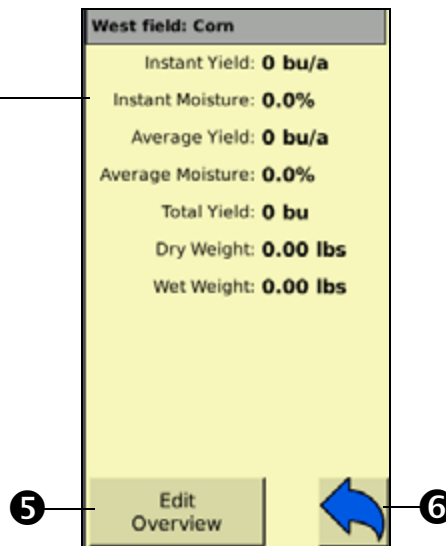

Load and Calibration tab

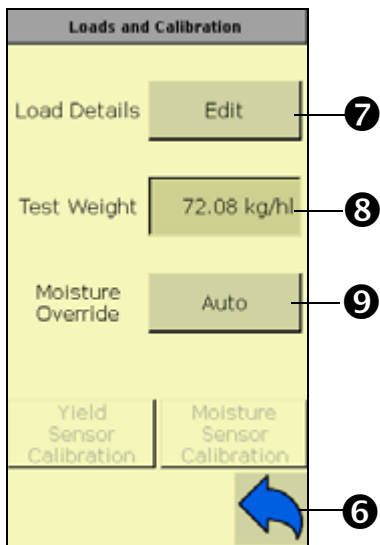

Choose Status Items tab

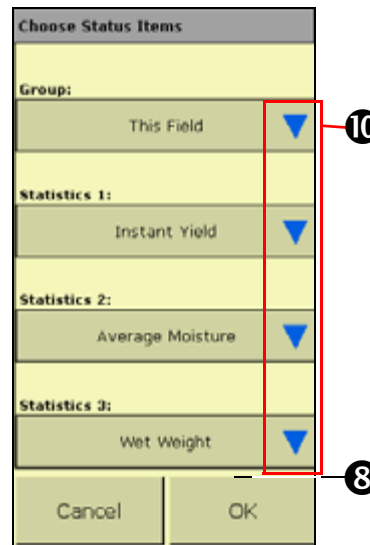

	Description
1	The name of the field and material you are harvesting.

	Description
②	Current information being displayed.
③	Tap <b>Loads and Calibration</b> to access the <i>Loads and Calibration</i> tab.
④	Toggle button: <ul style="list-style-type: none"> <li>• Tap <b>New Load</b> to start recording a new load.</li> <li>• Tap <b>End Load</b> to stop recording the current load</li> </ul>
⑤	Tap <b>Edit Overview</b> to access the Choose Status Items tab where you can edit the information that appears on this page.
⑥	Tap to return to the previous plugin screen.
⑦	Edit or delete <i>Load Details</i> .
⑧	Tap to enter the <i>Test Weight</i> .
⑨	Select <b>Auto</b> or <b>Manual Moisture Override</b> . If you select Manual, use the virtual keypad to enter the moisture value. This value is used until you select <b>Auto</b> .
⑩	Tap the blue arrow buttons to change the status items that you want to appear on Page 2 and then tap <b>OK</b> .

## General setup information

Before setting up the Yield Monitoring plugin on the FmX integrated display, ensure that:

- All components are installed on the vehicle.
- The Yield Monitoring plugin has been added to the FmX integrated display configuration. See [Adding or removing a plugin, page 192](#).
- The implement has been set up and configured for the appropriate operation. See [Chapter 7, Implement Configuration](#).

## Setting up the Yield Monitoring plugin

In the *Configuration* screen, select the *Yield Monitoring* plugin and then tap **Setup**.

- Setup, see [page 428](#)
- Operation, see [page 429](#)
- Crop, see [page 430](#)
- Map Legend, see [page 431](#)
- Serial, see [page 431](#)

The following yield monitoring systems are supported:

- Claas, 670 and 700 series (*North America only*)
- John Deere, -60 and -70 series
- Serial data input

*Note – The Serial tab is not available when you are setting up a Claas or John Deere module.*

## Setup tab

Enter information about the combine you are using:

Setting	Description
Combine	Select the brand of combine you are using.
Model	Select the model of combine you are using.
Yield Monitor Type	Select the type of yield monitor you are using: <ul style="list-style-type: none"> <li>• Claas</li> <li>• John Deere</li> <li>• Serial Data Input</li> </ul>
Port Connection	Select the port on the back of the FmX integrated display that the yield monitor is connected to.



## Operation tab

The screenshot shows the 'Yield Monitoring Setup' dialog box with the 'Operation' tab selected. The settings are as follows:

- Head Logging Height:** 50.00 % (with a 'Current Height' button next to it)
- Grain Flow Delay:** 8 s
- Reset Autocut:** When header is lifted (dropdown menu)
- Crop Overlap:** (button)

Buttons for 'Cancel' and 'OK' are located at the bottom of the dialog.

*Note* – The selections available on the Operations tab may vary depending on the yield monitoring type that you selected.

Enter settings to configure the combine you are using:

Setting	Description
Head Logging Height	The height at which yield data logging starts and stops. The Head Logging Height is read from the Header Height Sensor. If required, tap <b>Current Height</b> to enter values related to your own setup. <b>Note</b> – Head Logging Height is not available for the Claas 600/700. This is set by the CEBIS.
Grain Flow Delay	The amount of time in seconds that it takes for the grain to reach the yield sensor after it enters the head.
Reset Autocut	Controls when the rows are automatically reset <ul style="list-style-type: none"> <li>• <b>When head is lifted</b> automatically resets the rows at the end of the row when the head is lofted past the logging height.</li> <li>• <b>Never</b> disables Autocut. Rows must be controlled manually.</li> </ul>
Crop Overlap	When more than one crop variety is detected in the head, the system will stop accumulating variety statistics. Use this setting to adjust the percentage of crop overlap that is allowed before the system stops accumulating variety statistics. Select a value between 1% and 25%. For best results, the recommended setting is 10%.

## Crop tab

The screenshot shows a dialog box titled "Yield Monitoring Setup" with a yellow background. It has five tabs: "Setup", "Operation", "Crop", "Map Legend", and "Serial". The "Crop" tab is selected. Inside the dialog, there are four rows of settings:

- Commodity:** A dropdown menu showing "Corn".
- Units:** A dropdown menu showing "Bushels/a".
- Bushel Weight:** A text input field containing "56.00 lbs".
- Standard Moisture:** A text input field containing "15.50 %".

At the bottom of the dialog, there are two buttons: "Cancel" on the left and "OK" on the right.

Enter information about the crop you are monitoring.

Setting	Description
Commodity	Select the crop that is currently being harvested.
Units	Select the unit of measure for the crop type: <ul style="list-style-type: none"> <li>• Bushels/acre</li> <li>• Lbs/acre</li> <li>• Tons/acre</li> <li>• Hundred Weight/acre</li> </ul> <p><b>Note</b> – When this is selected, the Bushel Weight field is automatically set to 100 lbs.</p> <ul style="list-style-type: none"> <li>• Bushels/hectare</li> <li>• Kgs/hectare</li> <li>• Tonnes/hectare</li> </ul>
Bushel Weight	The weight of a single bushel of crop.
Standard Moisture	Set the cutoff point between a wet crop and a dry crop. Set these values depending on what you want the map to look like.

## Map Legend tab

Setting	Value
High Yield	250 bu/a
Low Yield	10 bu/a
High Moisture	20.5 %
Low Moisture	13.5 %

Enter information about the yield and moisture values that appear in the Yield Monitoring Run screen. See [page 441](#).

Setting	Description
High Yield	The highest expected yield for the current event.
Low Yield	The lowest expected yield for the current event.
High Moisture	The highest expected moisture for the current event.
Low Moisture	The lowest expected moisture for the current event.

## Serial tab

Baud Rate	38400
Parity	None
Data Bits	7
Stop Bits	1

Set the sensor output values.

Setting	Description
Baud Rate	
Parity	
Data Bits	
Stop Bits	

## Error messages

Error message	Cause	Resolution
State 1 - During boot up	<p><b>60 Series</b></p> <ul style="list-style-type: none"> <li>Moisture unit</li> <li>Head unit</li> <li>Armrest unit</li> </ul> <p><b>70 Series</b></p> <ul style="list-style-type: none"> <li>Moisture sensor</li> <li>CC1 unit</li> <li>Cab unit</li> <li>Corner post</li> </ul> <p><b>YM 2000</b></p> <ul style="list-style-type: none"> <li>Cannot detect YM 2000</li> <li>Serial port</li> </ul>	<ol style="list-style-type: none"> <li>Ensure that the correct cable is installed.</li> <li>Ensure the display is communicating with the CAN bus (system / diagnostics / serial port / Port A/B); is there another value other than zero for CAN messages?</li> <li><i>(60 Series Combines)</i> Check if Crop Type will change on the Greenstar display after Crop Type on the FmX has been changed.</li> <li><i>(70 Series Combines)</i> Change the Crop Type in the command center and make sure it changes on the FmX integrated display.</li> <li>Raise the head up or down to see if the display will show a change for header height.</li> <li>If Step 1 and Step 2 work, log field data.</li> </ol>
State 2 - During boot up	Never sees the armrest, header unit, moisture sensor, or reports which one is not visible by the FmX integrated display.	<ol style="list-style-type: none"> <li>Ensure the display is communicating with the CAN bus (system / diagnostics / serial port / Port A/B); is there another value other than zero for CAN messages?.</li> <li><i>(60 Series Combines)</i> Make sure Moisture Sensor has version 1.20C loaded.</li> <li><i>(60 Series Combines)</i> Check if Crop Type will change on the Greenstar display after Crop Type on the FmX has been changed.</li> <li><i>(70 Series Combines)</i> Change the crop type in the command center and make sure it changes on the FmX.</li> <li>Raise head up or down to see if the display shows a change for header height.</li> </ol>

Error message	Cause	Resolution
State 3 - During boot up	Will show which controller is not visible (armrest, header unit, moisture sensor).	<ol style="list-style-type: none"> <li>1. Ensure the display is communicating with the CAN bus (system / diagnostics / serial port / Port A/B); is there another value other than zero for CAN messages?.</li> <li>2. (60 Series Combines) Make sure Moisture Sensor has version 1.20C loaded.</li> <li>3. (60 Series Combines) Check if Crop Type will change on the Greenstar display after Crop Type on the FmX has been changed.</li> <li>4. (70 Series Combines) Change the crop type in the command center and make sure it changes on the FmX.</li> <li>5. Raise head up or down to see if the display shows a change for header height.</li> </ol>
State 4	FmX integrated display has lost communication from the CAN bus.	<ol style="list-style-type: none"> <li>1. Check cabling.</li> <li>2. Recycle Power (shut down the display and the combine and wait 20 seconds before powering the FmX and the combine back up).</li> <li>3. Make sure other logging devices are not connected to the CAN bus (disconnect Mobile Processor or GS2 display).</li> </ol>

Other reasons yield monitoring may not work include the following:



Reason	Cause	Resolution
FmX is not mapping.		<ol style="list-style-type: none"> <li>1. Make sure the display Header Height setting is lower than John Deere's setting.</li> <li>2. Ensure that the crop type is the same.</li> </ol> <p><b>Note</b> – The machine must be in normal harvesting operation mode.</p>
FmX stops mapping periodically through the field.	The header could be raising and lowering past the Stop Logging Header Height setting.	Increase the Header Height setting on the FmX.
FmX yield information does not match John Deere's information.	Different crop types may be selected.	Verify the crop types match in both displays.
Major jump, or extremely different weight values than shown on the John Deere monitor.	The Stop Head Height setting is lower than what the John Deere monitor shows. The John Deere monitor could be logging more data than the FmX logs, therefore showing a larger value.	Set the Head Height to 100% on the John Deere display.

## Third-party display instructions



### Setting up the Claas Cebis Quantimeter

*Note* – When using the Yield Monitoring plugin with Claas Quantimeter, always set the Autopilot Coverage Log setting to Manual. See [Configuring the Engage tab, page 107](#).

#### Crop Harvested setting

1. On the Cebis display, select  and then select .
2. Select  and then select the crop that you are harvesting.

#### Moisture Measuring setting

1. Select  and then select .
2. Select  and then adjust the following settings:
  - Status
  - Moisture correction
  - Display of yield with storage moisture
  - Adjust storage moisture
  - Display of current moisture

#### Bulk Density setting

1. Turn the HOTKEY dial to the scales icon:

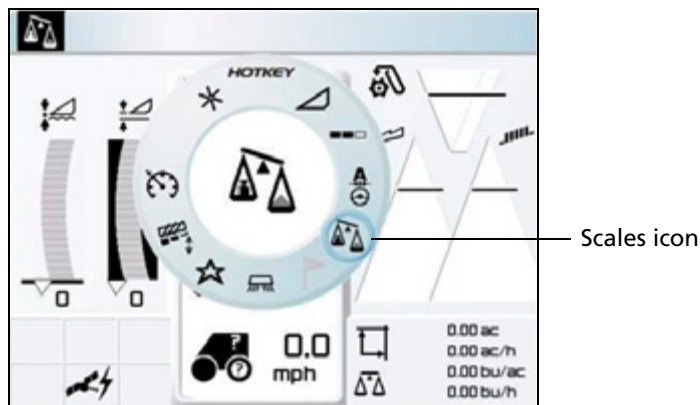



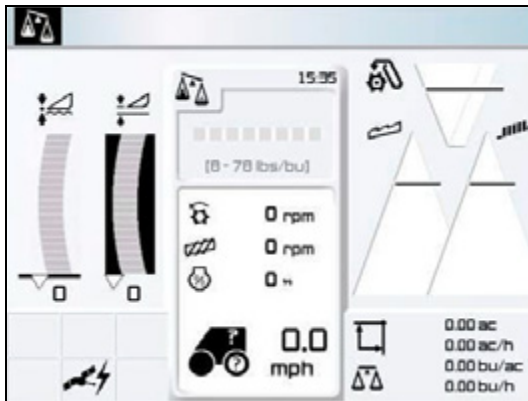

- Adjust the crop density by rotating the HOTKEY until the correct value appears on the screen:







*Note* – The lbs/bu value must be set before the Weight Measured function can be used.









### Zero Yield setting

- Select  and then select .
- Select  and then select .
- Tap **OK**.

### Zero Angle setting



- Select  and then select .
- Select  and then select .
- Tap **OK**.

## Calibrating the Claas Cebis Quantimeter





- Select  and then select .
- Select  and then scroll to **On**.
- Harvest a full grain tank or truck load.
- Once the tank or truck is full, select  and then select .
- Select  and then scroll to **Off**.
- Weigh the grain tank or truck to get a scale ticket.
- Select  and then select .
- Select  and then select *Crop yield weighted*. Scroll to increase or decrease the value until it matches the weight on the scale ticket.

## Calibrating the Claas Cebis Auto Pilot

### Activate the AutoPilot system

1. Select  and then select .
2. Select  and then scroll to **On**.



### Setting up the steering angle and steering system

1. Select  and then select .
2. Select  and then select .
3. Select *Learning sensing system*.



### Setting up the centralizing switch

1. Select  and then select .
2. Select , scroll left or right to adjust the central position and then select **OK**.

### Setting up the steering sensitivity

1. Select  and then select .
2. Select , scroll left or right to adjust the steering sensitivity and then select **OK**.

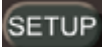
## Configuring the Stop Head Height on the Greenstar Monitor

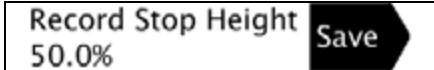
1. Press .
2. Press  for Harvest Monitor.
3. Position the header to 100%.
4. Press  next to Record Stop Height.

## Configuring the Stop Head Height on the Command Center

1. Navigate to Home screen on the Command Center.
2. Select the *Combine* icon  in the lower right corner of the screen.



- Press the 3rd button from the left on the command center to select the *Combine* tab.

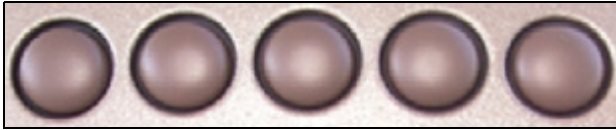

- After *Combine* tab is selected, continue to press the 3rd button from the left until page 3 appears (*page numbers are located on the Combine Tab*).





- Position the header to 100%.
- Press **Enter** on *Stop Head Height* screen to record the required stop header height.



## Calibrations

### **Original Greenstar Display (60 Series Combines)**

#### **Calibrate Moisture**

- Press **SETUP**
- Select **Yield Monitor** 
- View page 1. **SETUP Yield Mon PAGE 1**
- Check moisture with a certified tester.
- Calculate moisture correction (*certified tester reading minus the Greenstar reading*).
- Input the moisture difference. **Moisture Correction -3.0 Change** 

#### **Calibrate Yield**

- Press **SETUP**

2. Select 

3. View page 2. 

4. Verify that the combine's grain tank and the truck/wagon are both empty, and tap **Start**.

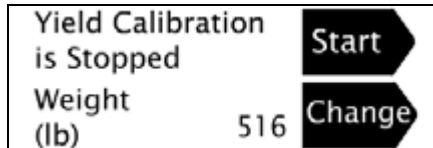

5. Harvest about 500 bushels, and hit **Stop**.

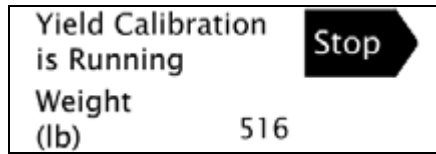

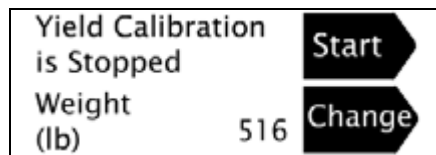

6. Unload the grain harvested during calibration onto truck/wagon.
7. Select button next change to enter the weight of the truck/wagon in wet pounds.



### **Command Center (70 Series Combines)**



#### **Calibrate Moisture**

1. Navigate to Home screen on the Command Center.
2. Select 
3. Press  on the Command Center
4. Continue to press  until page 2 appears (*page numbers are shown on the Wrench tab*).
5. In the *Calibrations* list, select Moisture.
6. Follow the steps to perform the calibration.



7. Highlight the arrow and then press the *Confirm* switch on the armrest.

**Calibrate Yield**

1. Navigate to Home screen on the Command Center.
2. Select .
3. Press  on the Command Center.
4. Continue to press  until page 2 appears (*page numbers are shown on the Wrench tab*).
5. In the *Calibrations* list, select Yield:

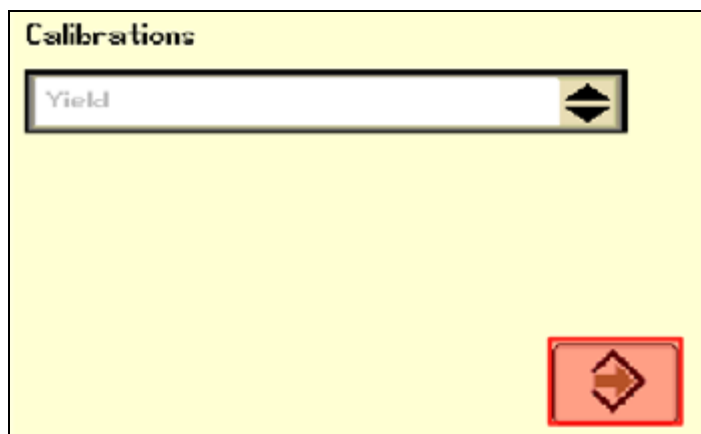





6. Follow the steps to perform the calibration.
7. Highlight the arrow and press the *Confirm* switch on the armrest.

**Updating the Moisture Sensor (60 Series combines only)****Downloading Version 1.20C from Stellar Support**

1. Go to [www.stellarsupport.com](http://www.stellarsupport.com).
2. Select *Support & Downloads* in the left column.
3. Select *Greenstar System* update from the *Software Downloads* column.
4. Select the green box labeled *Download GSD4 Software*.
5. Select **Run** in the file download security warning.
6. Once the download is complete, choose the preferred language and press **OK**.
7. Follow the Greenstar Update Wizard to load the firmware to the keycard for the original Greenstar monitor.

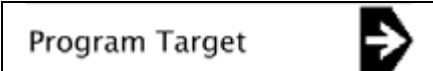
**Loading version 1.20C to the Moisture Sensor**

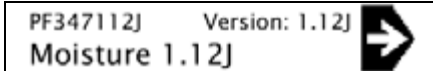
1. Insert the updated keycard into the mobile processor that is hooked to the Greenstar display (*it does not matter which slot the keycard is inserted in on the mobile processor*).
2. Power on the Greenstar monitor.
3. Press 
4. Select 
5. Select 
6. Select 
7. Select 
8. Disconnect the mobile processor after the update is complete.

## Yield Monitoring Diagnostics

Select the *Yield Monitoring* tab and then tap **Diagnostics**.

The *Yield Monitoring Diagnostics* screen contains two tabs, a Yield Monitor tab and an Inputs tab.

## Yield Monitor tab

Yield Monitoring Diagnostics	
Yield Monitor	Inputs
Volume liters	0.0 l
Weight (kg)	0 kg
Moisture	15.5 %
Header Height	100 %
Roll angle	0 deg.
Pitch angle	0 deg.
Flow (kg/hr)	0 kg/hr
Average duty cycle	0 %
Leaking light	0
Spontaneous pulse	0
Invalid duty cycle	0
Density	60.00 lbs/bu
Coefficient	1.0000
<input type="button" value="Reset Values"/>	
<input type="button" value="Calibration"/>	
<input type="button" value="Cancel"/> <span style="margin-left: 200px;"><input type="button" value="OK"/></span>	

## Inputs tab

Yield Monitoring Diagnostics	
Yield Monitor	Inputs
SG1	0.0 V
SG2	0.0 V
SG3	0.0 V
SG4	0.0 V
SG5	0.0 V
SG6	0.0 V
GL1	0.0 kHz
GL2	0.0 kHz
GL3	0.0 kHz
GL4	0.0 kHz
Optical 1	0.0 kHz
Optical 2	0.0 kHz
Optical 3	0.0 kHz
Hdr. Hght	0.0 V
Moist+	0.0 V
Moist-	0.0 V
Tmpr.	0.0 V
Moist. BP.	0.0 kHz
IMU X	0
IMU Y	0
IMU Z	0
ESPD1A	0.0 kHz
ESPD1B	0.0 kHz
ESPD2A	0.0 kHz
ESPD2B	0.0 kHz
Moist.	0.0 kHz
Tmpr. 1	0.0 V
Tmpr. 2	0.0 V
Tmpr. 3	0.0 V
<input type="button" value="Cancel"/> <span style="margin-left: 200px;"><input type="button" value="OK"/></span>	

## VRS Plugin for DCM-300 and Ag3000 Modems

### In this chapter:

- DCM-300 modem
- Ag3000 modem

This chapter describes how to install and configure the DCM-300 or Ag3000 modem to work with the FmX integrated display.

## DCM-300 modem

### Introduction to the DCM-300 modem

The DCM-300 modem enables the FmX integrated display to receive RTK corrections from a Trimble VRS network, a third-party RTK provider, or a Continuously Operating Reference Station (CORS).

### Benefits of using a DCM-300 modem

The benefits of using the FmX integrated display and the DCM-300 modem include the following:

- More acres of RTK accuracy from Trimble VRS Now delivered to your display.
- Easy interface and configuration with the display.
- Roof-mounted high-gain cellular antenna for enhanced signal reception to minimize cell phone signal related drop outs.
- On-screen wireless status and diagnostics.
- The DCM-300 modem is a rugged and sealed 3G communications solution for customers who need reliable communications for their farming operations.
- The DCM-300 modem is available with a HSDPA modem for use with GSM wireless networks globally, or an EVDO modem for use with the Verizon wireless network in the USA.



## Connecting the DCM-300 modem

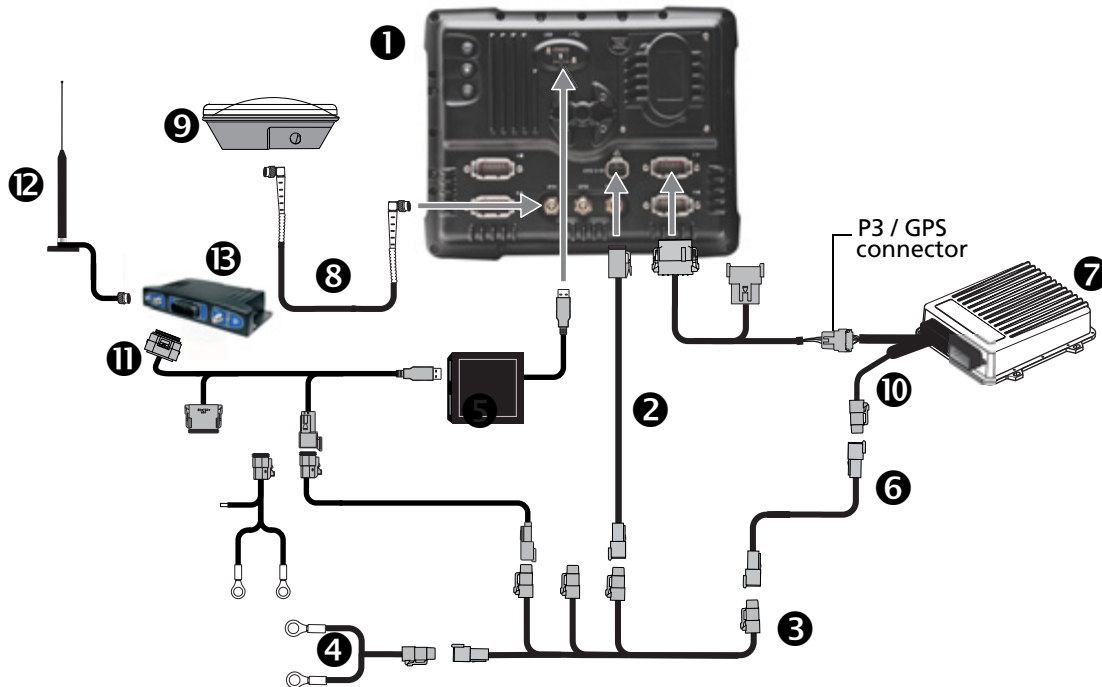

**CAUTION** – Connecting the Port Replicator on the FmX to NavController II cable 5 to the P4 or P12 connector of the NavController II harness 10 will result in damage to the FmX integrated display, and will void the warranty.

Item	Description	Trimble part number
1	FmX integrated display	93100-01
2	FmX power cable	66694
3	FmX power cable with relay and switch (power bus)	67259
4	Basic power cable	67258
5	FmX to NavController II cable with port replicator	75741
6	2 pin DTM to 2 pin DT power adaptor	67095
7	NavController II	55563-00
8	8m GPS TNC/TNC RT angle cable	76442
9	AG25 GNSS antenna	68040-005
10	Main NavController II cable	54601
11	DCM-300 to display cable	82033
12	DCM-300 cellular antenna	72122 + 51227
13	DCM-300 modem	83x00-10

## Unlocking the DCM-300 modem with passcodes

The DCM-300 modem is available at different prices for Asset Tracking and VRS/File Transfer. The VRS/File Transfer functionality in the DCM-300 modem must be unlocked to use VRS or data transfer. To unlock the DCM-300 with a passcode, you must connect the modem to the FmX display and then turn it on. The *Unlock* screen shows the DCM-300 when connected; enter the passcode in the FmX display and then tap **OK** to send it to the modem. When the modem is successfully unlocked, a message appears on the FmX display—reboot the modem.

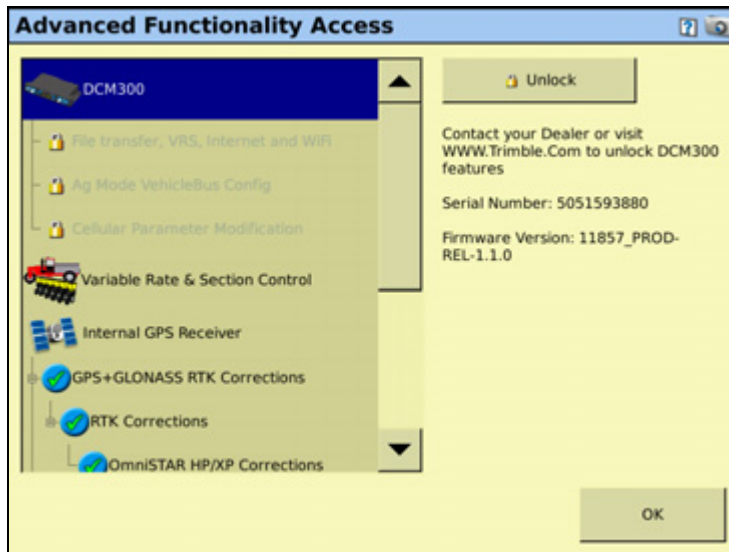

## Activating the DCM-300 modem

The DCM-300 modem is available with either an HSDPA modem for use with GSM cellular networks globally, or an EVDO modem for use with the Verizon wireless network in the United States. Trimble offers services for the DCM-300 modem that can be purchased from a Trimble store. Services include the VRS Now Ag correction service, Sync data transfer, Dispatch asset tracking, and wireless data plans (USA only).

## Configuring the DCM-300 modem

1. Install the VRS plugin. For more information, see [Adding or removing a plugin, page 192](#)).
2. To use VRS corrections the *GPS Setup* tab must be configured with a *Correction type* of Trimble VRS.

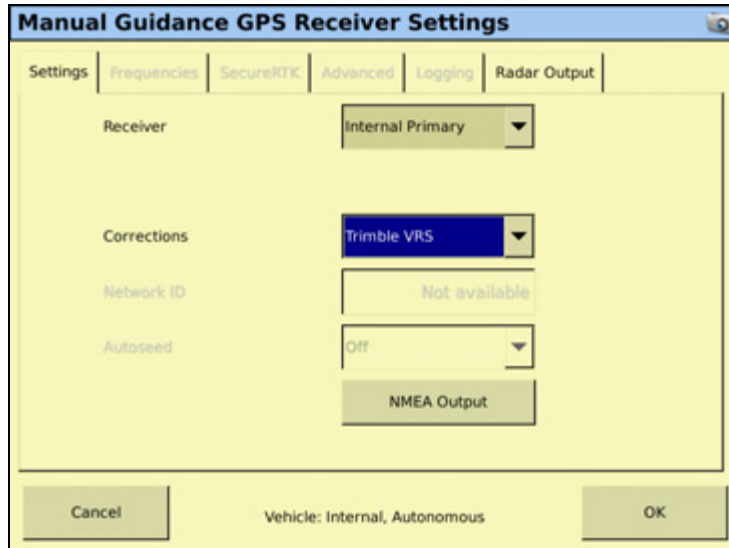

**Note** – The FmX display must be unlocked for RTK to use the Trimble VRS correction type.

3. From the *Configuration* screen, select the VRS plugin and then tap **Setup**. The *VRS Configuration* screen appears:

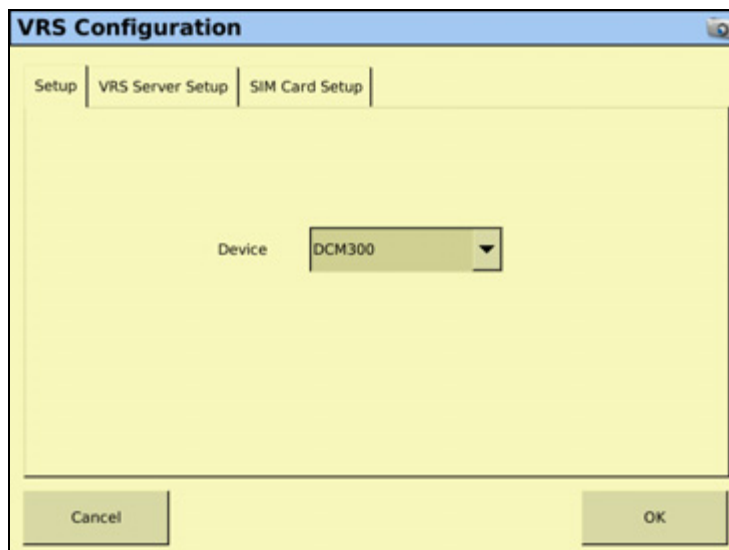

4. From the *Device* drop-down list, select the type of modem that is connected. The default is *DCM-300*.

5. Select the *VRS Server Setup* tab:

The screenshot shows a dialog box titled "VRS Configuration" with three tabs: "Setup", "VRS Server Setup" (which is selected), and "SIM Card Setup". The "VRS Server Setup" tab contains the following fields and values:

- Server Name/Address: 155.63.211.99
- Server Port Number: 2170
- Mount Point: TVN\_AG\_GNSS
- User Name: bsmith
- Password: [masked with dots]

At the bottom of the dialog, there are "Cancel" and "OK" buttons.

6. Enter the required settings, as provided by your Trimble VRS Now or Network RTK operator, as described below.

Internet base setting	Description
Server Name/Address	RTK/VRS/CORS base station broadcast name
Server Port Number	Base station port number
Mount Point	Base station mount point
User Name	Assigned username
Password	Assigned password

7. Tap **OK**. The *Configuration* screen appears.

The DCM-300 modem is now configured.

**Note** – *SIM Card Setup* tab:

- In the USA, the DCM-300 modem comes with an AT&T SIM card; if you subscribe to the Trimble AT & T or Verizon data plans you do not need to enter the details.
- If you supply your own SIM card, you must obtain details of the SIM card from the card provider and then enter them here.
- The SIM card setup is only used for the DCM-300G modem; the DCM-300C modem for Verizon does not use the SIM card setup tab.

## Ag3000 modem

### Introduction to the Ag3000 modem

The Ag3000 modem enables the FmX integrated display to receive RTK corrections from a Trimble VRS™ network, a third-party RTK provider or a Continuously Operating Reference Station (CORS).

### Connecting the Ag3000 modem

The following figure shows how to connect the FmX integrated display to the Autopilot Automated Steering System while using corrections from the Ag3000 modem.

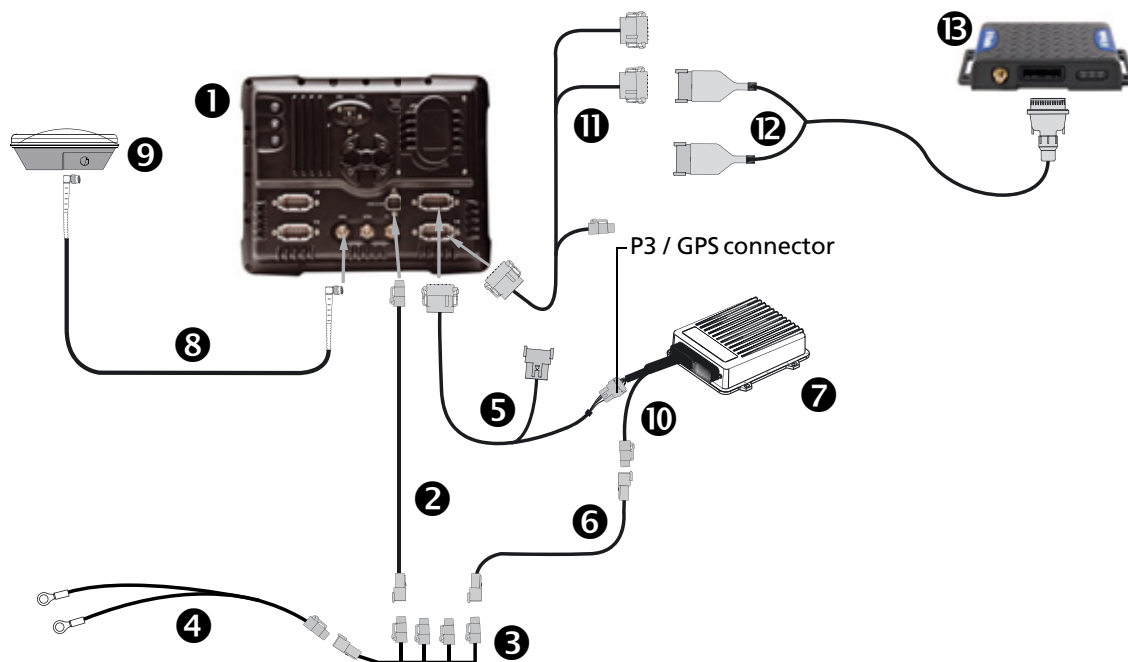

**CAUTION** – Connecting the Port Replicator on the FmX to NavController II cable 5 to the P4 or P12 connector of the NavController II harness 10 will result in damage to the FmX integrated display, and will void the warranty.

Item	Description	Trimble part number
1	FmX integrated display	93100-01
2	FmX power cable	66694
3	FmX power cable with relay and switch (power bus)	67259
4	Basic power cable	67258
5	FmX to NavController II cable with port replicator	75741

Item	Description	Trimble part number
⑥	2 pin DTM to 2 pin DT power adaptor	67095
⑦	NavController II	55563-00
⑧	8m GPS TNC/TNC RT angle cable	76442
⑨	AG25 GNSS antenna	68040-00S
⑩	Main NavController II cable	54601
⑪	Ag3000 to FmX/FM-1000 cable	77273
⑫	Ag3000 break-out cable	70433
⑬	Ag3000 modem	80300

### Activating the Ag3000 modem

In the USA, the Ag3000 is bundled with a Trimble-installed AT&T card, which is tied to your Ag3000 unit and cannot be separated. You cannot use any other SIM cards with this device.

Additionally, the Ag3000 modem does not work in a CDMA network.

Outside of the USA, you must contact your local VRS Now or third-party cell provider for a SIM card.

### Configuring the Ag3000 modem

1. Install the VRS plugin. For more information, see [Adding or removing a plugin, page 192](#)).
2. From the *Configuration* screen, select the VRS plugin and then tap **Setup**.

The *VRS Configuration* screen appears:

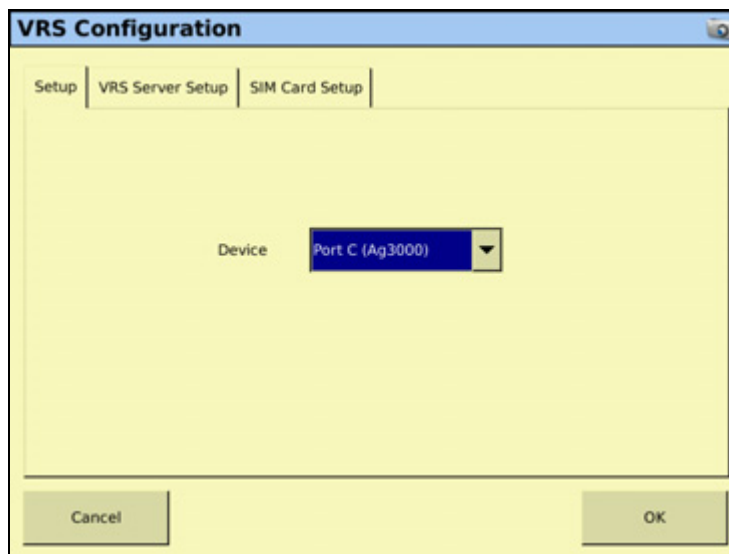

3. From the *Port* drop-down list, select the FmX port that the Ag3000 modem is connected to. The default setting is *DCM-300*.
4. Select the *VRS Server Setup* tab:

The screenshot shows the 'VRS Configuration' dialog box with the 'VRS Server Setup' tab selected. The fields are as follows:

Field	Value
Server Name/Address	155.63.211.99
Server Port Number	2170
Mount Point	TVN_AG_GNSS
User Name	bsmith
Password	•••••

5. Enter the required settings, as provided by your Trimble VRS Now or Network RTK operator, as described below.

Internet base setting	Description
Server Name/Address	RTK/VRS/CORS base station broadcast name
Server Port Number	Base station port number
Mount Point	Base station mount point
User Name	Assigned username
Password	Assigned password

6. Tap **OK**. The *Configuration* screen appears.

The Ag3000 modem is now configured.

**Note** – *SIM tab fields:*

- *In the USA, the Ag3000 modem has an AT&T card; you do not need to enter the details.*
- *Outside of the USA, you must obtain details of the SIM card from the card provider and then enter them.*





## The EZ-Remote Joystick

### In this chapter:

- [Requirements](#)
- [Installation](#)
- [Enabling the EZ-Remote Joystick](#)

This chapter describes the EZ-Remote joystick, which is a programmable, external device that controls the functions of the FmX integrated display.

If you use the EZ-Remote joystick, you do not need to tap buttons on the FmX integrated display. This improves your accuracy when you select buttons, and gives you faster reaction times.

## Requirements

- FmX integrated display
- EZ-Remote joystick

## Installation

For installation information, see the EZ-Remote Joystick Quick Reference Card.

## Enabling the EZ-Remote Joystick

1. Connect the EZ-Remote joystick into Port B on the back of the display. An EZ-Remote joystick icon automatically appears on the *Configuration* screen.
2. From the *Configuration* screen, select *EZ-Remote* and then tap **Setup**. The *EZ-Remote Assignment* screen appears:

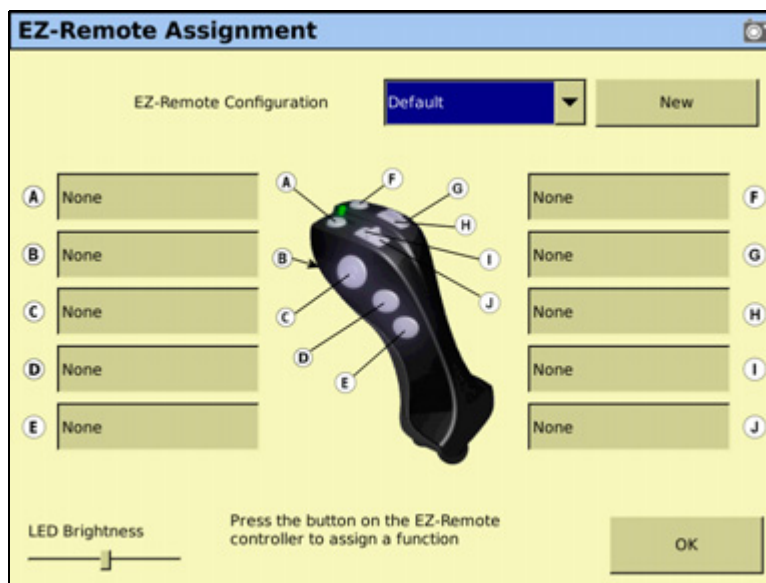

3. In the *EZ-Remote Assignment* screen, you can configure each key for the function you want to control remotely. You can also adjust the brightness of the LED joystick buttons.

- On the EZ-Remote joystick, press the first button you wish to program. The Function Assignment screen appears:

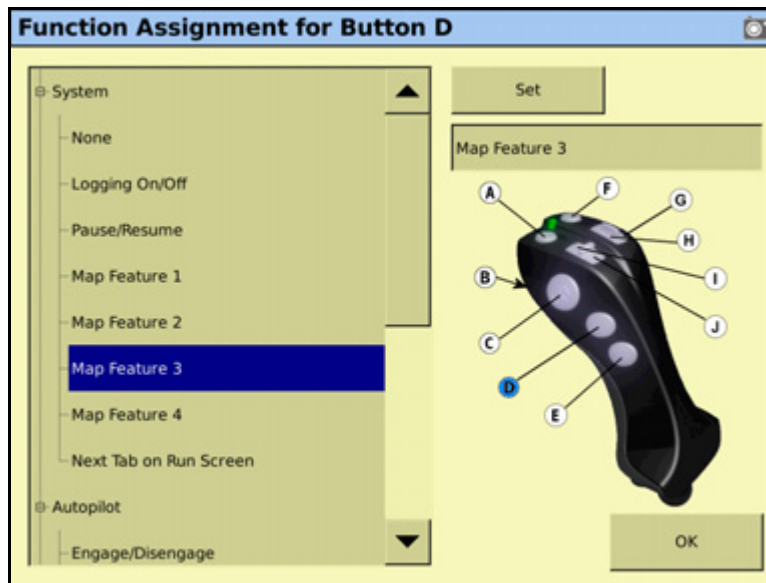

- Tap the feature that you want to program into that button on the control joystick.
- Tap **Set** and then tap **OK**. The *Keypad Assignment* screen appears again.
- Repeat [Step 3](#) through [Step 6](#) to program more buttons as required.
- When completed, tap **OK**.

**Note** – You can configure the EZ-Remote control joystick while operating in a field. From the Run screen, tap the Configure button  and then follow the steps above.

**Note** – The functions available to assign to each button depend on which plugins are activated on the FmX integrated display.



## The LB25 External Lightbar

### In this chapter:

- [Configuring the lightbar](#)

This chapter describes how to configure the LB25 external lightbar to operate with the FmX integrated display.

## Configuring the lightbar

1. Connect the LB25 lightbar to port B on the rear of the FmX integrated display.
2. From the Home screen, tap .
3. In the *Current Configurations* screen, tap **Configure**.
4. Select the System option and then tap **Setup**.
5. From the *Display Setup* screen, select *Lightbar* and then tap **Setup**.

In the *Light Bars Configuration* screen the virtual lightbar from the FmX integrated display is shown ❶, along with any detected external lightbars ❷:

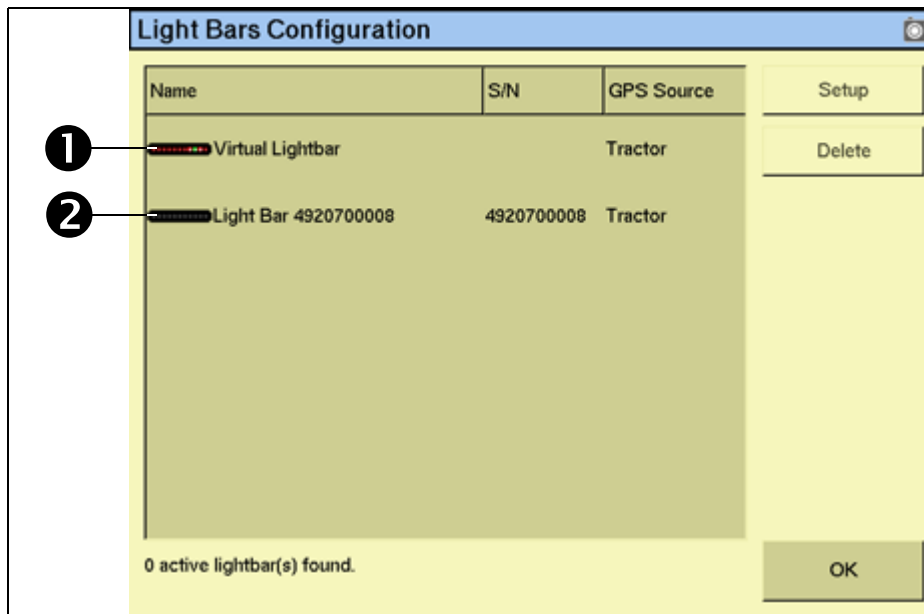

6. Select an external lightbar and then tap **Setup**:

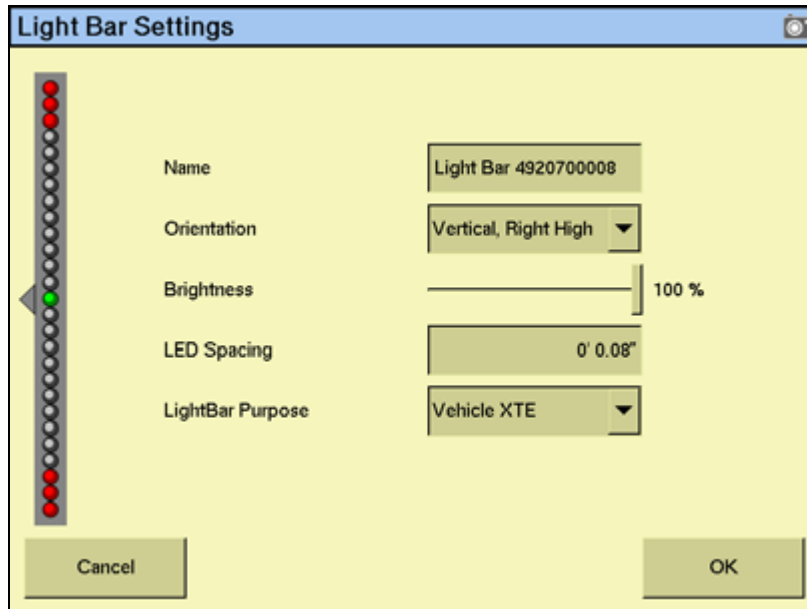

7. Enter the required settings and then tap **OK**. The *Light Bars Configuration* screen appears.
8. Tap **OK**.

The external lightbar is now configured.





# Advanced Configuration

## In this chapter:

- Configuring remote coverage logging
- Changing the password
- Saving the vehicle configuration
- Saving a PDF version of the current field
- Upgrading the FmX integrated display firmware
- Upgrading the Field-IQ system firmware
- Unlocking additional devices

Once you complete the basic configuration, you can:

- Use this chapter to configure more advanced features for higher accuracy or better performance.
- Begin driving. See [Getting Started](#).

***Note** – Some configuration settings are unavailable when a field is open in the Run screen. To access these settings, return to the Run screen and then tap the Home button. When the display prompts you to close the field, tap **Yes**.*

## Configuring remote coverage logging

You can configure the FmX integrated display to control coverage mapping by using a switch on the implement instead of the button on the Run screen.

### Installing the logging option

To connect an implement switch to the FmX integrated display and configure the display to use the switch to control the logging, install a switch on the implement to allow for correct switch activation when the implement is raised or lowered. For example, a switch similar to the Trimble P/N 60477S (shown below), can be used to activate the coverage logging:

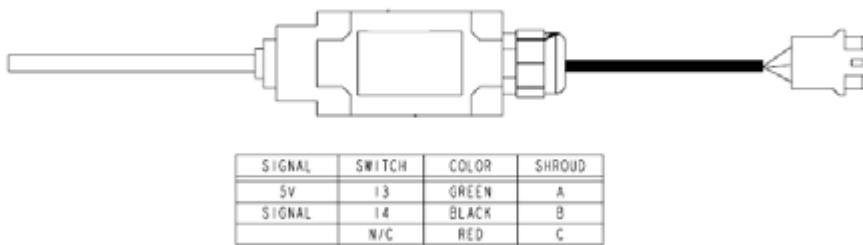

The switch must make and break the connection on pins 10 and 11 on the FmX port connector.

For example, to use the 60477S switch:

1. Connect pin A of the switch to pin 10 of the 12-pin Deutsch connector on Port A or Port B of the display.
2. Connect pin B of the switch to pin 11 of the 12-pin Deutsch connector on Port A or Port B of the display.

Doing this results in the connection being made between pins 10 and 11 of Port A or B of the display when the implement is raised or lowered.

**Notes** – *If Ports A or B are used by other cabling, you can use the port replicator on the cable to connect the remote logging switch.*

– *If you use a different switch, the connections may be different than described in this example.*

A relay must be used to control coverage logging when voltage is present at the switch. The following schematic shows the relay between the display and the switch:

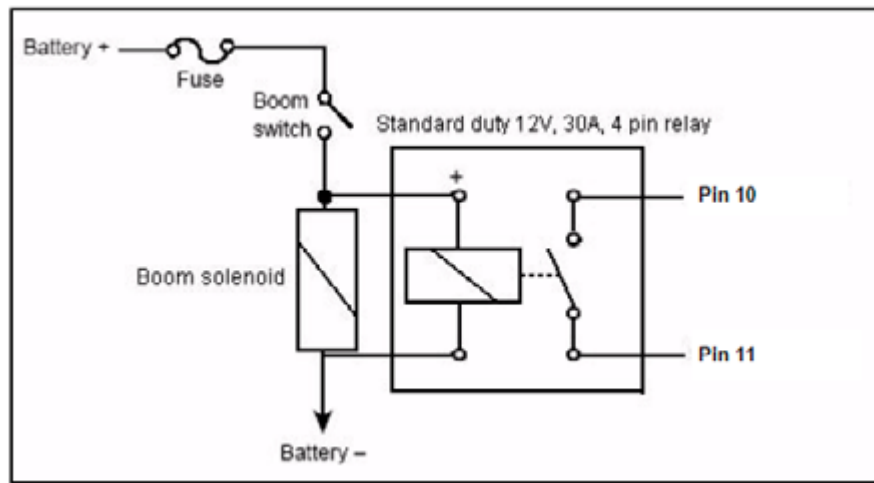

For more information on configuring the implement, see [Adjusting the implement settings](#), page 184.

## Enable the external switch

To enable the external switch:

1. From the Home screen, tap .
2. Tap **Configure**.
3. Select the implement and then tap **Setup**.
4. Select the *Extras* tab.
5. In the *Remote Log Switch* list, select either Connector A or Connector B.
6. In the *Logging When* list, select either High or Low:

Item	Description
Logging when high	The system records logging when the switch is turned on and stops recording when the switch is turned off.
Logging when low	The system records logging when the switch is turned off and stops recording when the switch is turned on.

**Note** – When remote logging is set to Connector A or Connector B, the **Logging** button on the Run screen is disabled. Use the external switch to turn logging on or off.

## Changing the password

*Note* – To change the Administration password, you require the Master password. If you do not know it, contact your local Trimble reseller. See also [Password access, page 73](#).

1. Do one of the following:
  - If you have not entered the password during the current session, tap **Setup** or **Calibrate** from the *Configuration* screen.
  - If you have already entered the password during this session, tap the Home button and then tap **Lock Configuration**. On the *Configuration* screen tap **Setup** or **Calibrate**.

The *Enter Administration Password* screen appears.

2. Enter an *incorrect* password. The *Wrong Password* screen appears.
3. Tap **Enter Master Password**.
4. Enter the Master password and then tap **OK**. The *Change Administration Password* screen appears.
5. Enter your new Administration password in both fields.

The new Administration password is now active.

## Locking the display (to re-enable the password)

To re-enter the password if you have already entered the Administration Password:

1. From the Home screen, tap .
2. Tap **Configure**.
3. Tap **Lock Config**.
4. Tap **Setup** or **Calibrate**. The *Enter Administration Password* screen appears.

## Saving the vehicle configuration

*Note* – The vehicle configuration is different from the display and implement configuration. The vehicle configuration saves the Autopilot vehicle settings that you **created**. The display configuration saves the display appearance features that you **selected**, and the implement configuration saves each implement including plugins and physical attributes.

1. From the *Configuration* screen, select the Autopilot option and then tap **Setup**. The *Vehicle Controller Setup* screen appears.
2. Edit the vehicle settings and tap **OK**.
3. Tap **Save Config**.

To overwrite a previous configuration file, tap **Switch Config** and then select the previous file from the *Vehicle Configuration* list.

4. To save the file, tap **OK**.
5. Tap **Save Config**.

Before the configuration file is saved, the following message appears:

You are about to overwrite the existing Vehicle Configuration. Do you want to Save or create a New Configuration. Tap either Save to overwrite or New to create a new configuration file.

## Saving a PDF version of the current field

When you close a field, the system automatically creates a PDF summary file. The PDF is saved to the `|AgGPS|Summaries|<client_farm_field_event>|` folder:



Smith\_Ranch  
Farm3  
ne2-8-33  
STRIPTILL

Event Details	
Operator	
Event Created	2008-Apr-05 19:03:21
Summary Created	2010-Oct-05 21:55:27
Latitude/Longitude	39°23'21.48"N 100°57'39.60"W
Field Area	0.00 a
Total Boundaries Area	0.00 a
Total Time	14hr 42m
Operator EPA License	
Harvest Year	
Farm Location	
Crop	
Material	
Target	
Application Method	

Coverage Layers	
Layer 1 - UNKNOWN	
Coverage Time	7hr 21m

Equipment	
Vehicle	Not Available
Implement	UI DEMO
Implement Width	40' 0" (Offset 0' 0")
Application Width	5' 0"
Rows	16

**NOTE:**

Totals are approximate values and may not be acceptable for customer invoice. Consult local laws and regulations for customer invoicing procedures - some regions require official weighing.

The Event Summary file may include the following images of the field:

This image ...	Shows the ...
Overlap	coverage and any overlaps
Height	vertical height of the GPS position
Applied rate	volume at which the spray boom applied solution
GPS quality	quality of the GPS signal
Average XTE coverage layer	degree of implement drift

The file also shows information about:

- The event
- The vehicle setup

Tap the appropriate buttons to show or hide coverage area and/or area features. If any Prescriptions are available, a prescriptions button is also available.

To view a summary report on an office computer:

1. Remove the CompactFlash card from the display and then insert it into an office computer.
2. Select the folder `\AgGPS\Summaries\` and then open the file `Index.html`.
3. Select the appropriate field from the list.

*Note – If you use the Microsoft® Internet Explorer® internet browser, you may need to allow ActiveX® technology to see all of the summary file.*

## Upgrading the FmX integrated display firmware

1. Transfer the new firmware file from [www.trimble.com](http://www.trimble.com) to your office computer.
2. Connect the FmX integrated display USB memory stick to your office computer.
3. Unzip the firmware file and then save it to the root folder of the USB memory stick.
4. Insert the USB memory stick into the USB socket on the rear of the FmX integrated display.
5. Press the Power button on the rear of the display to turn on the FmX integrated display and then wait for the Home screen to appear.
6. Tap **Upgrade**. The *Firmware Upgrade* screen appears.
7. Select a firmware file from the *Firmware* list and tap **Upgrade**.
8. Once the upgrade is complete, tap **OK**. The system restarts.

## Upgrading the Field-IQ system firmware

You can use the display to upgrade the firmware in the following components:

Plugin	Item
Field-IQ	Master Switch Box 12 Section Switch Box Rate and Section Control Module Seed Monitoring Module Section Control Module Rate Control Module Rawson Control Module

To upgrade a component's firmware:

1. Transfer the new firmware file from [www.trimble.com](http://www.trimble.com) to your office computer.
2. Connect the FmX integrated display USB memory stick to your office computer.
3. Copy the firmware upgrade file to the *Firmware* folder on the USB memory stick.
4. Insert the USB memory stick into the USB socket on the FmX integrated display.
5. Press the Power button on the rear of the display to turn on the FmX integrated display and then wait for the Home screen to appear.
6. Tap **Upgrade**:

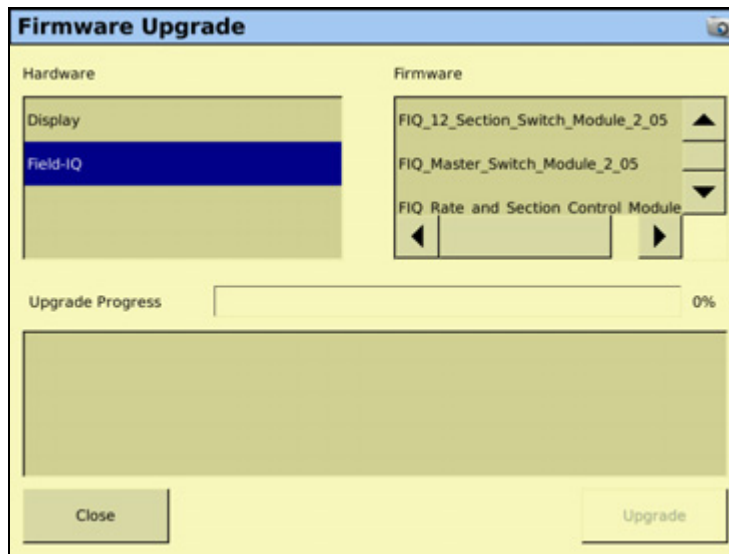

7. Select the appropriate plugin from the *Firmware* list. Any available firmware upgrade files appear in the upper right list.
8. Select the appropriate firmware file.
9. Once the upgrade is complete, tap **OK**. The system restarts.

The component's firmware is updated.

## Unlocking additional devices

You can purchase enhanced features for the FmX integrated display from your local Trimble reseller.

To enable the additional features, do the following:

1. Turn on the FmX integrated display. The Home screen appears.
2. Tap **Unlocks**:

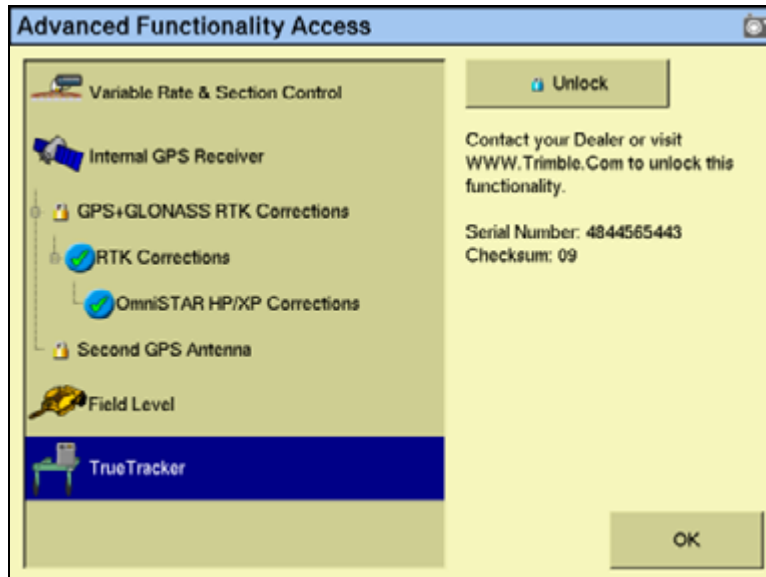

3. Tap the button for the feature that you want to unlock. The *Enter Password to Activate* screen appears.
4. Enter the password and then tap **OK**. The feature is enabled. The password is saved to the memory for future use.



# Data Management

## In this chapter:

- Transferring data to an office computer
- Data formats
- Folders on the USB memory stick
- Files on the USB memory stick
- Importing AB Lines or boundaries
- Data dictionaries

This chapter describes the files and folders on the FmX integrated display USB memory stick.

## Transferring data to an office computer

All field data collected by the FmX integrated display is saved onto the USB memory stick.

To transfer data to an office computer:

1. Remove the USB memory stick from the FmX integrated display.
2. Insert the USB memory stick into your office computer.



---

**CAUTION** – If you place the files in a series of folders, the combined filename and folder path may become too long and the operating system may not allow you to open the files. To avoid this, it is recommended that you place data in your computer's C:\ folder.

---

3. Copy the appropriate folder to the office computer using an application such as Windows<sup>®</sup> Explorer. This copies all the sub-folders and files in the folder.

*Note* – When you copy or move files using Windows Explorer, you must keep all the shape-files (.dbf, .shp, and .shx) together so that office software can open the theme file. To ensure that the files stay together, always copy the entire folder rather than just the individual files.

If you create a new event in a field, and you already have the |Field| folder containing any previous events on the office computer, you should still copy the |Field| folder so that the new EventHistory information is copied across.



---

**CAUTION** – If you use the same farm, field, or event names on more than one display, you could accidentally overwrite existing files when you copy data to the office computer. To prevent this, create a separate folder for each unit. For example:

C:\AgGPSFMD\_SN123456\  
C:\AgGPSFMD\_SN123457\  
C:\AgGPSFMD\_SN123458\

---

## Data formats

The FmX integrated display uses the Environmental Systems Research Institute (ESRI) 3D shape-file format for storing the layers of graphical information collected in the field (for example, spray coverage, track logging points, and features). The three files in a shapefile “set” are:

- The <filename>.dbf file, which contains the feature attributes.
- The <filename>.shp file, which contains position information.
- The <filename>.shx file, which is an index file that links the position information with its attributes.

In this manual, the term *shapefile* is used to refer to the three files collectively.

The FmX integrated display records all latitude, longitude, and height data in decimal degrees.

***Note** – The FmX integrated display reads and writes ESRI ArcView version 2.0 or 3.1 3D polylines, polygons, and points. The M and Z entity types introduced in ArcView 3.1 can be generated in the track logging files, but cannot be read by the FmX integrated display. For more information, go to the ESRI website ([www.esri.com](http://www.esri.com)).*

## Editing files

ESRI shape (.shp) and attribute (.dbf) files can be used in many other software packages that can import or use .shp and .dbf formats.

The Farm Works<sup>®</sup> software is recommended. For more information, go to [www.farmworks.com](http://www.farmworks.com).

Data collected by the FmX integrated display can be opened directly into the Farm Works software. You can make changes to the files and save them on an office computer.

Do not save changes back to the USB memory stick as this could mean that you cannot select the field with the FmX integrated display.

The Microsoft Excel<sup>®</sup> spreadsheet software and most database software also let you open and view the data in the attribute (.dbf) file.

## Generating files in the office

The FmX integrated display can load files that you created in office software. Save Shapefile or Agfile (.gdx) prescriptions to the `\AgGPS\Prescriptions\` folder on the card to send rates to a variable rate controller.

## Folders on the USB memory stick

This list shows:

- The names and types of files containing mapping and logging information.
- The folder where the FmX integrated display saves these files on the USB memory stick.

Data	Description	Files	folder
Field AB Line	Boundary and/or AB Lines polylines	Swaths.shp Swaths.dbf Swaths.shx	Field\ For more information, see <a href="#">Field folder, page 475</a> .
Field boundary	Polygon	Boundary.shp Boundary.dbf Boundary.shx	
Event history	Event information	EventHistory.dbf	
Point features	Attribute ID and latitude, longitude, and height	PointFeature.shp PointFeature.dbf PointFeature.shx	
Line features	Line with attribute ID	LineFeature.shp LineFeature.dbf LineFeature.shx	
Area features	Area polygons with attribute ID	AreaFeature.shp AreaFeature.dbf AreaFeature.shx	
Coverage	Series of polygons	Coverage.shp Coverage.dbf Coverage.shx	Event\ For more information, see <a href="#">Event folder, page 477</a> .
Track	Series of 3D points with attributes	Track3D_<date time>.shp Track3D_<date time>.dbf Track3D_<date time>.shx	
Summary	HTML	<eventname>_Summary.txt	AGPS\Summaries\ <client_farm_field_event\ </client_farm_field_event\  For more information, see <a href="#">Event folder, page 477</a> .
Diagnostic	Folder files	ProgramLog.txt ProgramLog.old (FmX integrated display logs) FaultLog.txt (Autopilot faults) service messages messages_.gz messages_.gz.1...9 (Operating system logs) core.gz (Debug data) <Date>	Diagnosics\ 

Data	Description	Files	folder
Yield	Yield points with attribute ID	TaskData.xml TLG<xxxxx>.bin TLG<xxxxx>.bin	\TaskData\
	Autopilot config	Vehicle.cfg	\Diagnostics\Autopilot\
	System settings	<Preferences>.xml	\Diagnostics\Preferences\
	-	Screenshot_<num>.png	\Diagnostics\screenshots\

## The AgGPS folder

The \AgGPS\ folder stores system utility files and subfolders that contain the input and output files of the FmX integrated display. See [Prescriptions, page 67](#) and [Folders on the USB memory stick, page 472](#).

The following diagram shows system utility files and the data folders in the \AgGPS\ folder saved on a USB memory stick by the FmX integrated display:

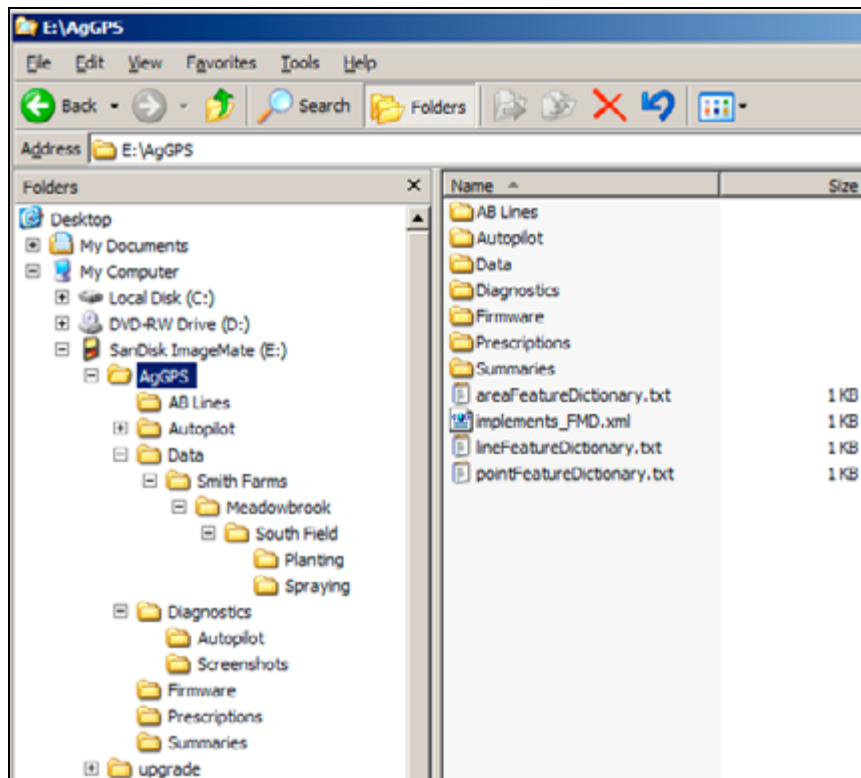

## Client folder

The `|Client|` folder stores a sub-folder for each farm defined for the client.

The following diagram shows the `|Client|` folder and file organization:

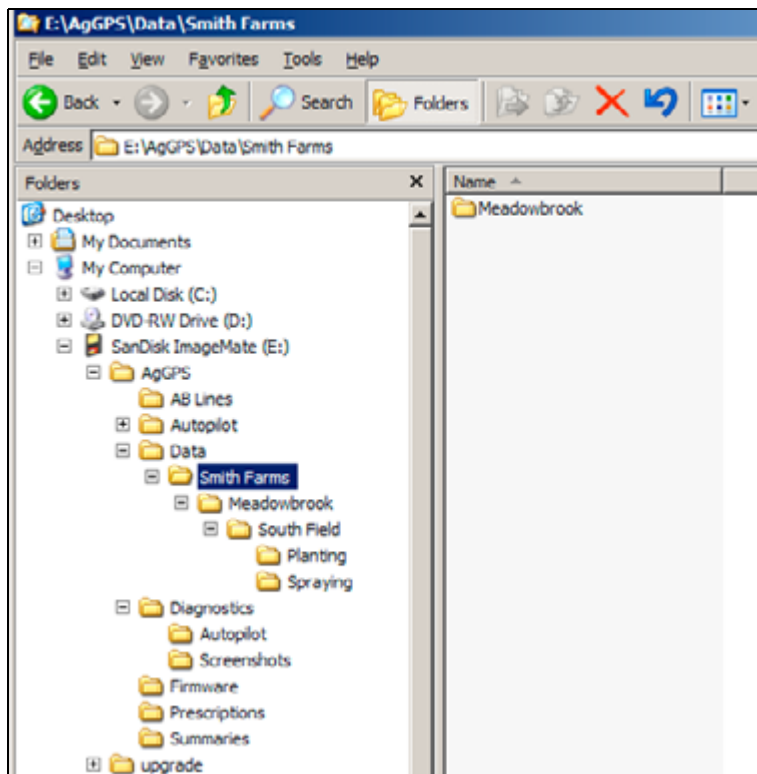

## Farm folder

The  $\backslash Farm$  folder stores a subfolder for each field defined for the farm.

The following diagram shows the  $\backslash Farm$  folder and file organization:

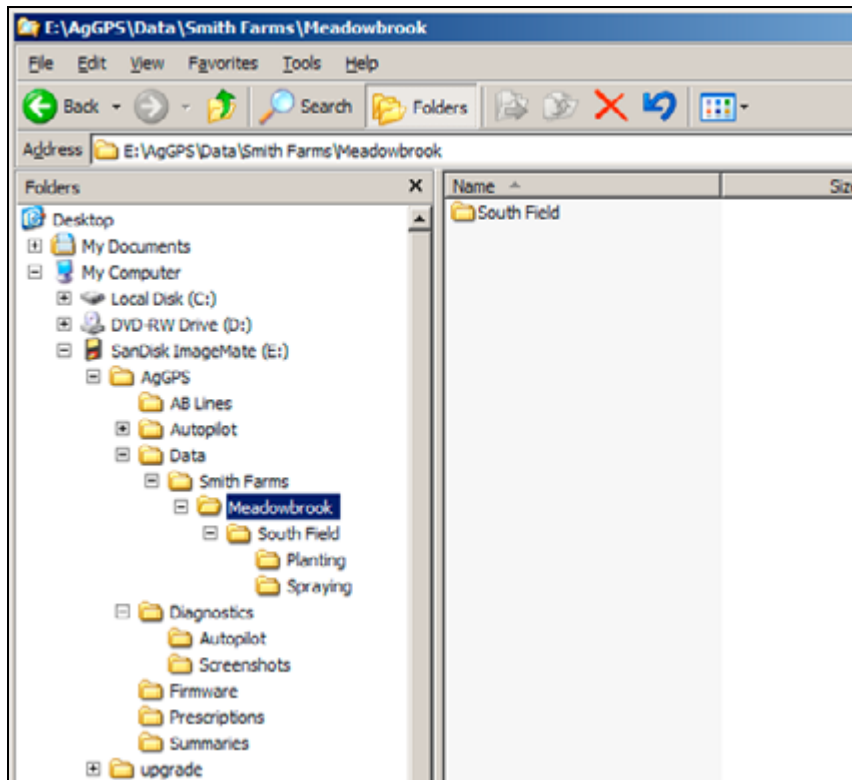

## Field folder

Each  $\backslash Field$  folder stores:

- A subfolder for each event performed on the field. See [Event folder, page 477](#).
- Three Swaths files.
- If it is a bounded (headland) field, three Boundary files. See [Field boundary and AB Line files, page 478](#).
- An empty file whose name represents the coordinates of the field boundary file ( for example: 172.000E43.000S12H.pos locates the boundary at latitude 172.000 East, longitude 43.000 South, and altitude 12 m high).
- Any recorded features files. See [Features files, page 481](#).
- Any paused files. See [Pausing guidance, page 64](#).
- The field event history file: EventHistory.dbf. It contains information about each event carried out in the field. See [Event History file, page 480](#).

The following figure shows how a *\Field* folder and its files are organized:

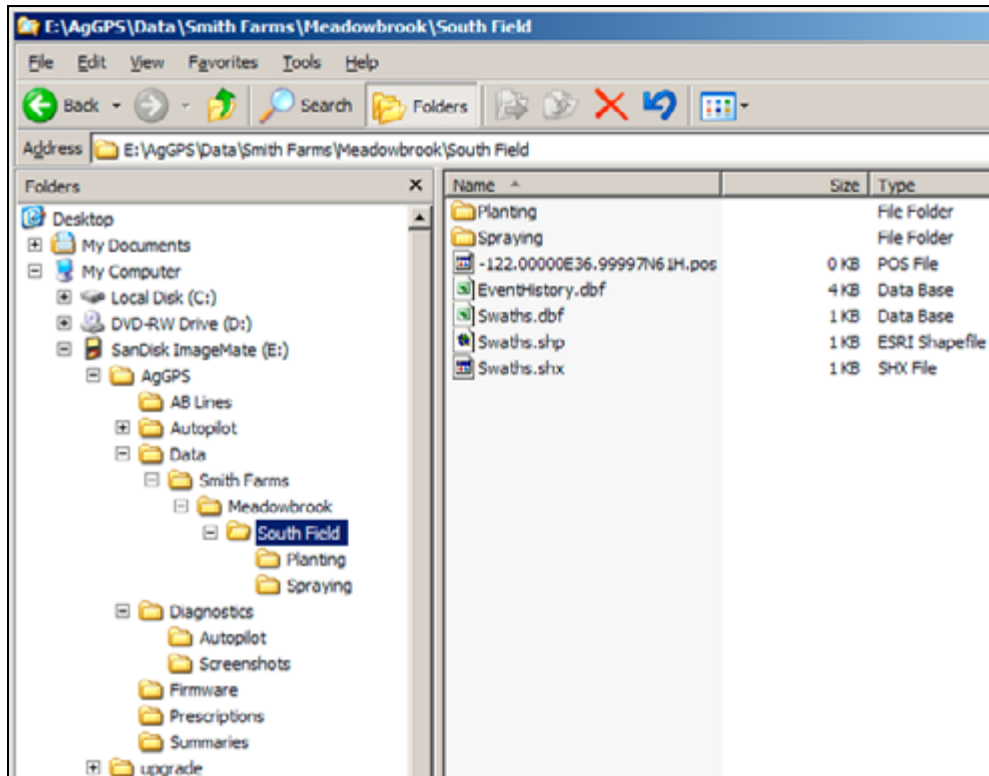



## Event folder

Each `|Event|` folder stores:

- Coverage logging shapefiles that are recorded during the event, called Coverage.\*. See [Coverage logging data, page 479](#).
- Track logging shapefiles that are recorded during the event, called Track3D\_<date time>.\*.

The following figure shows how an `|Event|` folder and its files are organized:

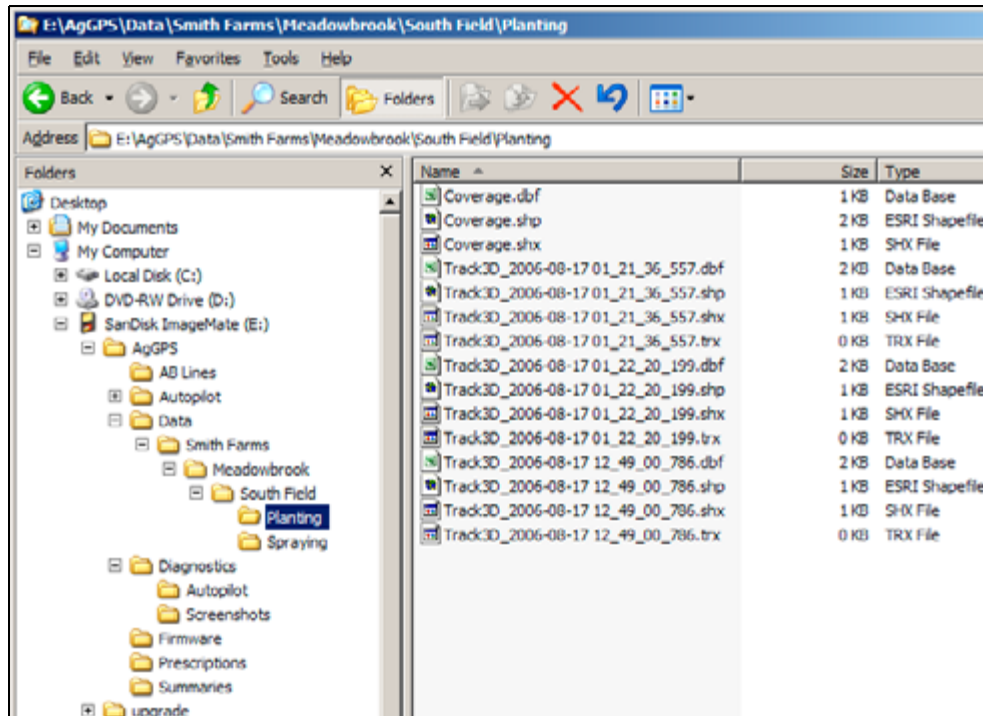

## TaskData folder

The TaskData directory contains yield data collected in the ISO11783 BIN format, which is read by Farm Works and other precision Agriculture software titles.

## Files on the USB memory stick

### Field boundary and AB Line files

There is one set of boundary and AB Line shapefiles for each field called:

- Boundary.\*
- Swaths.\*

Information stored in the Boundary.shp file for fields with boundaries includes a boundary polygon. Fields without boundaries do not contain a boundary file.

Information stored in the Swaths.shp file for fields with boundaries includes AB polylines.

Units are always metric in files created by the FmX integrated display.

The following information is stored in the boundary and ABLine attribute files.

Column	Field description	Notes
Date	Date the field was created	YYYYMMDD
Time	Field creation time (local time, am/pm format)	hh:mm:ss
Version	Boundary or ABLine attribute file version	
ID	AB Line number ID	
Name	Name assigned to the AB Line	
Area	Field area (Boundary area)	ha
Perimeter	Field perimeter distance (Boundary only)	meters
Length	Length of the AB Line	meters
SwathsIn		
Dist1		
Dist2		
PrefWeight		

Unless a field has a boundary, the size of the field is not defined. Therefore, for fields without boundaries the `%_Complete` in the EventHistory.dbf file is always zero.

**Note** – If you browse the .dbf files using an Excel spreadsheet, date fields may appear in a different format, depending on your local settings.

## Coverage logging data

Coverage logging files are created when any application coverage is recorded. For each coverage-polygon, the following information is saved to the coverage logging file.

Column	Field description
Version	Coverage attribute file version
GPS_Status	Numeric GPS status value
Status_Txt	GPS status description
Swath	The current swath number when coverage was recorded
Height	Height in meters
DateClosed	Date the polygon was closed
TimeClosed	Time the polygon was closed
AppliedRate	Applied rate reported by the variable rate controller
Speed	Average GPS ground speed for the polygon (in meters per second)
XTE	Implement Cross Track Error (in meters)
AppType	Application type ID

## Track logging files

Track logging files are created whenever the event is opened. See [Track logging files, page 76](#). At each point, a number of attributes are recorded.

The units stored in the track attribute file (Track3D\_<date time>.dbf) are in metric units.

The following information is stored for each point, in the track logging attribute file.

Column	Field description	Units/notes
TRACK_ID	Date and time stamp	–
Version	Track attribute file version	–
UTC_Date	Point creation date	YYYYMMDD
UTC_Time	UTC time	hh:mm:ss.s
Local_Time	Local time	hh:mm:ss.s
Logging_On	Coverage logging Flag (1=on, 0=off)	On or off
Auto_Steer	Auto-Steer Flag (1=on, 0=off)	On or off
GPS_Status	GPS status value	1 to 12
Status_Text	GPS status description	–
Num_Stats	Number of GPS satellites	–
DOP	Horizontal Dilution of Precision – a measure of the quality of positions based on satellite geometry	–
Corct_Age	DGPS signal correction age	seconds
Ant_Lat	Antenna latitude (WGS-84)	DD.dddddddd
Ant_Long	Antenna longitude (WGS-84)	DD.dddddddd
Height	Mean sea level height of ground	meters
Ant_HAE	Antenna height above ellipsoid	meters

Column	Field description	Units/notes
Ground_HAE	Ground height above ellipsoid	meters
Speed	GPS derived ground speed	kph
Heading	Direction of travel with respect to true North.	decimal degrees
Swath_Num	Current swath/headland number.	
Offline	Offline distance from swath center line.	meters
Along_Line	Along Line distance from start of swath.	meters
Swath_wdth	Swath width	meters
Appln_Wdth	Application width	meters
Units	Units	metric
Field_Name	The name of the field	–
Target	The target rate at the current position	–
Pitch	The pitch	–
Roll	The roll	–
Yaw	The yaw	–
Target	The target application rate when serial rate control, TAC or Field-IQ are used.	
As applied	The actual rate applied by the rate control system when serial rate control, TAC or Field-IQ are used.	
NDVI	The NDVI values recorded when using the GreenSeeker plugin. <b>Note – Not currently implemented.</b>	
Total_Qty	Total volume of material as applied for the current field. Only supported for the Aerial Flow Controller, Autocal Flow controller, and Crophawk Flow Meter.	–
Relative_Height	Height	meters

## Event History file

The EventHistory.dbf file contains information on every event carried out in the field:

Data	Description
Version	FmX integrated display firmware version
Client	Client name
Farm	Farm name
Field	Field name
Event	Event name
Operator	Operator name
Material	Material name
Date open	Date the field was opened
Time open	Time the field was opened
Date close	Date the field was closed
Time close	Time the field was closed
Duration	Length of time that the field was open (seconds)

Data	Description
PrimaryAB	Number of the primary AB Line
ABLine	
Cover area	Area covered
Cover distance	Distance covered
Cover time	
Engage time	Time engaged

## Features files

When features are recorded in the field, each type of feature is saved in three feature shapefiles in the *|Field|* folder as follows:

These features...	Are saved in these files...
Point	PointFeature.*
Line	LineFeature.*
Area	AreaFeature.*

One row of data is stored in the *<type>.dbf* file for each feature of that feature type recorded in the field. The following information is stored in the *<type>.dbf* file for each feature.

Column	Field description	Notes
Date	Date the feature was created.	yyyy/mm/dd
Time	Time the feature was recorded.	hh:mm:ss.s
Version	Features attribute file version.	
ID	Feature ID	
Name	Feature name	
Area	Field area (Area only)	ha
Perimeter	Field perimeter distance (Area only)	meters
Length	Length of the AB Line.	meters
SwathsIn		
Dist1		
Dist2		
PrefWeight		
Only recorded in point features:		
Latitude	Antenna latitude	decimal degrees
Longitude	Antenna longitude	decimal degrees
Height	Ground mean sea level height at antenna position. If you are mapping on a slope, the height may be wrong.	meters
AlarmRad	Alarm radius	meters
WarningRad	Warning radius	meters
Status_Txt	GPS status	meters

## Program Log message file

The FmX integrated display performs checks:

- when the display is turned on or off
- periodically, while running

This information is saved to the ProgramLog.txt file, which is in the `\AgGPS\Diagnostics\` folder. When this file becomes larger than 1024 KB, it is backed up to a file called ProgramLog.old.

The ProgramLog.txt file may be useful for troubleshooting. The file can be read with a text editor such as Notepad.

## Importing AB Lines or boundaries

The FmX integrated display can load field boundaries and AB Lines, created by an AgGPS 170 Field Computer, Remote Data Logger (RDL), or a Geographic Information System (GIS).

To load GIS boundaries, files must be in WGS-84 latitudes, longitudes, and heights in decimal degrees.

Use the following method to import an AB Line or a boundary into the FmX integrated display:

1. Attach the USB memory stick to an office computer.



---

**CAUTION** – The three files that define a line or field (.shp, .shx, and .dbf) must have identical names. Otherwise, they are not recognized. If you put multiple sets of files in the folder, ensure that you do not have more than one set of files with each name or your files will be overwritten.

---

2. Copy the following files to the `\AgGPS\AB Lines\` folder on the USB memory stick:
  - `<field name>.shp`
  - `<field name>.shx`
  - `<field name>.dbf`
3. Start the FmX integrated display and then tap **Run**.
4. Do one of the following:
  - Open an existing field.
  - Start a new field.
5. Tap **Swaths**.

6. Tap **Import**:

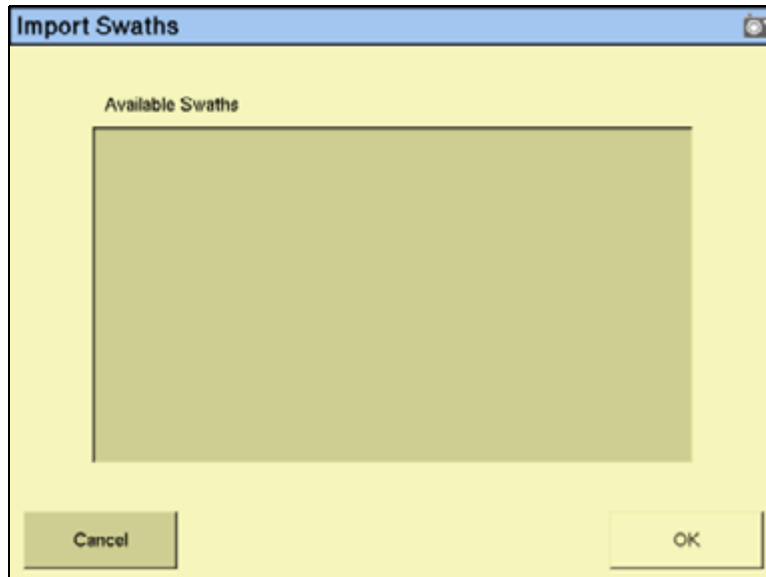

7. Select the field or AB Line to import from the list of available swaths and then tap **OK**. The field or AB Line is imported:

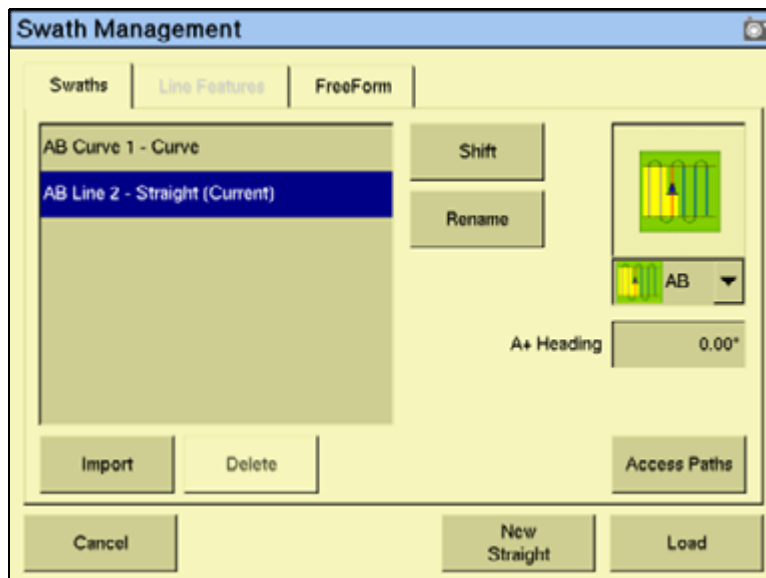

If the AB Line file contains more than one AB Line, all AB Lines in the file are imported.

8. Select the AB Line that you want to use and then tap **Load**. A warning message appears.
9. Tap **OK**. The imported field or AB Line is ready to use.
10. For best results, close the field and then reopen it.

## The Prescriptions folder

For each prescription that you generate, the `\AgGPS\Prescriptions\` folder stores three prescription files in ESRI shapefile format, or a single .gdx file.

The shapefiles required are the .dbf, .shp, and .shx files. Some GIS software packages generate other files and include different contents in the files; if they are on the USB memory stick, they are ignored.

The names and types of files that are used to supply input information to the FmX integrated display, and the folder where these files must be located on the card, are as follows.

Data	Description	Files	folder
Prescription files	Polygons ESRI shapefiles  AgInfo GDX	<code>&lt;prescriptionname&gt;.shp</code> <code>&lt;prescriptionname&gt;.dbf</code> <code>&lt;prescriptionname&gt;.shx</code> <code>&lt;prescriptionname&gt;.gdx</code>	<code>\AgGPS\Prescriptions\</code> For more information, see <a href="#">Prescriptions, page 67</a> .

The following figure shows the contents of a `\Prescriptions\` folder:

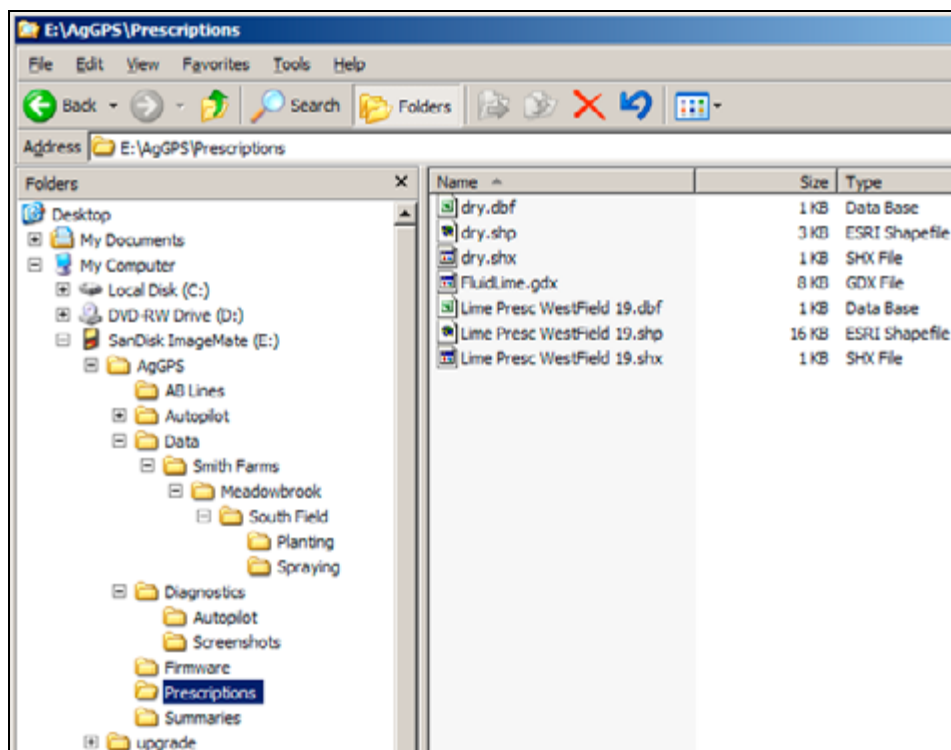



## Copying or deleting data files

The *Data Files* screen enables you to copy or delete card data. It shows the fields, varieties, prescriptions, and data dictionaries that are in the internal memory and on the USB memory stick.

On the FmX integrated display, there are two methods to access the *Data Files* screen. See the following sections:

- [Accessing data files from the Home screen, page 485](#)
- [Accessing the data files through the Configuration screen, page 485](#)

### Accessing data files from the Home screen

From the Home screen, tap **Data Files**. The *Data Files* screen appears:

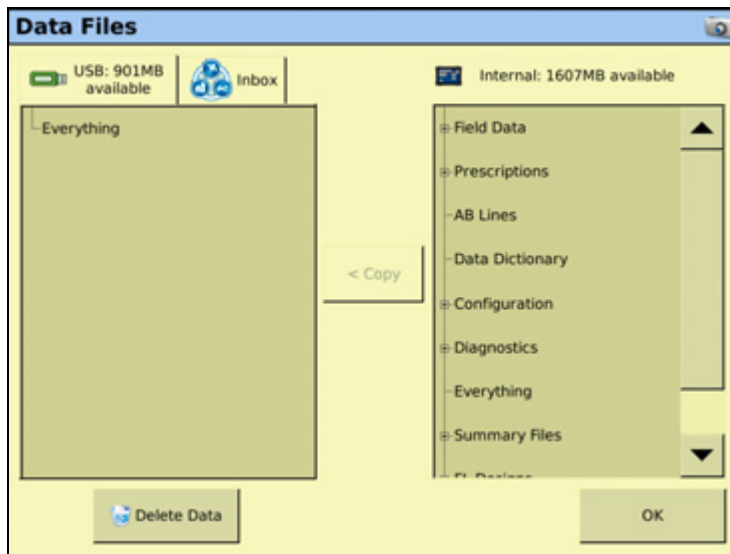

### Accessing the data files through the Configuration screen

1. From the Home screen, tap .
2. On the *Current Configurations* screen tap **Configure**.
3. On the *Configuration* screen select System and then tap **Setup**.
4. If necessary, enter the administration password and then tap **OK**.
5. Select *Data Files* from the list and then tap **Manage**. The *Data Files* screen appears.

## Copying data

To copy data from the USB memory stick to the internal memory or from the internal memory to the USB memory stick:

1. From the list, select the item to copy:
  - If the item is in the *USB* list, the **< Copy** button becomes available.
  - If the item is in the *Internal Storage* list, the **Copy >** button becomes available.
2. Tap **Copy**. The data is copied to the other column.

To copy data from the current USB memory stick (the source) to another USB memory stick (the destination):

1. Copy all of the data from the source to the internal memory.
2. When copying is complete, remove the source from the USB slot and then insert the destination.
3. Copy all of the data from the internal memory to the destination.

## Deleting data

If you need to create more space, you can use the FmX integrated display to:

- Delete any unused clients, farms, fields, events, or all of the data in the internal memory
- Delete any unused clients, farms, fields, events or all of the data on the USB memory stick

### Deleting selected data from the internal memory



---

**CAUTION** – Deleting data is permanent. You cannot undo the deletion or restore the data.

---

1. From the *Configuration* screen, select System and then tap **Setup**.
2. If necessary, enter the administration password and then tap **OK**.
3. Select *Data Files* from the list and then tap **Manage**. The *Data Files* screen appears.
4. Tap **Delete Data**. The *Delete Data Storage* screen appears.
5. In the *Delete Data* storage tabs, select Internal Memory and then select *Field Data* from the list of available data types.
6. In the *Client*, *Farm Field* or *Event* drop-down lists, select the item to delete and then tap **Delete**.
7. When prompted, tap **Yes**. The data in the internal memory is deleted.

## Deleting all of the data from the internal memory



---

**CAUTION** – Deleting data is permanent. You cannot undo the deletion or restore the data.

---

1. From the *Configuration* screen, select *System* and then tap **Setup**.
2. If necessary, enter the administration password and then tap **OK**.
3. Select *Data Files* from the list and then tap **Manage**. The *Data Files* screen appears.
4. Tap **Delete Data**. The *Delete Data Storage* screen appears.
5. Tap *Delete All Events*, or *Delete Everything*.
6. When prompted, tap **Yes**. The data in the internal memory is deleted.

## Deleting selected data from the USB memory stick



---

**CAUTION** – Deleting data is permanent. You cannot undo the deletion or restore the data.

---

1. From the *Configuration* screen, select *System* and then tap **Setup**.
2. If necessary, enter the administration password and then tap **OK**.
3. Select *Data Files* from the list and then tap **Manage**. The *Data Files* screen appears.
4. Tap **Delete Data**. The *Delete Data Storage* screen appears.
5. Select *External USB Drive* from the tabs and then select *Field Data*.
6. Select the item to delete from the *Client*, *Farm Field* or *Event* list and then tap **Delete**.
7. When prompted, tap **Yes**. The data in the internal memory is deleted.

## Deleting all of the data from the USB memory stick



---

**CAUTION** – Deleting data is permanent. You cannot undo the deletion or restore the data.

---

1. From the *Configuration* screen, select *System* and then tap **Setup**.
2. If necessary, enter the administration password and then tap **OK**.
3. Select *Data Files* from the list and then tap **Manage**. The *Data Files* screen appears.
4. Tap *Delete Data*. The *Delete Data Storage* screen appears.
5. Select *External USB Drive* from the tabs and then select the data to delete.
6. Tap either *Delete All Events* or select the data to delete.
7. When prompted, tap **Yes**. The data in the internal memory is deleted.

## Data dictionaries

The FmX integrated display can load data dictionaries in the AgGPS 170 Field Computer format. These data dictionaries enable you to select field entry data ( for example, Client, Farm, Field, and Event) from a list of predefined values, which saves you from having to re-enter commonly used items.

You can create a data dictionary either through the display, or the Farm Works software.

For more information on editing data dictionary entries on the FmX integrated display, see [Data Dictionary, page 95](#).

To create a data dictionary on an office computer:

1. On an office computer, create a text file. The text file can have any name, but the file extension **must** be .txt.
2. Enter the body text.
3. Copy the .txt file to the \AgGPS\Data Dictionary\ folder on the display's USB memory stick.

On screen ( for example, in the *Client* screen), the file entries appear as shown below:

```
[Client]
J Smith
G Wilson

[Farm]
MeadowBrook
ABC Farms

[Field]
Field 1
Field 2
Back 40
Hogan Section

[Event]
Feature mapping
Tillage
Fertilization
strip-till
Plant

[Operator]
Bob
Jim
Chris
Josh
Jose
Rob

[Material]
2, 4-D
Atrazine
35Y09
M93
NH3
```

To access the entries in the dictionary:

1. In the *Field Setup* screen, tap **New**.
2. To view the available items, tap the down arrow.
3. Select the appropriate item from the list.
4. Tap **OK**.

You can still enter new information as before, but these entries are not added to the data dictionary. To add items to the data dictionary, edit the .txt file on an office computer.



# Troubleshooting

## In this chapter:

- Advanced diagnostics
- Viewing raw serial data
- Restoring default settings
- Viewing FmX integrated display diagnostic information
- GPS Status screen
- Screen snaps
- Forcing the system to turn off

This chapter describes how to analyze problems that may occur with the FmX integrated display.

## Advanced diagnostics

the System option's Diagnostics mode enables you to configure advanced guidance settings. Most users will not need to adjust these settings.

1. From the *Configuration* screen, select System and then tap **Diagnostics**:

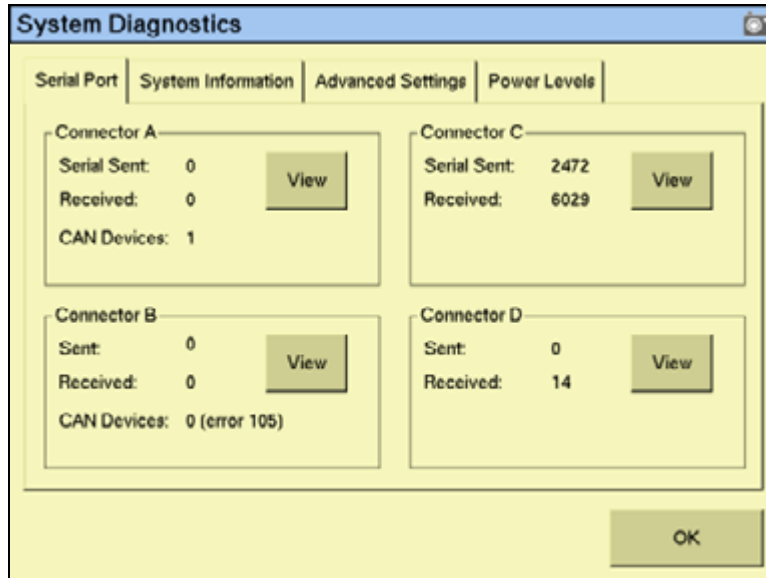

2. Tap **Advanced**:

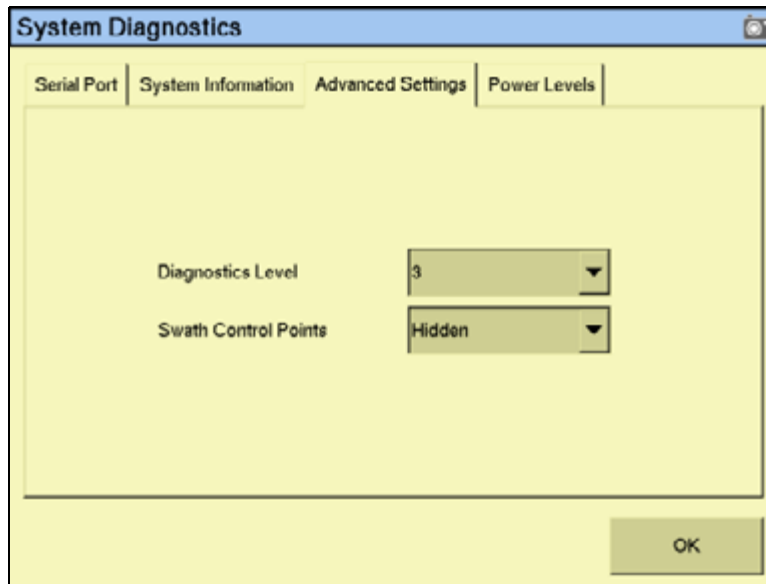



3. Select the diagnostics level. This determines how much debugging information is logged in the program files:

Item	Description
1	Minimal level of information
6 (default)	Medium level of information
9	Highest level of information

4. Select whether or not to show swath control points. When the guidance line is a curve, it appears on-screen as a series of short straight sections joined together. The Swath Control Points appear where these line segments meet:



Item	Description
Hidden (default)	Normal guidance lines
Visible	Guidance lines show the control points

You can also use the *System Diagnostics* screen to view raw port data. For more information, see [Viewing raw serial data](#), page 493.

## Viewing raw serial data

You can view raw serial data as the display receives it. This can be useful for analyzing the GPS signal.

To view the raw serial data:

1. From the *Configuration* screen, select the System option and then tap **Diagnostics**:

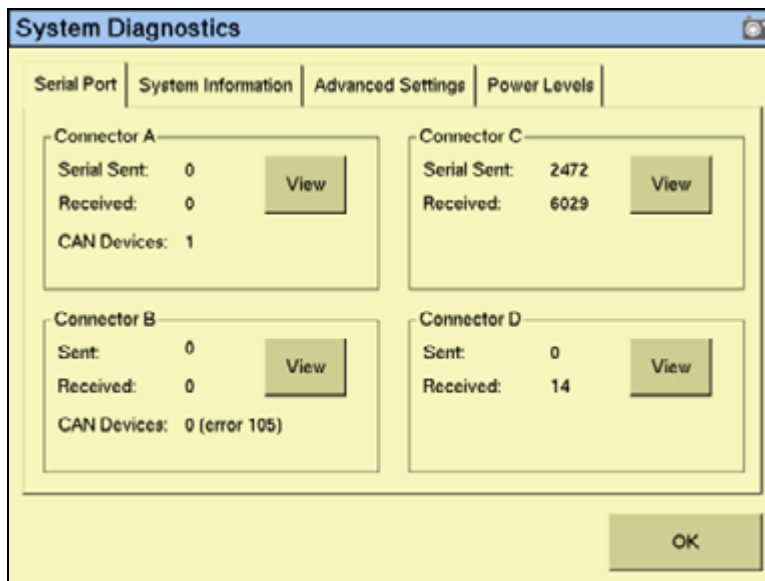

This screen shows each of the connectors (ports) on the FmX harness and the number of data packets that have been sent and received.

- To view the raw data from a port, tap the appropriate **View** button. The port diagnostics screen for that port appears:

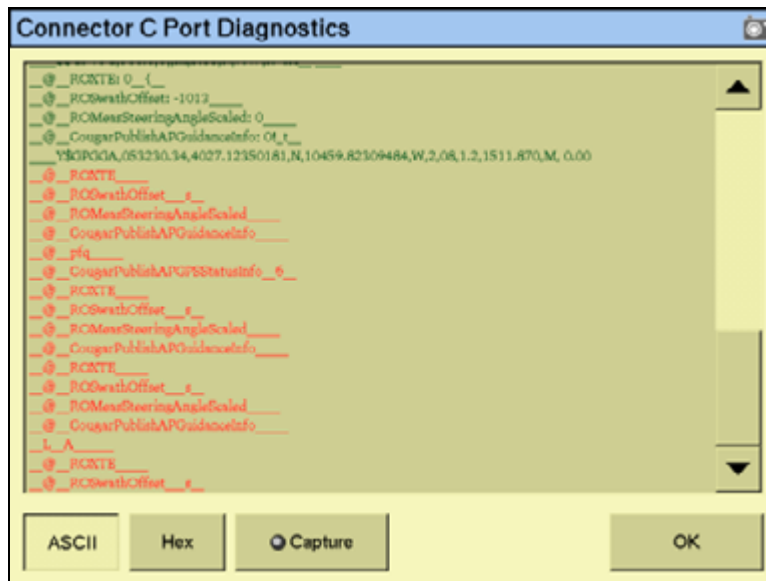

The screen shows either ASCII text or Hex code, depending on which button you select. Tap **ASCII** to view incoming data from the NMEA data string.

The Hex code is for engineering use only.

The data appears only when tap **Capture**.

A virtual LED on the *Capture* button flashes to show that data is being sent or received on that serial port.

To view the data, tap **ASCII** or **Hex** and then tap **Capture**. Approximately five seconds of serial data is captured and then appears on the screen. You can review the data or capture another snapshot.

*Note* – Data shown in green is incoming data; data shown in red is outgoing data.

## Restoring default settings

You can reset the display to its default values. This can be useful if:

- you made changes to the display settings; the results are poor, but you cannot determine which setting was the cause.
- you move the display from one vehicle to another.

*Note* – If you restore the defaults, the Autopilot vehicle setup information is not reset.

To restore the default settings:

- From the *Configuration* screen, select the System option and then tap **Setup**. The *Display Setup* screen appears.
- Tap **Default**. A confirmation screen appears.

3. Tap **Yes**.

The default settings are restored.

## Viewing FmX integrated display diagnostic information

### Display configuration information

To view display configuration information, tap  at the top right of the display.

The Home screen shows:

- Display firmware information
- Autopilot controller information
- GPS receiver and correction method information
- Vehicle make and model

### USB memory stick information

To view information about the USB memory stick that is in the display, select the System option and then tap **Diagnostics** on the *Configuration* screen.

The card information tab appears on the *System Diagnostics* screen.

### Viewing vehicle diagnostic information

From the *Configuration* screen, select the Autopilot option and then tap **Diagnostics**. The *Vehicle Controller Setup - Guidance* screen appears.

There are five parts to the Vehicle Diagnostics menu:

- Guidance screen
- Steering screen
- Details screen
- Fault log screen
- View warning screen

## Vehicle Diagnostics: Guidance screen

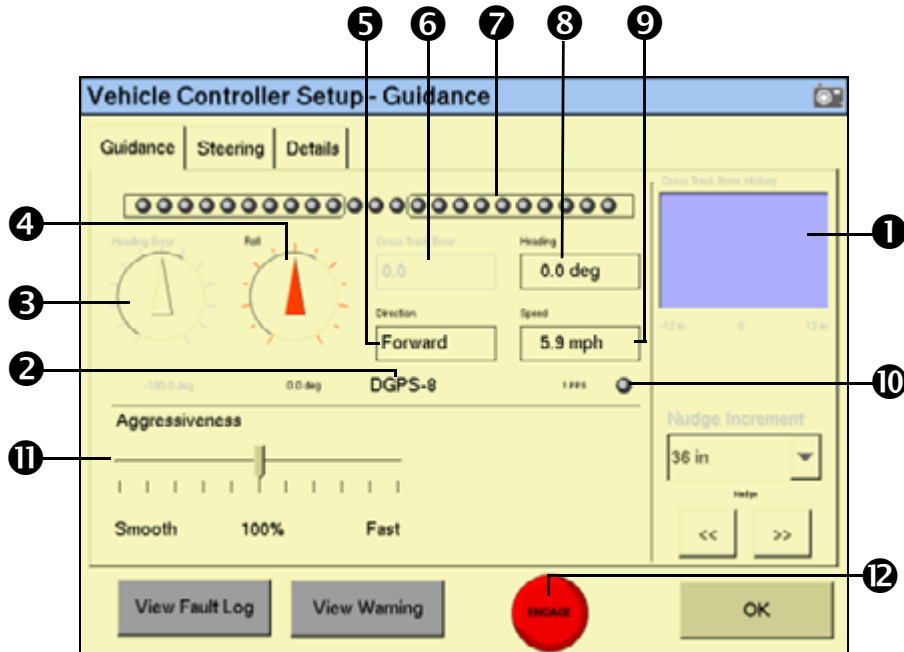

Item	Section	Description
1	Offline distance graph	A graph of offline distance over time. It is useful for diagnosing problems with the vehicle coming online and staying online.
2	GPS status	The current GPS position fix quality and number of satellites.
3	Heading error	Shows the difference between vehicle heading and path heading.
4	Roll	Shows the current roll value calculated by the system.
5	Direction	The current vehicle direction – forward, backward, or stopped.
6	Cross Track Error	A numeric value of the offline distance.
7	Virtual lightbar	Visual representation of offline distance.
8	Heading	The current vehicle heading calculated by the system.
9	Speed	The current vehicle speed calculated by the system.
10	1PPS	Shows whether the 1PPS signal from a GPS receiver is detected.
11	Aggressiveness	A slider for adjusting the Aggressiveness of the steering system.
12	Engage button	Engages/disengages the system and shows the current engage state. When this button is red, tap it to see the fault that is preventing automatic mode.

## Vehicle Diagnostics: Steering screen

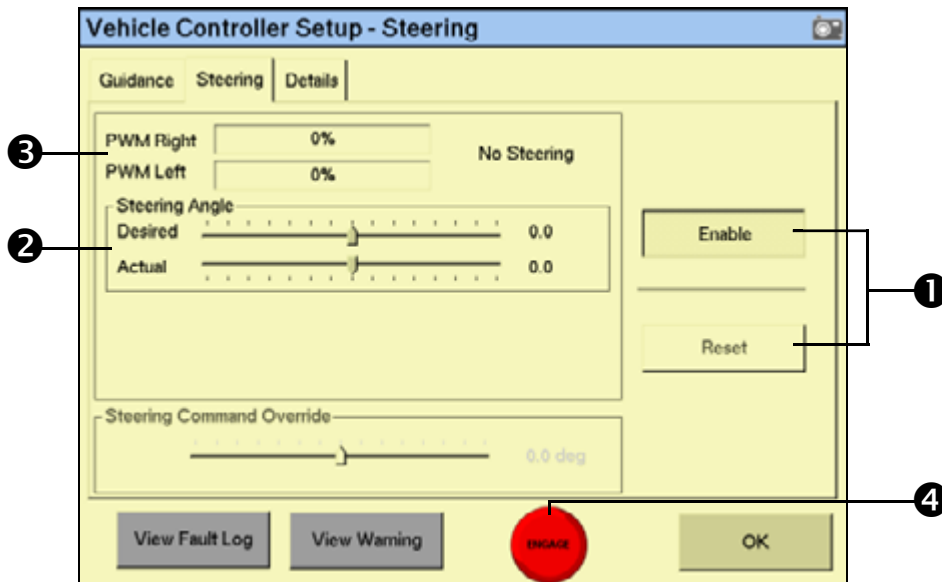

Item	Section	Description
1	Steering command override	Bypasses the normal steering command to the wheels. With this feature, you can force a certain angle of turn and make sure that the system responds as expected.
2	Steering angle	Shows the required and actual steering angles. The required angle is that which the system is trying to attain and the actual is where the system calculates the wheels are pointing.
3	PWM status	Shows the current PWM signals being sent to the electro-hydraulic valve. This is an indication of whether the system is attempting to turn left or right.
4	Engage button	Engages/Disengages the system and shows current engage status.

## Vehicle Diagnostics: Details screen

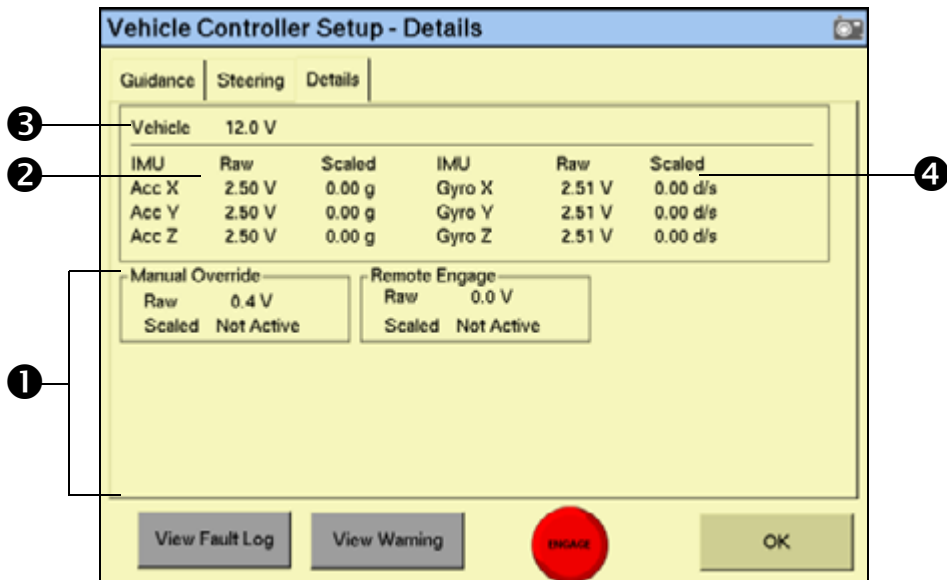

Item	Name	Description
❶	Diagnostics	Vehicle and configuration specific diagnostics - up to 9 diagnostics can be shown.
❷	Accelerometers	The raw voltage and scaled G-force for each of the system's accelerometers
❸	Vehicle voltage	The input voltage currently being fed into the Autopilot system from the vehicle's electrical system
❹	Gyroscopes	The raw voltage and scaled degrees per second of each of the system's gyroscopes

## Autopilot Faults screen

The *Autopilot Faults* screen lists all faults on the Autopilot controller:

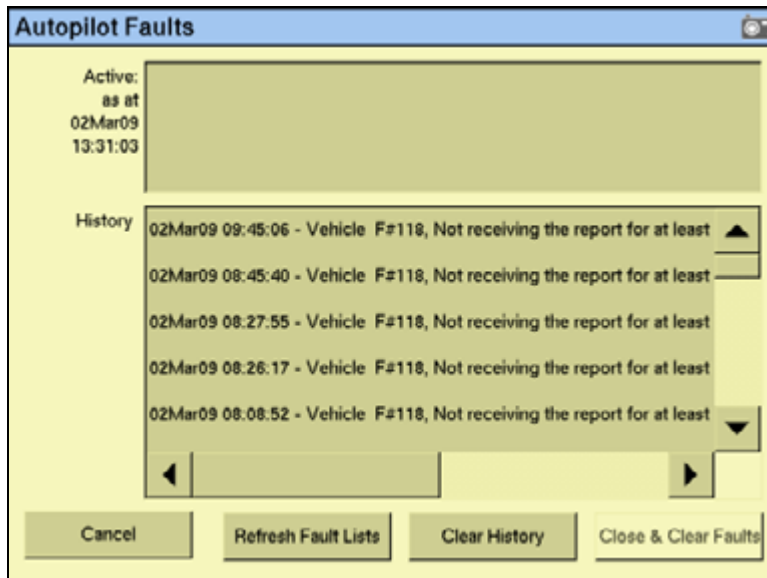

Two separate lists show:

- Any faults that are currently active
- A history of faults that have occurred

## View Warning screen

When you are viewing the vehicle diagnostics screens, the **View Warning** button flashes red if there is an active warning on the display. To view any active warnings, tap the button.

## GPS Status screen

The *GPS Status* screen provides information on the current GPS data from the GPS receiver. Use this screen to check that the GPS receiver is outputting the expected data.

- From the *Configuration* screen, select the Autopilot GPS Receiver option and then tap **Diagnostics**:

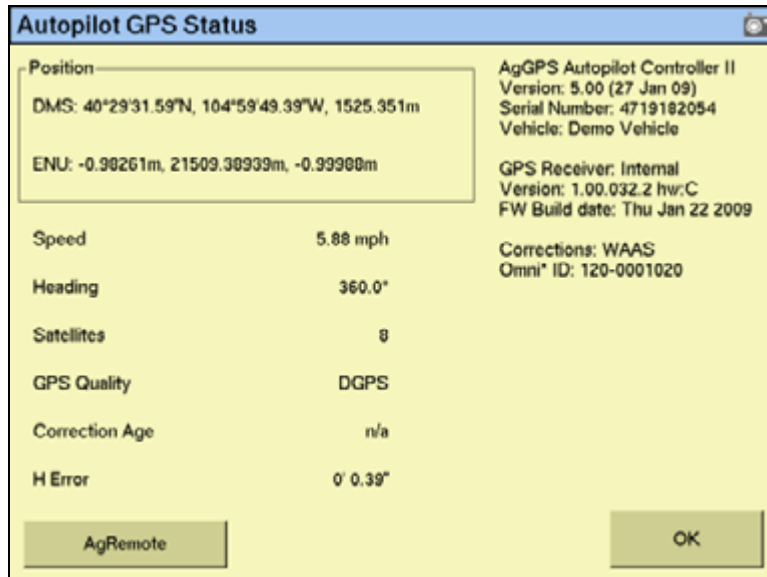



This screen shows:

- Your current GPS position
- The number of satellites
- GPS quality
- The Autopilot system and receiver version numbers

## Screen snaps

To save images in the FmX integrated display, tap the button on the right of the screen that matches the current screen.

For example, to create a screen snap of the Run screen:

- Tap . The Run screen appears.
- Tap  again. The screen snap is saved in the `\AgGPS\Diagnostics\Screenshots\` folder. A warning sound indicates that you have created a screen snap.

**Note** – The screen snap is of the lowest level folder under each button. So if you take a screen snap while in the *Implement Setup* screen, the snap is of the *Configuration* screen. The screen snap feature is most useful for capturing images of the *Run* screen.



## Forcing the system to turn off



---

**CAUTION** – Do not do this unless absolutely necessary. If the display is writing to the USB memory stick, this method of shutting down the system could corrupt the data on the card. If possible, use one of the other shutdown methods. See [Turning off the display, page 28](#).

---

If the display stops responding, hold down the Power button for 10 seconds to force the system to turn off.

