

USER GUIDE

Trimble® CFX-750™ Display

Version 7.0
Revision B
May 2015



Agriculture Business Area

Trimble Navigation Limited
Trimble Agriculture Division
10368 Westmoor Drive
Westminster, CO 80021
USA
trimble_support@trimble.com
www.trimble.com

Copyright and Trademarks

© 2015 Trimble Navigation Limited. All rights reserved.
Trimble, the Globe & Triangle logo, EZ-Boom, EZ-Pilot, EZ-Steer, Farm Works Software, T2, and Tru Count Air Clutch are trademarks of Trimble Navigation Limited, registered in the United States and in other countries.

Autopilot, AutoSense, CenterPoint, CFX-750, Connected Farm, EZ-Remote, Field-IQ, FM-750, FreeForm, LiquiBlock, RangePoint, Rawson, RTX, T3, VRS, VRS Now, and xFill are trademarks of Trimble Navigation Limited.

For STL support, the software uses the Moscow Center for SPARC Technology adaptation of the SGI Standard Template Library. Copyright © 1994 Hewlett-Packard Company, Copyright © 1996, 97 Silicon Graphics Computer Systems, Inc., Copyright © 1997 Moscow Center for SPARC Technology.

Portions Copyright © 2009 Nokia Corporation and/or its subsidiary(-ies). Portions Copyright © 2003, Bitstream Inc.

All other trademarks are the property of their respective owners.

Release Notice

This is the May 2015 release (Revision B) of the CFX-750 display documentation. It applies to version 7.0 of the display software.

Legal Notices

The following limited warranties give you specific legal rights. You may have others, which vary from state/jurisdiction to state/jurisdiction.

Product Limited Warranty

Trimble warrants that this Trimble product and its internal components (the "Product") shall be free from defects in materials and workmanship and will substantially conform to Trimble's applicable published specifications for the Product for a period of one (1) year, starting from the earlier of (i) the date of installation, or (ii) six (6) months from the date of original Product shipment from Trimble. This warranty applies only to the Product if installed by Trimble or a dealer authorized by Trimble to perform Product installation services.

Software Components

All Product software components (sometimes hereinafter also referred to as "Software") are licensed solely for use as an integral part of the Product and are not sold. Any software accompanied by a separate end user license agreement ("EULA") shall be governed by the terms, conditions, restrictions and limited warranty terms of such EULA notwithstanding the preceding paragraph.

During the limited warranty period you will be entitled to receive such Fixes to the Product software that Trimble releases and makes commercially available and for which it does not charge separately, subject to the procedures for delivery to purchasers of Trimble products generally. If you have purchased the Product from an authorized Trimble dealer rather than from Trimble directly, Trimble may, at its option, forward the software Fix to the Trimble dealer for final distribution to you. Minor Updates, Major Upgrades, new products, or substantially new software releases, as identified by Trimble, are expressly excluded from this update process and limited warranty. Receipt of software Fixes or other enhancements shall not serve to extend the limited warranty period.

For purposes of this warranty the following definitions shall apply: (1) "Fix(es)" means an error correction or other update created to fix a previous software version that does not substantially conform to its Trimble specifications; (2) "Minor Update" occurs when enhancements are made to current features in a software program; and (3) "Major Upgrade" occurs when significant new features are added to software, or when a new product containing new features replaces the further development of a current product line. Trimble reserves the right to determine, in its sole discretion, what constitutes a Fix, Minor Update, or Major Upgrade.

This Trimble software contains Qt 4.5 libraries licensed under the GNU Lesser General Public License (LGPL). The source is available from

<http://qt.nokia.com/downloads>. A copy of the LGPL license is included in the appendices of this manual, and at ftp://ftp.trimble.com/pub/open_source/FmX. This software includes the DejaVu fonts, which are licensed under the Bitstream Vera license, terms available at <http://dejavufonts.org/wiki/index.php?title=License> and <http://www.gnome.org/fonts/>.

GNU LESSER GENERAL PUBLIC LICENSE

Version 2.1, February 1999

Copyright © 1991, 1999 Free Software Foundation, Inc.
51 Franklin Street, Fifth Floor, Boston, MA 02110-1301
USA

Everyone is permitted to copy and distribute verbatim copies of this license document, but changing it is not allowed. [This is the first released version of the Lesser GPL. It also counts as the successor of the GNU Library Public License, version 2, hence the version number 2.1.]

Preamble

The licenses for most software are designed to take away your freedom to share and change it. By contrast, the GNU General Public Licenses are intended to guarantee your freedom to share and change free software to make sure the software is free for all its users.

This license, the Lesser General Public License, applies to some specially designated software packages—typically libraries—of the Free Software Foundation and other authors who decide to use it. You can use it too, but we suggest you first think carefully about whether this license or the ordinary General Public License is the better strategy to use in any particular case, based on the explanations below.

When we speak of free software, we are referring to freedom of use, not price. Our General Public Licenses are designed to make sure that you have the freedom to distribute copies of free software (and charge for this service if you wish); that you receive source code or can get it if you want it; that you can change the software and use pieces of it in new free programs; and that you are informed that you can do these things. To protect your rights, we need to make restrictions that forbid distributors to deny you these rights or to ask you to surrender these rights. These restrictions translate to certain responsibilities for you if you distribute copies of the library or if you modify it.

For example, if you distribute copies of the library, whether gratis or for a fee, you must give the recipients all the rights that we gave you. You must make sure that they, too, receive or can get the source code. If you link other code with the library, you must provide complete object files to the recipients, so that they can relink them with the library after making changes to the library and recompiling it. And you must show them these terms so they know their rights.

We protect your rights with a two-step method: (1) we copyright the library, and (2) we offer you this license, which gives you legal permission to copy, distribute and/or modify the library.

To protect each distributor, we want to make it very clear that there is no warranty for the free library. Also, if the library is modified by someone else and passed on, the recipients should know that what they have is not the original version, so that the original author's reputation will not be affected by problems that might be introduced by others.

Finally, software patents pose a constant threat to the existence of any free program. We wish to make sure that a company cannot effectively restrict the users of a free program by obtaining a restrictive license from a patent holder. Therefore, we insist that any patent license obtained for a version of the library must be consistent with the full freedom of use specified in this license.

Most GNU software, including some libraries, is covered by the ordinary GNU General Public License. This license, the GNU Lesser General Public License, applies to certain designated libraries, and is quite different from the ordinary General Public License. We use this license for certain libraries in order to permit linking those libraries into non-free programs. When a program is linked with a library, whether statically or using a shared library, the combination of the two is legally speaking a combined work, a derivative of the original library. The ordinary General Public License therefore permits such linking only if the entire combination fits its criteria of freedom. The Lesser General Public License permits more lax criteria for linking other code with the library.

We call this license the "Lesser" General Public License because it does less to protect the user's freedom than the ordinary General Public License. It also provides other free software developers less of an advantage over competing non-free programs. These disadvantages are the reason we use the ordinary General Public License for many libraries. However, the Lesser license provides advantages in certain special circumstances.

For example, on rare occasions, there may be a special need to encourage the widest possible use of a certain library, so that it becomes a de-facto standard. To achieve this, non-free programs must be allowed to use the library. A more frequent case is that a free library does the same job as widely used non-free libraries. In this case, there is little to gain by limiting the free library to free software only, so we use the Lesser General Public License.

In other cases, permission to use a particular library in nonfree programs enables a greater number of people to use a large body of free software. For example, permission to use the GNU C Library in non-free programs enables many more people to use the whole GNU operating system, as well as its variant, the GNU/Linux operating system.

Although the Lesser General Public License is less protective of the users' freedom, it does ensure that the user of a program that is linked with the Library has the freedom and the wherewithal to run that program using a modified version of the Library.

The precise terms and conditions for copying, distribution and modification follow. Pay close attention to the difference between a "work based on the library" and a "work that uses the library". The former contains code derived from the library, whereas the latter must be combined with the library in order to run.

GNU LESSER GENERAL PUBLIC LICENSE TERMS AND CONDITIONS FOR COPYING, DISTRIBUTION AND MODIFICATION

0. This License Agreement applies to any software library or other program which contains a notice placed by the copyright holder or other authorized party saying it may be distributed under the terms of this Lesser General Public License (also called "this License"). Each licensee is addressed as "you".

A "library" means a collection of software functions and/or data prepared so as to be conveniently linked with application programs (which use some of those functions and data) to form executables.

The "Library", below, refers to any such software library or work which has been distributed under these terms. A "work based on the Library" means either the Library or any derivative work under copyright law: that is to say, a work containing the Library or a portion of it, either verbatim or with modifications and/or translated straightforwardly into another language. (Hereinafter, translation is included without limitation in the term "modification".)

"Source code" for a work means the preferred form of the work for making modifications to it. For a library, complete source code means all the source code for all modules it contains, plus any associated interfacedefinition files, plus the scripts used to control compilation and installation of the library.

Activities other than copying, distribution and modification are not covered by this License; they are outside its scope. The act of running a program using the Library is not restricted, and output from such a program is covered only if its contents constitute a work based on the Library (independent of the use of the Library in a tool for writing it). Whether that is true depends on what the Library does and what the program that uses the Library does.

1. You may copy and distribute verbatim copies of the Library's complete source code as you receive it, in any medium, provided that you conspicuously and appropriately publish on each copy an appropriate copyright notice and disclaimer of warranty; keep intact all the notices that refer to this License and to the absence of any warranty; and distribute a copy of this License along with the Library.

You may charge a fee for the physical act of transferring a copy, and you may at your option offer warranty protection in exchange for a fee.

2. You may modify your copy or copies of the Library or any portion of it, thus forming a work based on the Library, and copy and distribute such modifications or work under the terms of Section 1 above, provided that you also meet all of these conditions:

- The modified work must itself be a software library.
- You must cause the files modified to carry prominent notices stating that you changed the files and the date of any change.
- You must cause the whole of the work to be licensed at no charge to all third parties under the terms of this License.
- If a facility in the modified Library refers to a function or a table of data to be supplied by an application program that uses the facility, other than as an argument passed when the facility is invoked, then you must make a good faith effort to ensure that, in the event an application does not supply such function or table, the facility still operates, and performs whatever part of its purpose remains meaningful. (For example, a function in a library to compute square roots has a purpose that is entirely well-defined independent of the application.

Therefore, Subsection 2d requires that any application-supplied function or table used by this function must be optional: if the application does not supply it, the square root function must still compute square roots.)

These requirements apply to the modified work as a whole. If identifiable sections of that work are not derived from the Library, and can be reasonably considered independent and separate works in themselves, then this License, and its terms, do not apply to those sections when you distribute them as separate works. But when you distribute the same sections as part of a whole which is a work based on the Library, the distribution of the whole must be on the terms of this License, whose permissions for other licensees extend to the entire whole, and thus to each and every part regardless of who wrote it. Thus, it is not the intent of this section to claim rights or contest your rights to work written entirely by you; rather, the intent is to exercise the right to control the distribution of derivative or collective works based on the Library.

In addition, mere aggregation of another work not based on the Library with the Library (or with a work based on the Library) on a volume of a storage or distribution medium does not bring the other work under the scope of this License.

3. You may opt to apply the terms of the ordinary GNU General Public License instead of this License to a given copy of the Library. To do this, you must alter all the notices that refer to this License, so that they refer to the ordinary GNU General Public License, version 2, instead of to this License. (If a newer version than version 2 of the ordinary GNU General Public License has appeared, then you can specify that version instead if you wish.)

Do not make any other change in these notices. Once this change is made in a given copy, it is irreversible for that copy, so the ordinary GNU General Public License applies to all subsequent copies and derivative works made from that copy. This option is useful when you wish to copy part of the code of the Library into a program that is not a library.

4. You may copy and distribute the Library (or a portion or derivative of it, under Section 2) in object code or executable form under the terms of Sections 1 and 2 above provided that you accompany it with the complete corresponding machine-readable source code, which must be distributed under the terms of Sections 1 and 2 above on a medium customarily used for software interchange.

If distribution of object code is made by offering access to copy from a designated place, then offering equivalent access to copy the source code from the same place satisfies the requirement to distribute the source code, even though third parties are not compelled to copy the source along with the object code.

5. A program that contains no derivative of any portion of the Library, but is designed to work with the Library by being compiled or linked with it, is called a "work that uses the Library". Such a work, in isolation, is not a derivative work of the Library, and therefore falls outside the scope of this License.

However, linking a "work that uses the Library" with the Library creates an executable that is a derivative of the Library (because it contains portions of the Library), rather than a "work that uses the library". The executable is therefore covered by this License.

Section 6 states terms for distribution of such executables. When a "work that uses the Library" uses material from a header file that is part of the Library, the object code for the work may be a derivative work of the Library even though the source code is not. Whether this is true is especially significant if the work can be linked without the Library, or if the work is itself a library. The threshold for this to be true is not precisely defined by law.

If such an object file uses only numerical parameters, data structure layouts and accessors, and small macros and small inline functions (ten lines or less in length), then the use of the object file is unrestricted, regardless of whether it is legally a derivative work. (Executables containing this object code plus portions of the Library will still fall under Section 6.)

Otherwise, if the work is a derivative of the Library, you may distribute the object code for the work under the terms of Section 6. Any executables containing that work also fall under Section 6, whether or not they are linked directly with the Library itself.

6. As an exception to the Sections above, you may also combine or link a "work that uses the Library" with the Library to produce a work containing portions of the Library, and distribute that work under terms of your choice, provided that the terms permit modification of the work for the customer's own use and reverse engineering for debugging such modifications.

You must give prominent notice with each copy of the work that the Library is used in it and that the Library and its use are covered by this License. You must supply a copy of this License. If the work during

execution displays copyright notices, you must include the copyright notice for the Library among them, as well as a reference directing the user to the copy of this License. Also, you must do one of these things:

a) Accompany the work with the complete corresponding machine-readable source code for the Library including whatever changes were used in the work (which must be distributed under Sections 1 and 2 above); and, if the work is an executable linked with the Library, with the complete machine-readable "work that uses the Library", as object code and/or source code, so that the user can modify the Library and then relink to produce a modified executable containing the modified Library. (It is understood that the user who changes the contents of definitions files in the Library will not necessarily be able to recompile the application to use the modified definitions.)

b) Use a suitable shared library mechanism for linking with the Library. A suitable mechanism is one that (1) uses at run time a copy of the library already present on the user's computer system, rather than copying library functions into the executable, and (2) will operate properly with a modified version of the library, if the user installs one, as long as the modified version is interface-compatible with the version that the work was made with.

c) Accompany the work with a written offer, valid for at least three years, to give the same user the materials specified in Subsection 6a, above, for a charge no more than the cost of performing this distribution.

d) If distribution of the work is made by offering access to copy from a designated place, offer equivalent access to copy the above specified materials from the same place.

e) Verify that the user has already received a copy of these materials or that you have already sent this user a copy.

For an executable, the required form of the "work that uses the Library" must include any data and utility programs needed for reproducing the executable from it. However, as a special exception, the materials to be distributed need not include anything that is normally distributed (in either source or binary form) with the major components (compiler, kernel, and so on) of the operating system on which the executable runs, unless that component itself accompanies the executable.

It may happen that this requirement contradicts the license restrictions of other proprietary libraries that do not normally accompany the operating system. Such a contradiction means you cannot use both them and the Library together in an executable that you distribute.

7. You may place library facilities that are a work based on the Library side-by-side in a single library together with other library facilities not covered by this License, and distribute such a combined library, provided that the separate distribution of the work based on the Library and of the other library facilities is otherwise permitted, and provided that you do these two things:

a) Accompany the combined library with a copy of the same work based on the Library, uncombined with any other library facilities. This must be distributed under the terms of the Sections above.

b) Give prominent notice with the combined library of the fact that part of it is a work based on the Library, and explaining where to find the accompanying uncombined form of the same work.

8. You may not copy, modify, sublicense, link with, or distribute the Library except as expressly provided under this License. Any attempt otherwise to copy, modify, sublicense, link with, or distribute the Library is void, and will automatically terminate your rights under this License. However, parties who have received copies, or rights, from you under this License will not have their licenses terminated so long as such parties remain in full compliance.

9. You are not required to accept this License, since you have not signed it. However, nothing else grants you permission to modify or distribute the Library or its derivative works. These actions are prohibited by law if you do not accept this License. Therefore, by modifying or distributing the Library (or any work based on the Library), you indicate your acceptance of this License to do so, and all its terms and conditions for copying, distributing or modifying the Library or works based on it.

10. Each time you redistribute the Library (or any work based on the Library), the recipient automatically receives a license from the original licensor to copy, distribute, link with or modify the Library subject to these terms and conditions. You may not impose any further restrictions on the recipients' exercise of the rights granted herein. You are not responsible for enforcing compliance by third parties with this License.

Warranty Remedies

Trimble's sole liability and your exclusive remedy under the warranties set forth above shall be, at Trimble's option, to repair or replace any Product that fails to conform to such warranty ("Nonconforming Product"), and/or issue a cash refund up to the purchase price paid by you for any such Nonconforming Product, excluding costs of installation,

upon your return of the Nonconforming Product to Trimble in accordance with Trimble's product return procedures then in effect. Such remedy may include reimbursement of the cost of repairs for damage to third-party equipment onto which the Product is installed, if such damage is found to be directly caused by the Product as reasonably determined by Trimble following a root cause analysis.

Warranty Exclusions and Disclaimer

These warranties shall be applied only in the event and to the extent that (a) the Products and Software are properly and correctly installed, configured, interfaced, maintained, stored, and operated in accordance with Trimble's relevant operator's manual and specifications, and; (b) the Products and Software are not modified or misused. The preceding warranties shall not apply to, and Trimble shall not be responsible for defects or performance problems resulting from (i) the combination or utilization of the Product or Software with hardware or software products, information, data, systems, interfaces or devices not made, supplied or specified by Trimble; (ii) the operation of the Product or Software under any specification other than, or in addition to, Trimble's standard specifications for its products; (iii) the unauthorized, installation, modification, or use of the Product or Software; (iv) damage caused by accident, lightning or other electrical discharge, fresh or salt water immersion or spray (outside of Product specifications); or (v) normal wear and tear on consumable parts (e.g., batteries). Trimble does not warrant or guarantee the results obtained through the use of the Product or that software components will operate error free.

THE WARRANTIES ABOVE STATE TRIMBLE'S ENTIRE LIABILITY, AND YOUR EXCLUSIVE REMEDIES, RELATING TO THE PRODUCTS AND SOFTWARE. EXCEPT AS OTHERWISE EXPRESSLY PROVIDED HEREIN, THE PRODUCTS, SOFTWARE, AND ACCOMPANYING DOCUMENTATION AND MATERIALS ARE PROVIDED "AS IS" AND WITHOUT EXPRESS OR IMPLIED WARRANTY OF ANY KIND BY EITHER TRIMBLE NAVIGATION LIMITED OR ANYONE WHO HAS BEEN INVOLVED IN ITS CREATION, PRODUCTION, INSTALLATION, OR DISTRIBUTION INCLUDING, BUT NOT LIMITED TO, THE IMPLIED WARRANTIES OF MERCHANTABILITY AND FITNESS FOR A PARTICULAR PURPOSE, TITLE, AND NONINFRINGEMENT. THE STATED EXPRESS WARRANTIES ARE IN LIEU OF ALL OBLIGATIONS OR LIABILITIES ON THE PART OF TRIMBLE ARISING OUT OF, OR IN CONNECTION WITH, ANY PRODUCTS OR SOFTWARE. BECAUSE SOME STATES AND JURISDICTIONS DO NOT ALLOW LIMITATIONS ON DURATION OR THE EXCLUSION OF AN IMPLIED WARRANTY, THE ABOVE LIMITATION MAY NOT APPLY OR FULLY APPLY TO YOU.

NOTICE REGARDING PRODUCTS EQUIPPED WITH TECHNOLOGY CAPABLE OF TRACKING SATELLITE SIGNALS FROM SATELLITE BASED AUGMENTATION SYSTEMS (SBAS) (WAAS/EGNOS, AND MSAS), OMNISTAR, GNSS, MODERNIZED GNSS OR GLONASS SATELLITES, OR FROM IALA BEACON SOURCES: TRIMBLE IS NOT RESPONSIBLE FOR THE OPERATION OR FAILURE OF OPERATION OF ANY SATELLITE BASED POSITIONING SYSTEM OR THE AVAILABILITY OF ANY SATELLITE BASED POSITIONING SIGNALS.

Limitation or Liability

TRIMBLE'S ENTIRE LIABILITY UNDER ANY PROVISION HEREIN SHALL BE LIMITED TO THE AMOUNT PAID BY YOU FOR THE PRODUCT OR SOFTWARE LICENSE. TO THE MAXIMUM EXTENT PERMITTED BY APPLICABLE LAW, IN NO EVENT SHALL TRIMBLE OR ITS SUPPLIERS BE LIABLE FOR ANY INDIRECT, SPECIAL, INCIDENTAL OR CONSEQUENTIAL DAMAGES WHATSOEVER UNDER ANY CIRCUMSTANCE OR LEGAL THEORY RELATING IN ANY WAY TO THE PRODUCTS, SOFTWARE AND ACCOMPANYING DOCUMENTATION AND MATERIALS, (INCLUDING, WITHOUT LIMITATION, DAMAGES FOR LOSS OF BUSINESS PROFITS, BUSINESS INTERRUPTION, LOSS OF BUSINESS INFORMATION, OR ANY OTHER PECUNIARY LOSS), REGARDLESS WHETHER TRIMBLE HAS BEEN ADVISED OF THE POSSIBILITY OF ANY SUCH LOSS AND REGARDLESS OF THE COURSE OF DEALING WHICH DEVELOPS OR HAS DEVELOPED BETWEEN YOU AND TRIMBLE. BECAUSE SOME STATES AND JURISDICTIONS DO NOT ALLOW THE EXCLUSION OR LIMITATION OF LIABILITY FOR CONSEQUENTIAL OR INCIDENTAL DAMAGES, THE ABOVE LIMITATION MAY NOT APPLY OR FULLY APPLY TO YOU.

PLEASE NOTE: THE ABOVE TRIMBLE LIMITED WARRANTY PROVISIONS WILL NOT APPLY TO PRODUCTS PURCHASED IN THOSE JURISDICTIONS (E.G., MEMBER STATES OF THE EUROPEAN ECONOMIC AREA) IN WHICH PRODUCT WARRANTIES ARE THE RESPONSIBILITY OF THE LOCAL DEALER FROM WHOM THE PRODUCTS ARE ACQUIRED. IN SUCH A

CASE, PLEASE CONTACT YOUR TRIMBLE DEALER FOR APPLICABLE WARRANTY INFORMATION.

Official Language

THE OFFICIAL LANGUAGE OF THESE TERMS AND CONDITIONS IS ENGLISH. IN THE EVENT OF A CONFLICT BETWEEN ENGLISH AND OTHER LANGUAGE VERSIONS, THE ENGLISH LANGUAGE SHALL CONTROL.

Registration

To receive information regarding updates and new products, please contact your local dealer or visit the Trimble website at www.trimble.com/register. Upon registration you may select the newsletter, upgrade or new product information you desire.

Notices

This equipment has been tested and found to comply with the limits for a Class A digital device, pursuant to Part 15 of the FCC rules. These limits are designed to provide reasonable protection against harmful interference when the equipment is operated in a commercial environment. This equipment generates, uses, and can radiate radio frequency energy and, if not installed and used in accordance with the instruction manual, may cause harmful interference to radio communications. Operation of this equipment in a residential area is likely to cause harmful interference, in which case the user will be required to correct the interference at his own expense. Properly shielded and grounded cables and connectors must be used in order to meet FCC emission limits. TRIMBLE is not responsible for any radio or television interference caused by using other than recommended cables and connectors or by unauthorized changes or modifications to this equipment. Unauthorized changes or modifications could void the user's authority to operate the equipment. This device complies with Part 15 of the FCC rules. Operation is subject to the following two conditions: (1) this device may not cause harmful interference, and (2) this device must accept any interference received, including interference that may cause undesired operation.

Responsible Party:
Trimble Navigation
935 Stewart Drive
Sunnyvale CA 94085
Telephone: 1-408 481 8000

Canada

This Class A digital apparatus complies with Canadian ICES-003. Cet appareil numérique de la classe A est conforme à la norme NMB-003 du Canada.
This apparatus complies with Canadian RSS-GEN. Cet appareil est conforme à la norme CNR-GEN du Canada.

Europe

This product has been tested and found to comply with the requirements for a Class A device pursuant to European Council Directive 2006/42/EC and 1999/5/EC, thereby satisfying the requirements for CE Marking and sale within the European Economic Area (EEA). Contains a radio module. These requirements are designed to provide reasonable protection against harmful interference when the equipment is operated in a residential or commercial environment.

Australia and New Zealand

This product conforms with the regulatory requirements of the Australian Communications and Media Authority (ACMA) EMC framework, thus satisfying the requirements for C-Tick Marking and sale within Australia and New Zealand.

Notice to Our European Union Customers

For product recycling instructions and more information, please go to http://www.trimble.com/Corporate/Environmental_Combpliance.aspx.

Recycling in Europe: To recycle Trimble WEEE (Waste Electrical and Electronic Equipment, products that run on electrical power.), Call +31 497 53 24 30, and ask for the "WEEE Associate". Or, mail a request for recycling instructions to:
Trimble Europe BV
c/o Menlo Worldwide Logistics
Meerheide 45
5521 DZ Eersel, NL

Contents

Safety Information	17
Warnings	17
Auto guidance	17
Calibration	17
NH ₃ , anhydrous ammonia	18
Cautions	18
Calibration	18
Display	18
EZ-Pilot system	18
GNSS	19
Prescriptions	19
Installation	19
USB socket	19
Working with anhydrous ammonia	19
Servicing the Equipment	20
Discharging the System	20
1 Introduction	21
About the CFX-750 display	22
Changes to this document	22
Related information	22
Technical assistance	23
2 Installation	25
System components	26
Install the CFX-750 display	27
Install the display mount	27
Attach the display to the mount	28
Connect the CFX-750 display	29
For WAAS/EGNOS/OmniSTAR® XP/HP corrections	29
For RTK corrections	30
Install and connect the antenna	31
Install external foot/rocker switch	32
3 Getting started	35
Display basics	36
Display hardware	36
Front view of display	36
Back view of display	37
Power up	38
Power down	39
Quick start wizard	39

USB socket	39
Reset the display	39
Soft reset	39
Hard reset	40
Take a screen shot	41
Clean the touchscreen	42
On-screen basics	43
Touchscreen basics	43
Buttons	43
Icons indicating status	43
Entering information	44
Wizards	45
On-screen help	45
Guidance screen	45
Buttons on Guidance screen	46
Settings screen	50
Buttons on the Settings screen	51
Navigation controls	52
Icons on buttons	52
Information icons	53
4 Vehicle guidance setup	55
EZ-Steer steering system	56
EZ-Steer system setup	56
Engage Options	56
Vehicle Setup	57
Aggressiveness	58
Advanced	58
EZ-Steer Demo	59
EZ-Steer system calibration	59
Vehicle measurements	59
T2 roll calibration	61
EZ-Steer system calibration	61
EZ-Pilot steering system	62
EZ-Pilot system setup	62
Engage Options	62
Vehicle Setup	63
Aggressiveness	64
Advanced	64
EZ-Pilot Demo	64
EZ-Pilot system calibration	64
Vehicle measurements	65
T3 terrain compensation calibration	67
Angle Per Turn calibration	67

EZ-Pilot system calibration	67
Autopilot steering system	68
Autopilot system setup	68
Load VDB	70
Manual Override	70
Controller Orientation	71
Line Acquisition	72
Steering Sensor calibration	73
Pre-calibration	73
Calibration procedure	73
Autopilot Automated Deadzone Calibration	74
Pre-calibration	75
Calibration procedure	75
Autopilot Steering Gain calibration	76
Pre-calibration	77
Calibration	77
Roll / Antenna Compensation	78
Antenna Height	78
Antenna-to-Axle Offset	78
Roll Compensation	79
Pre-calibration	79
Calibration procedure	79
Performance Settings	81
Advanced settings for the Autopilot system	81
Autopilot Operation	82
Autopilot Steering Sensor	82
Status/Diagnostics for the Autopilot system	82
Cross Track Error (for advanced users)	83
Evaluate vehicle response	84
Save or restore vehicle configuration file	84
Foot or rocker switch setup	85
EZ-Remote Joystick custom settings	86
Keypad Assignment Wizard	87
Joystick buttons	88
LED Brightness	89
Keypad Assignments	89
5 Implement application controller setup	91
Implement application controller setup	92
Prescriptions	93
Load a prescription	93
HARDI 5500 / 6500 controller setup	94
Advanced	94
Boom Setup	94

Swath Control	95
Rate control	95
Off When Stopped	95
Rate Snapping	96
Raven controller setup	97
Advanced	98
Boom Setup	98
Target Rate	98
Rate Snapping	98
Rawson controller setup	99
Advanced	99
Boom Setup	100
Swath Control	100
Target Rate	100
Default Rate	101
Step Size	101
Rate Snapping	101
Amazone controller setup	102
Advanced	102
Boom Setup	102
Swath Control	103
Rate control	103
Target Rate	103
Turn Off Rate on Overlap	104
Rate Snapping	104
LH 5000 controller setup	105
Advanced	105
Boom Setup	105
Swath Control	105
Rate control	106
Target Rate	106
Turn Off Rate on Overlap	106
Rate Snapping	107
Vaderstad controller setup	108
Advanced	108
Boom Setup	108
Swath Control	109
Rate control	109
Target Rate	109
Single section boom switching	109
Rate Snapping	110
Bogballe controller setup	111
Advanced	111
Boom Setup	111

Swath Control	112
Rate control	112
Target Rate	112
Single section boom switching	112
Check communication status	113
6 Field-IQ crop input control setup	115
Overview of Field-IQ	116
Definitions	117
Units of measure	117
Field-IQ crop input installation	118
Field-IQ setup for implements	119
Implement and controller type	119
Operation and layout setup	119
Implement measurements	120
Implement switches	122
Material setup	123
Row Crop Seed setup	124
Control setup for a location	127
Material assignment	128
Material control	128
Section Control setup	130
Rate Control Setup	133
Row Monitoring Setup	136
Sensor Setup	138
System Status	139
Hydraulics Test	139
Calibrations	140
7 Boom Height Control setup	141
Boom Height Control hardware installation	142
Field-IQ Boom Height Control setup	142
Boom Height Control calibration	144
8 Mapping guidance setup	145
Guidance and mapping	146
Guidance settings	146
Turn Settings	146
Minimum turn radius mode	146
Tight turn alert threshold	147
Auto U-turn detection	147
Coverage Settings	147
Coverage on/off delay	147

Coverage logging	147
Nudge settings	148
Mapping	148
Warning distance	148
Recording position	148
Delete features	149
FreeForm Recording	149
Headland/Infill Switching	149
Boundary setup	150
Boundaries	150
Expand Boundaries	150
Implement setup for guidance	151
Curve smoothing settings	153
9 Yield Monitoring setup	155
Yield Monitoring setup	156
Yield Monitoring calibration	158
Calibrations before entering the field	158
Header Height Calibration	158
Tare Calibration	159
Temperature Calibration	159
Roll Calibration	160
Calibrations in the field	160
Yield flow and moisture sensor calibration	160
Speed method	160
Cut width method	161
Calibration instructions	162
Yield Monitor status	163
System status	163
Optical sensor status	163
10 GNSS setup	165
GNSS setup	166
Frequency and baud rate	167
xFill technology	168
Correction services setup	168
CenterPoint RTX	168
Example	170
Renew CenterPoint RTX subscription	170
RangePoint RTX	170
Example	171
Renew RangePoint RTX subscription	171
VRS	171

Position quality	173
GNSS advanced settings	173
GNSS status	174
GNSS Status	174
Satellite Status	174
DGPS Status	175
11 Data	177
Data management	178
Data transfer	178
Transfer data wirelessly	178
DCM-300 modem setup	179
Passcodes	179
Unlock DCM-300 modem	179
Office Sync setup	180
Requirements	180
Office Sync and Initial Setup	181
Device name	181
Server Address	181
Modem only setup	182
Manual wireless transfer with Office Sync	182
USB drive data transfer	183
USB drive compatibility	183
Insert a USB drive	184
Remove a USB drive	184
Retrieve or send data using the USB drive	185
Clear display's internal memory	185
12 System settings	187
System settings	188
Quick start wizard	188
Display settings	189
Units	189
Color Scheme	189
Time Zone	189
View	190
Status Popup Transparency	190
Backlight	190
Alert Beeper	191
Touchscreen beeper volume	191
Lightbar Setup	191
Advanced display settings	192
Save/Load Configurations	192

Digital Output	192
Advanced User Config	193
NMEA Output	194
Unlock / Upgrade	195
Unlock features using screens	195
Unlock features using USB drive	196
Upgrade your display's firmware	196
Status	196
About the display	198
Restore defaults	198
Recalibrate touchscreen	198
13 Operations	201
Map guidance and features	202
Distance between guidance lines	202
Headlands	202
On-screen appearance	202
Guidance line / pattern mapping	203
Straight AB	204
Map an AB line	204
A+ line	205
Map an A+ line	205
Identical curve	205
Map an identical curve	206
Adaptive curve	206
Map an adaptive curve	206
Change the Auto U-turn detection setting	207
Map an adaptive curve with automatic turn detection	207
Map an adaptive curve manually	207
Use the adaptive curve pattern for row-finding	207
Create straight sections on curve swaths	207
Pivot	208
Map a pivot	208
Headland	208
Number of circuits	209
Internal pattern	209
Re-select the headland	209
Map a headland	210
Create straight sections on Headland swaths	210
FreeForm	211
Record a FreeForm curve	211
Use the FreeForm pattern to define a straight AB line	212
Switch to another line	212
Use FreeForm curves in spiral fields	212

Use FreeForm curves in fields with variable terrain	212
Use guidance on curved segments	212
Pause / Resume guidance	213
Resetting guidance	213
Guidance mapping buttons	214
Feature mapping buttons	215
Line Feature	215
Fields	217
New field creation	217
Add an AB line to a current field	217
Load an AB line into a field	217
Record keeping	218
Auto steering system operation	219
EZ-Steer system operation	219
Engage the system	219
Disengage automatically	219
Disengage manually	219
Engage on-screen control	220
Changing from forward to reverse	220
Adjust aggressiveness	220
Curve Auto steering Accuracy in Headlands	221
Vehicle-specific performance suggestions	221
After using the EZ-Steer system	222
EZ-Pilot system operation	222
Engage the system	222
Disengage automatically	223
Disengage manually	223
Engage on-screen control	223
Changing from forward to reverse	224
After using the EZ-Pilot system	224
Autopilot system operation	224
Engage the system	225
Disengage automatically	225
Disengage manually	225
Engage on-screen control	226
Adjust aggressiveness	226
After using the Autopilot steering system	226
EZ-Remote joystick use	227
Lightbar patterns	228
Field-IQ operation	230
Quick access button for Field-IQ	232
Boom setup	232
Refill	232
Section switching setup	233

Boundary switching overlap	233
On/off valve latency	234
Intentional overlap	234
Target rate	234
Valve aggressiveness	234
Field-IQ master switch box	235
Field-IQ 12-section switch box	236
Automatic/Manual section switch	236
LED status lights	237
Operate implement controllers	238
Amazone controller operation	238
HARDI 5500/6500 controller operation	239
LH5000 controller operation	240
Raven controller operation	241
Target Rate	242
Automatic Boom Switching	242
Rawson controller operation	242
Boom Height Control operation	243
Monitor boom height	244
Enable a control zone	244
Engage enabled zones	246
Adjust target height and aggressiveness	247
Disengage engaged zones	247
Single zone	247
All zones	248
Disable Boom Height Control	248
Single zone disabled	248
All zones disabled	248
Yield Monitoring operation	250
View map legend	250
Increase or decrease swath header swath width	250
Start and stop loads	251
Turn logging on or off manually	251
Track amount in grain bin	252
Coverage logging	253
Change coverage logging theme	253
Apply constant moisture value	253
Enter test weight of crop	253
Office Sync operation	255
Data transfer to Connected Farm	255
Receiving data from Connected Farm or FarmWorks	255
14 Appendix	257
Rate Control Setup	258

Contents

Row Crop Seed Setup	259
Row Monitoring Setup	260
Section Control Setup	261
Sensor Setup	262
Guidance screen buttons	263
Feature mapping buttons	268
Setting screen buttons	269
Automatic steering controls	271
Adjust aggressiveness	271
EZ-Steer and EZ-Pilot: Changing from forward to reverse	272

Safety Information

Always follow the instructions that accompany a Warning or Caution. The information it provides is intended to minimize the risk of personal injury and/or damage to property. In particular, observe safety instructions that are presented in the following format:

 **WARNING** – This alert warns of a potential hazard which, if not avoided, could result in severe injury or even death.

 **CAUTION** – This alert warns of a potential hazard or unsafe practice which, if not avoided, could result in injury or property damage or irretrievable data loss.

Note – *An absence of specific alerts does not mean that there are no safety risks involved.*

Warnings

Auto guidance

 **WARNING** – Obstacles in the field can cause collisions, which may injure you and damage your vehicle. If an obstacle in the field makes it unsafe to continue a particular phase of the automated dead-zone calibration, stop the vehicle to abort the phase and turn the steering wheel to disengage the system. Reposition the vehicle and continue from the current test phase.

 **WARNING** – Auto guidance systems cannot avoid items in the field such as obstacles. Make sure you are adequately trained to operate the auto guidance system.

 **WARNING** – Many large and sudden changes in satellite geometry caused by blocked satellites can cause significant position shifts. If operating under these conditions, auto-guidance systems can react abruptly. To avoid possible injury or damage to property under these conditions, disable the auto-guidance system and take manual control of the vehicle until the conditions have cleared.

Calibration

 **WARNING** – Incorrect adjustment of the Manual Override Sensitivity calibration could cause this critical safety feature to fail, resulting in personal injury or damage to the vehicle. Do not choose a setting that is either too sensitive or not sensitive enough. It is vital to avoid setting the sensitivity so low that the system will not detect any steering wheel motion.

-  **WARNING** – During the Deadzone calibration, the system moves the vehicle’s steering wheel. To avoid injury, be prepared for sudden vehicle movement.
-

NH3, anhydrous ammonia

-  **WARNING** – Anhydrous valve and flow calibrations require the vehicle and implement to be moving and the implement must be in the ground (the implement lift switch must be down). Take all necessary precautions to ensure user safety. Failure to do so may result in serious injury or death.
-

-  **WARNING** – Anhydrous ammonia (NH3) can cause severe burning, blindness, or death. NH3 is an irritant and corrosive to the skin, eyes, respiratory tract and mucous membranes, and is dangerous if not handled properly. It may cause severe burns to the eyes, lungs, and skin. Skin, and respiratory-related diseases could be aggravated by exposure. It is recommended that protective gloves, boots, slicker and/or pants and jacket, and chemical-splash goggles that are impervious to anhydrous ammonia are worn at all times. See [Safety Information, 17](#).
-

Cautions

Calibration

-  **CAUTION** – Failure to be in motion and in a straight path will cause performance problems after calibration.
-

Display

-  **CAUTION** – Do not use the Enable Advanced User Config feature unless you have the support of a Trimble Reseller. Altering any of the settings for this feature may cause system failure.
-

-  **CAUTION** – Do not press on the screen with a sharp item, such as a pencil or screwdriver. You may damage the surface of the screen.
-

EZ-Pilot system

-  **CAUTION** – Before you leave the vehicle, turn off the power to the display which will turn off the EZ-Pilot system power.
-

-  **CAUTION** – If you use the vehicle on a public roadway, you must put the red EZ-Pilot system override switch in the off position.
-

 **CAUTION** – Do not operate the EZ-Pilot system while driving in reverse gear.

GNSS

 **CAUTION** – The GNSS antenna may experience interference if you operate the vehicle within 100 m (300 ft) of any power line, radar dish, or cell phone tower.

 **CAUTION** – You must select the correct base datum for your location. If you select an incorrect value, this will result in an incorrect xFill operation.

Prescriptions

 **CAUTION** – For the system to work correctly, you must select the correct Rate Column setting. If you do not, the applied rate will be incorrect.

Installation

 **CAUTION** – Do not mount the DCM-300 modem in direct sunlight or in areas of high heat. This will cause degraded performance.

USB socket

 **CAUTION** – Do not remove the USB drive from the socket while the display is writing to or from the drive. This will corrupt the data.

Working with anhydrous ammonia

- Contact your NH₃ supplier to review all safety requirements associated with anhydrous ammonia (NH₃).
- Always wear correct personal protective equipment. This includes, but is not limited to:
 - Goggles or face shield
 - Protective suit and gloves
 - Respirator
- Do not allow anyone to operate the system without proper instruction and training.
- Stand up-wind when working around NH₃ and related equipment.
- Always keep NH₃ equipment away from buildings, livestock, and other people.

- Never work on NH₃ equipment in confined spaces.
- Before you attempt to transport the implement, discharge the system of all NH₃ and completely shut down the system. See [Discharging the System , 20](#).
- If symptoms of illness occur during or shortly after use of NH₃ products, seek immediate medical attention.
- Keep a source of clean water (at least five gallons) readily available. In case of exposure, flush exposed skin or eyes immediately with large quantities of water and seek immediate medical attention.
- NH₃ can be harmful to the environment if not used correctly. Follow all local, state, and federal regulations regarding proper handling of this chemical.

Servicing the Equipment

1. Remove the system from operation before performing any maintenance.
2. Thoroughly bleed all system lines and disconnect the nurse tank hose. See [Discharging the System , 20](#).
3. Make sure that the gauge pressure is at zero before you open the system.
4. Use extreme caution when opening a previously pressurized system.

Discharging the System

1. Turn off the console or vehicle master switch.
2. Completely close the main shut-off valve on the supply or nurse tank.
3. Resume field application until the pressure gauge shows zero pressure.
4. Check again that the console and/or vehicle master switch, and all section switches, are turned off.
5. Completely close the emergency shut-off valve the cooling tower.
6. Bleed and disconnect the nurse tank supply hose from the system.
7. Turn on the console master switch and all section switches.
8. Stand up-wind from the implement and then slowly open the bleed valve(s) until fully open.
9. Allow at least one (1) hour for the system to fully discharge.
10. Before you open the system, make sure that the pressure gauge on the manifold reads zero and that the cooling tower is not cold to the touch. This ensures that all liquid NH₃ has evaporated and that the pressure is discharged.

Note – Frost on any component is a positive indication of trapped NH₃ at low pressure. Lack of frost does not always indicate a lack of NH₃.

Introduction

In this chapter:

About the CFX-750 display	22
Changes to this document	22
Related information	22
Technical assistance	23

This manual describes how to:

- Install and connect the Trimble® CFX-750™ display as a standalone system
- Unlock and set up features

About the CFX-750 display

The Trimble® CFX-750 display is an in-cab touchscreen display that provides affordable guidance, steering and precision agriculture functionality.

The CFX-750 display includes a built-in GNSS receiver that you can upgrade to receive GLONASS satellite signals. The display can also use an array of features and components to maximize efficiency when planting, spraying, spreading and strip tilling, including the:

- Trimble Autopilot™ automated steering system with AutoSense™
- Trimble Field-IQ™ crop input control system using Tru Count Air Clutch valves, Tru Count Liquiblock™ valves, Rawson™ drives
- Trimble EZ-Pilot® assisted steering system with T3™ inertial terrain compensation technology
- Trimble EZ-Steer® assisted steering system with T2® roll calibration
- Trimble EZ-Remote™ joystick
- Trimble xFill™ technology
- OmniSTAR® corrections
- Trimble CenterPoint™ RTX™ corrections
- Trimble RangePoint™ RTX corrections
- Trimble VRS™ corrections
- Trimble FreeForm™ guidance pattern

Changes to this document

The changes for this document Version 7.0, Revision B are:

- Updated and more detailed information has been added about Office Sync. See [Office Sync setup, 180](#) and [Office Sync operation, 255](#)

Related information

Sources of related information include:

- Release notes: The release notes describe new features of the product, information not included in the manuals, and any changes to the manuals. The release notes are available at www.trimble.com.
- Trimble training courses: For more information, go to the Trimble website at http://www.trimble.com/Support/Index_Support.aspx.

Technical assistance

Contact your Trimble Reseller for technical assistance.

Installation

In this chapter:

System components	26
Install the CFX-750 display	27
Connect the CFX-750 display	29
Install external foot/rocker switch	32

To install the CFX-750 display as a standalone system, you install the mount, display and antenna. Optionally, you can install an external foot / rocker switch.

System components



Number	Description
①	CFX-750 display
②	RAM mount and screws
③	Quick reference card
④	Compact disc
⑤	GNSS antenna cable
⑥	Power bus/CAN cable
⑦	Power cable
⑧	AG-25 antenna
⑨	AG-25 antenna mount plate

Install the CFX-750 display

The steps to install the CFX-750 display include:

- [Installing the display mount](#)
- [Attaching the display to the mount](#)

Install the display mount

Install the display mount in the vehicle cab. When you position the display mount, make sure:

- The display will be within the driver's reach so that the USB drive is easy to remove and replace.
- The display's screen is easy to see, but does not block the driver's view.
- Neither the display nor mount will interfere with the driver getting in or out of the cab, or any other activities.

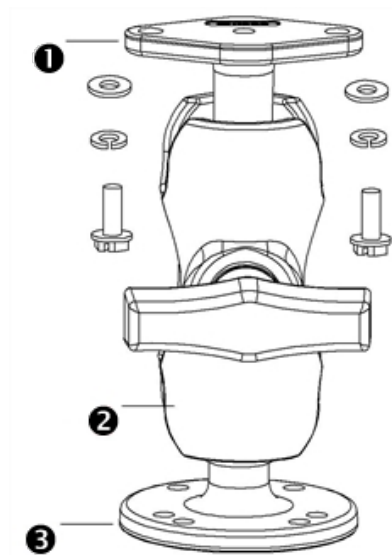

Item	Description
①	Diamond-shaped mounting plate
②	RAM mount
③	Bar mount

Attach the display to the mount

1. Use the supplied screws to firmly attach the diamond-shaped mounting plate to the back of the display.



2. Attach the RAM mount to the ball on the diamond-shaped mounting plate.



3. Select a position in the cab for the display. Hold the display in the selected location and check that it is easily accessible from the driver's seat.
4. Use the provided bolts to attach the bar mount to the cab.
5. Attach the other end of the RAM mount to the ball on the bar mount and then tighten the screw to hold the display in place.

Connect the CFX-750 display

This section covers connecting the display as a standalone system. For information on connecting the CFX-750 display to other the system components, see the *CFX-750 Display Cabling Guide*.

For WAAS/EGNOS/OmniSTAR® XP/HP corrections

All these corrections require the AG-25 GNSS antenna.



Item	Description	Trimble Part Number
①	CFX-750 display	94110-00
②	CFX-750 display power cable	77282
③	CFX-750 display basic power cable	67258-01
④	8 m GNSS TNC/TNC RT angle cable	50449
⑤	AG-25 GNSS antenna	77038

Also see: [Correction services setup, 168](#).

For RTK corrections

RTK corrections require a radio antenna. This setup requires an RTK password to use.



Item	Description	Trimble Part Number
1	CFX-750 display RTK password required.	94110-00
2	CFX-750 display power cable	77282
3	CFX-750 display basic power cable	67258-01
4	8 m GNSS TNC/TNC RT angle cable	50449

5	AG-25 GNSS antenna	77038
6	NMO-to-TNC 20 ft antenna cable and base	62120
7	900 MHz radio antenna kit	22882-10

Also see: [Correction services setup, 168](#).

Install and connect the antenna

Note – To minimize any interference to the GNSS signal, make sure that the GNSS antenna is at least 1 m (3 ft) from any other antenna (including a radio antenna). You may experience interference if you operate the vehicle within 100 m (300 ft) of any power line, radar dish, or cell phone tower.

1. Find the mounting location for the antenna at the front of the vehicle roof, centered from left to right.

Note – The AG-25 antenna has integrated magnets for easy installation. To attach the antenna to a non-metal surface, you must use the mounting plate.

2. On the mounting plate, remove the protective covers from the adhesive strips.
3. Attach the mounting plate to the vehicle roof with the adhesive strips. Ensure that the mounting plate is centered along the vehicle roof.
4. Connect the antenna cable to the antenna.
5. Place the antenna directly on the mounting plate. The three magnets embedded in the bottom of the antenna will hold it in place.
6. Route the other end of the antenna cable into the cab.

Install external foot/rocker switch

To install an optional foot or rocker switch:

1. Locate the foot or momentary rocker switch and the remote engage adapter cable (P/N 88506 - included with the foot switch kit, P/N 78150-00, or purchased separately).
2. Remove the wedge from a receptacle 3-pin Deutsch DTM.



3. For a foot switch, hold the receptacle with the lock facing upward with the black wire on the right-hand side, the white wire in the middle, and the green wire on the left-hand side.



Note – If you purchased P/N 78150-00, the correct connector is already attached.

4. For a rocker switch, insert the wires into the right and middle socket (the orientation does not matter).



5. For the rocker or foot switch, re-insert the wedge into the receptacle.



6. Connect the attached receptacle to the 3-pin DTM plug on the remote engage adapter cable.



7. Plug the other end of the remote engage adapter cable into the port replicator (pin 10 and pin 11) on the EZ-Pilot® cable that is connected to Port B on the CFX-750 display.



Note – If you are using a sonalert, you must remove engage pin 10 and move it to pin 8 so that the remote engage functions run between pin 8 and pin 11 and the sonalert functions between pin 2 and pin 10.

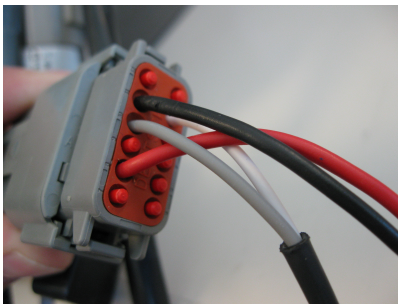

8. Route the cables of the footswitch or rocker switch to the required location.



Getting started

In this chapter:

Display basics	36
On-screen basics	43

This chapter includes:

- Display hardware
- Power on and off
- Resetting the display
- The basics of using the touchscreen and on-screen controls

Display basics

The basics include display:

- Hardware and how to clean the touchscreen
- Power on and off
- Reset

Display hardware

The CFX-750 display provides guidance, steering and precision agriculture functionality. With the display's touchscreen, you operate your system and to view guidance information. In addition, a USB port on the back of the display enables loading and saving field data.

⚠ CAUTION – Do not press on the screen with a sharp item, such as a pencil or screwdriver. You may damage the surface of the screen.

Front view of display



Item	Name	Explanation
1	8" Touch-sensitive screen	To interact with the system, tap the screen with your finger. Also see: <ul style="list-style-type: none"> • Clean the touchscreen, 42 • Recalibrate touchscreen, 198
2	Speaker	You can adjust the speaker volume, or turn it off. Also see: Display settings, 189
3	Integrated lightbar with 27 LEDs	When lit, the LEDs show the position of your vehicle relative to your intended guidance line. Also see: Lightbar patterns, 228

Back view of display



Item	Name	Explanation
❶	Power button	Turns the display on or off.
❷	USB socket	You can connect a USB drive to the display to transfer data to and from the unit. For more information, see Display hardware, 36 .
❸ and ❹	Brightness controls	To increase the brightness of the screen, tap ❸. To decrease the brightness, press ❹. You can also use the Color Scheme and Backlight menu options to set the screen brightness. See Display settings, 189 .
❺	GNSS connector	Connects the GNSS cable (P/N 50449) to the display.
❻	Port A	Connects external devices to the display.
❼	Power connection socket	Connects the power cable (P/N 67258) to the display.
❽	Port B	Connects external devices to the display.
❾	Radio access panel	If you purchase the optional RTK module, install the module here. For more information, see the installation instructions supplied with the radio module.

Power up

To turn on the CFX-750 display, tap the power button on the rear of the display. After a short time, the *Welcome* screen displays.

The first time you turn on the CFX-750 display, these screens display:

- *Touchscreen Calibration*
Follow the on-screen instructions to complete the calibration. See also [Recalibrate touchscreen, 198](#).
- *Quick Start Wizard*
To configure your system properly, make sure that you complete all the screens of the wizard. See [Quick start wizard, 39](#).

Note – A wizard is a set of screens to step you through a process in a specific sequence.

Power down



1. To turn off the CFX-750 display, hold down the power button for three seconds. The *Power Down In Progress* screen displays, showing a countdown to powering down.
2. To cancel the power down process, release the power button before the three-second countdown is complete.
3. If you wait for the three-second countdown, the system powers off.

Quick start wizard

With the *Quick Start Wizard*, you can configure settings before you begin driving. The first time you turn on the display, the wizard starts automatically. Make sure that when you first turn on the display that you complete all steps of the wizard.

When you use the wizard, you can choose whether or not it starts every time the display is turned on. If you choose to hide the wizard, the *Guidance* screen will display automatically when you turn the unit on again.

To access the wizard at another time other than the first-time power on:

1. Tap  at the *Guidance* screen.
2. At the *Settings* screen, tap .
3. Tap **Quick Start Wizard**. The *Welcome* screen displays.
4. Tap . The *Units* screen displays.
5. To set up your system, complete each screen of the wizard.

USB socket

Use the USB socket to transfer data with a USB drive. See [USB drive data transfer, 183](#).

The USB socket is on the rear of the display. See [Display hardware, 36](#).

Reset the display

If you need to reset the display, you can perform a [soft](#) or [hard](#) reset.

Soft reset

A soft reset returns all settings to the factory defaults. All saved field data remains intact.

To perform a soft reset on the display, see Soft Reset at [Advanced display settings, 192](#).

If you are not able to access the *Advanced* screen, you can use the buttons on the back of the display to perform a reset.

1. Power down the display and then power it on.
2. Wait until the status bar at the bottom of the startup screen is lighted to over 75% complete.



Note – This happens quickly. Be prepared to perform the next step.

3. Press the power button and the top brightness control button at the same time.



4. When you see another progress bar that counts up very slowly (one tick at a time), release the buttons.

Note – A soft reset needs approximately 10 minutes to complete. **Do not power down the display for 15 minutes after you have reset the display.**

5. After the reset is complete, recalibrate the touchscreen (see [Recalibrate touchscreen, 198](#)).

Note – If at any time you see the light bar LEDs slowly moving back and forth, the buttons were pressed too early. Power down the unit and repeat steps 1 through 4

Hard reset

A hard reset:

- Returns all settings to the factory defaults
- Deletes all saved data including any field data

To perform a hard reset on the display, see Hard Reset at [Advanced display settings, 192](#).

If you are not able to access the *Advanced* screen, you can use the buttons on the back of the display to perform a reset.

1. Power down the display and then power it on.
2. Wait until the status bar at the bottom of the startup screen is lighted to over 75% complete.



Note – This happens quickly. Be prepared to perform the next step.

3. Press the power button and both brightness control buttons at the same time.



4. When you see another progress bar that counts up very slowly (one tick at a time), release the buttons.

Note – A soft reset needs approximately 10 minutes to complete. **Do not power down the display for 15 minutes after you have reset the display.**

5. After the reset is complete, recalibrate the touchscreen (see [Recalibrate touchscreen, 198](#)).

Note – If at any time you see the light bar LEDs slowly moving back and forth, the buttons were pressed too early. Power down the unit and repeat steps 1 through 4

Take a screen shot

You can save a screenshot of the touchscreen for the purpose of collecting information for troubleshooting purposes. When you take a screenshot, the display saves a .png file to the root directory of the USB drive.

Note – Screenshot capability is available only when there is a USB drive inserted in the display.

To take a screenshot:

1. Put a USB drive into the USB socket.
2. Press **both** brightness control buttons at the same time.



3. Hold the buttons down until the touchscreen flashes.
4. When you are finished taking screenshots, remove the USB drive.

 **CAUTION** – Do not remove the USB drive from the socket while the display is writing to or from the drive. This will corrupt the data.

Clean the touchscreen

To clean the touchscreen of the CFX-750 display use:

- Ammonia-free glass cleaner (**Do not** apply glass cleaner directly to the touchscreen.)
 - Soft, lint-free cotton cloth
 - 50% isopropyl alcohol
1. Apply a small amount of glass cleaner to the cloth and gently rub it against the touchscreen.
 2. To clean off any stains or smudges, use a cotton cloth dampened with 50% isopropyl alcohol.



Tip – Clean the touch screen while it is powered down. It is easier to see dirt and fingerprints when the touch screen is dark.

On-screen basics

The basics of using the touchscreen include:

- Using on-screen buttons
- Understanding status icons
- How to hide and show on-screen controls
- The main screens

Touchscreen basics

With the touchscreen, you:

- [Tap buttons](#) to perform functions or choose an option
- [View status](#) indicated by an icon
- [Enter information](#)
- [Step through a process](#) in sequence using a wizard

Buttons

Buttons are on-screen controls that you tap to perform a function such as:

- Save a setting
- Go to another or previous screen
- Begin automatic guidance
- Choose an item

Some buttons also show a status of a function.

Note – *Buttons are available only when they are appropriate. They are not visible at all times.*







If the display does not respond when you tap a button, see [Recalibrate touchscreen, 198](#).

Icons indicating status

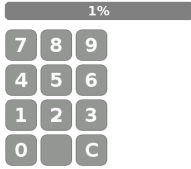
Icons are graphics (sometimes including labels or text) that provide information or status about a feature or system component. You cannot tap an icon to perform a function.

Note – *Icons display only when they are appropriate. They are not visible at all times.*

Entering information

To...	Tap...
Enter information	The text or number entry box on the screen that displays the required value. As you enter information, the text or number changes color from gray to green.
Enter the numbers that you require	
Enter text	
Save and go to the next screen	
Save and leave the current screen	
Go to a previous screen	
Go back to the previous screen	

Wizards

The CFX-750 display contains various "wizards." A wizard is a series of screens that step you through a specific process.

On-screen help

To view on-screen help, tap the help button.



Guidance screen





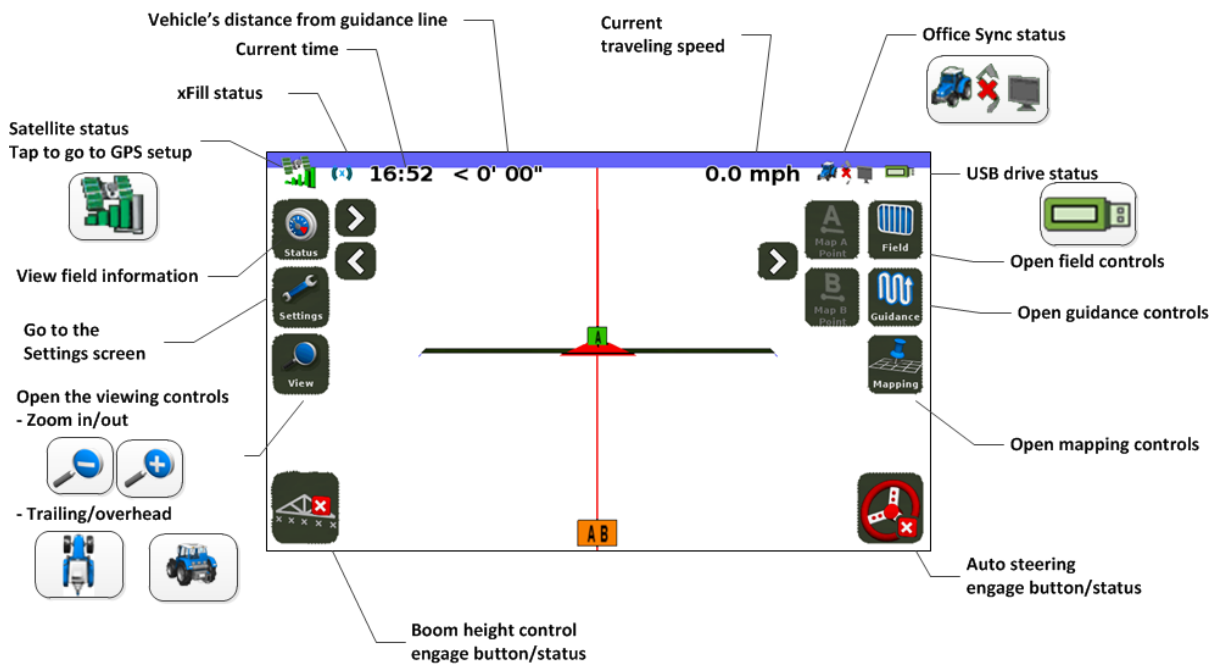







The *Guidance* screen displays buttons to access functions and icons to provide status and information.











Note – *The setup of your system determines what buttons and status icons show on the screen. For example, some buttons and status icons are not available while you are using an auto steering system.*

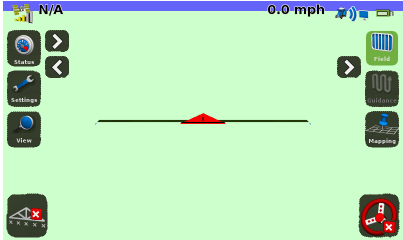

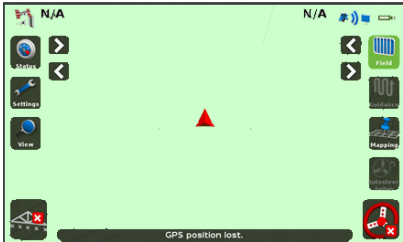















If the display does not respond when you tap it, see [Recalibrate touchscreen, 198](#).















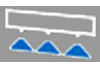

Buttons on *Guidance* screen

Button	Function	Tap to.../Indicates...
	Status	<p>See the status of field information and move the status information left or right to expose the Camera features (Camera A and Camera B).</p> <p>To rotate through the status information you keep tapping .</p> <p>Tap  to see the next view.</p> <p>Tap  to see the previous view.</p> <div data-bbox="799 835 1406 1137" style="border: 1px solid black; padding: 5px; background-color: #333; color: white; margin-top: 10px;">  <p>The screenshot shows a dark green interface with a 'Status' button (gauge icon) and a 'Settings' button (wrench icon) on the left. In the center are right and left arrow buttons. On the right, the following field information is displayed:</p> <ul style="list-style-type: none"> Field Name: 083110_0001 Field Area: 0.00 a Productive Area: 0.00 a Coverage: 0.00 a Nudge: 0" Imp. Width: 60' 00" Overlap: 0" Storage: 595.4 hrs </div>
	Settings See Settings screen, 50	<p>Go to the <i>Settings</i> screen to navigate to setup screens:</p> <ul style="list-style-type: none">  <i>Vehicle</i>  <i>Implement</i>  <i>Guidance</i>  <i>GNSS</i>  <i>Data</i>  <i>System</i> <p>To collapse the view, continue to tap .</p>

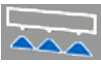
Button	Function	Tap to.../Indicates...
	View	Open view controls.
		Toggles the view from overhead view to trailing view.
		
		Toggles the view from trailing view to overhead.
		
		Note – By default, the view switches from Overhead to Trailing when you approach the AB line.
		Zoom in
		Zoom out
		Hide the view controls.
	Hide or show controls.	 to show hidden controls.  to hide controls.

Button	Function	Tap to.../Indicates...
	Toggle to show or hide controls.	A shortcut to removing the controls so you can view the guidance line labels.
	Toggle to show or hide controls.	A shortcut to removing the controls so you can view the guidance line labels.
	Opens mapping controls	See Map guidance and features, 202 .
	Opens auto steering setup	
	Opens field controls	See Fields, 217 .
	Disengage the automatic steering system	To disengage the auto steering system. Indicates you are currently automatically steering on a guidance line/pattern.
	Indicator only	Indicates the automatic steering system cannot be used.
	Engage the automatic steering	To engage. Indicates the automatic steering is ready to be engaged.
	Activate external video input	
	View full screen external video	To replace guidance screen with video feed. Tap again to resume guidance screen viewing.





Button	Function	Tap to.../Indicates...
	Status of data transfer for Office Sync	<p>Indicates:</p> <ul style="list-style-type: none"> If field data is being sent or received, an icon at the top right of the screen displays. If data is being sent or received, an orange arrow blinks between the tractor and office computer. <p>Tap this button to see details, including network status and transfer status.</p>
 (White)	Status of xFill	Indicates xFill is ready
 (Blue)	Status of xFill	Indicates xFill is engaged, has been used between 0 and 15 minutes
 (Red)	Status of xFill	Indicates xFill is engaged, and 5 minutes remain
	Forward movement	<p>For EZ-Pilot and EZ-Steer® assisted steering system, indicates you are traveling forward.</p> <p>See EZ-Pilot system operation, 222 or EZ-Steer system operation, 219.</p>
	Reverse movement	<p>For EZ-Pilot and EZ-Steer system, indicates you are traveling in reverse.</p> <p>See EZ-Pilot system operation, 222 or EZ-Steer system operation, 219.</p>

Button	Function	Tap to.../Indicates...
	Coverage logging status See Guidance settings, 146 .	On:  (Green with checkmark) Off:  (Gray with red X) Inactive:  (Gray)
 	Virtual Section Switch for Field-IQ See Field-IQ operation, 230 .	Shows the current section mode for the controller. Automatic:  Manual: 
 	Virtual Master Switch for Field IQ See Field-IQ operation, 230 .	Shows the Master Switch status. On:  Off: 
 	Section control for Field-IQ See Field-IQ operation, 230 .	Automatic:  Manual: 

Settings screen

At the *Settings* screen, you can navigate to all the settings. To access the *Settings* screen, tap  at the *Guidance* screen.



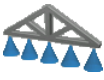

Buttons on the *Settings* screen

Tap...	To go to...	To complete functions, including...
	<i>System</i> screen	<ul style="list-style-type: none"> • Quick Start Wizard (see Quick start wizard, 188) • Display settings (see Display settings, 189) • Advanced settings (see Advanced display settings, 192) <ul style="list-style-type: none"> • Save/Load Configurations • Digital Output • Advanced User Configurations • NMEA Output • Status (see Status, 196) • About the Display (see About the display, 198) • Restore Defaults (see Restore defaults, 198) • Calibrate Touchscreen (see Recalibrate touchscreen, 198)
	<i>GNSS</i> screen	<ul style="list-style-type: none"> • Set up GNSS, position quality and advanced settings (see GNSS setup, 166) • View status of GNSS, satellite, DGPS (see GNSS setup, 166)
	<i>Data</i> screen	<ul style="list-style-type: none"> • Manage Data (see Data management, 178) • Set up Office Sync (see Office Sync setup, 180)
	<i>Guidance</i> screen	<ul style="list-style-type: none"> • Turn Settings (see Guidance settings, 146) • Coverage Settings (see Guidance settings, 146) • Nudge Settings (see Guidance settings, 146) • Mapping settings (see Guidance settings, 146) • FreeForm Recording (see Guidance settings, 146) • Headland/Infill Switching (see Guidance settings, 146) • Boundary Setup (see Guidance settings, 146)
	<i>Implement</i> screen	<p>Set up:</p> <ul style="list-style-type: none"> • Implement (see Field-IQ setup for implements, 119) • Application Control (see Section Control setup, 130) • Boom Height Control (see Field-IQ Boom Height Control setup, 142) • Yield Monitoring (see Yield Monitoring setup, 156)

Tap...	To go to...	To complete functions, including...
	Vehicle screen	Set up and view status of automatic steering (see EZ-Steer steering system, 56 , EZ-Pilot system setup, 62 , Autopilot system setup, 68)

Navigation controls





To navigate between screens, tap the appropriate button.

Button	Function	Button	Function
	Go to next screen		Cancel changes
	Go to previous screen		Accept / save changes

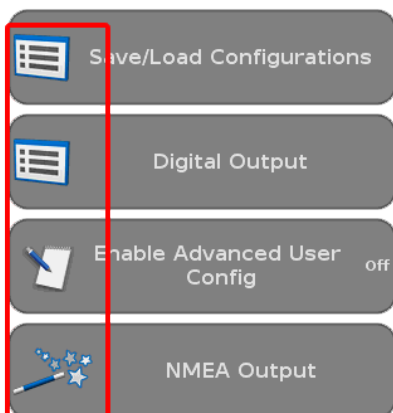
Icons on buttons

The icons on buttons in the settings screens are an indication of the additional screens they lead to.





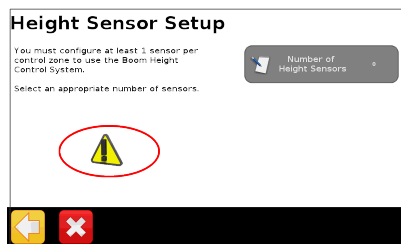

Button	Function	Button	Function
	Menu		Setup wizard
	Configure		Status
	Enter or edit information		

Information icons

Some screens include an icon to help you quickly determine the type of information on the screen.



Icon	Indicates...	Icon	Indicates...
	Setup complete		General alert
	Critical warning		Information

Vehicle guidance setup

In this chapter:

EZ-Steer steering system	56
EZ-Pilot steering system	62
Autopilot steering system	68
Foot or rocker switch setup	85
EZ-Remote Joystick custom settings	86

You can configure the CFX-750 display to use automatic steering systems for your vehicle, including EZ-Steer system, EZ-Pilot system and Autopilot system.

EZ-Steer steering system

The EZ-Steer auto steering system enables you to automatically steer your vehicle on a guidance line or pattern you create using the CFX-750 display.

- Setup (see [EZ-Steer system setup, 56](#))
- Calibration (see [EZ-Steer system calibration, 59](#))
- Operation (see [EZ-Steer system operation, 219](#))

EZ-Steer system setup

To view and adjust the settings for the EZ-Steer system:

1. At the *Guidance* screen, tap .

2. At the *Settings* screen, tap .

3. Tap **Auto Steer** and then **EZ-Steer Setup**.

Note – If the *EZ-Steer Setup* button does not display, tap *Auto Steer System Type* and then tap *EZ-Steer* for your controller.

4. Complete the settings for setting up the EZ-Steer system.

5. After settings are complete, calibrate the EZ-Steer system (see [EZ-Steer system calibration, 59](#)).

EZ-Steer setup is divided into these categories:

- [Engage Options](#)
- [Vehicle Setup](#)
- [Aggressiveness](#)
- [Advanced](#)
- [EZ-Steer Demo](#)

Engage Options

Setting	Explanation
Minimum/Maximum speed	Disengagement speed for the EZ-Steer system: <i>Minimum</i> : between 1.0 and 15.9 mph (1.6 and 25.5 kph). <i>Maximum</i> : between 1.0 and 18.0 mph (1.6 and 28.8 kph).

Setting	Explanation
Maximum Angle	The system will not engage when the vehicle is heading toward the guidance line at an angle greater than the Maximum Angle. Enter an angle between 5 and 45 degrees.
Engage/Disengage Offline	<ul style="list-style-type: none"> Engage offline: The system will not engage when the vehicles distance from the guidance line is offline further than this distance. Enter a distance between 0' 5" and 27' 0" (0.2 and 8.2 m). Disengage offline: The system will automatically disengage when the vehicle is offline further than this distance. Enter a distance between 0' 6" and 27' 00" (0.2 m and 8.2 m).
Engage/Disengage Offline	<ul style="list-style-type: none"> Engage offline: The system will not engage when the vehicle is offline further than the Engage Offline distance. Enter a distance between 0' 5" and 27' 0" (0.2 and 8.2 m). Disengage offline: The system will automatically disengage when the vehicle is offline further than the Disengage Offline distance. Enter a distance between 0' 6" and 27' 00" (0.2 m and 8.2 m).
Override sensitivity	How much force is required to disengage the system. Enter an increment between 1-100%.
EZ-Steer external switch	Enable or disable additional safety features.
EZ-Steer operator timeout	Enter a time between 1-60 minutes.

Vehicle Setup

Setting	Explanation
Vehicle type	Enter the type of vehicle on which the EZ-Steer system will be installed.
Wheelbase	See Vehicle Measurements in EZ-Steer system calibration, 59
Antenna height	See Vehicle Measurements in EZ-Steer system calibration, 59
Antenna to axle offset	See Vehicle Measurements in EZ-Steer system calibration, 59
Angle per turn	Adjust the angle that the wheels turn during one full rotation of the steering wheel. Enter an angle between 2-149 degrees.

Setting	Explanation
Freeplay left/right	Adjust this setting if the vehicle is consistently off to the right or left of the guidance line. Enter a measurement of 0-12" (0-30.48 cm).
Motor speed	Control the speed of the EZ-Steer drive wheel motor.
Motor direction is reversed	Yes or no.
Sprayer steering delay	Accounts for time lags with vehicle steering when using a sprayer. Enter a value between 0.1-1.5.
Swather steering delay	Accounts for time lags with vehicle steering when using a swather. Enter a value between 0.1-1.5.

Aggressiveness

Setting	Explanation
Online aggressiveness	How aggressively the EZ-Steer system corrects deviations from the guidance line. Enter a value between 50-150%.
Approach aggressiveness	How fast the EZ-Steer system steers the vehicle onto the guidance line. Enter a value between 50-150%

Advanced

Setting	Explanation
Roll Offset Angle	
Estimate Steering Angle Bias	Turn on to enable the ability to drive the offline distance to zero.
Dynamic Approach Angle	Turn on to have a more aggressive line acquisition.
Steering Slew Limit	For smoother steering, raise the value. Note – A value too low will cause instability.
Steering Acceleration Limit	For smoother steering, raise the value. Note – A value too low will cause instability.

EZ-Steer Demo

Note – EZ-Steer Demo Mode requires an EZ-Steer controller, motor, and EZ-Steer simulator stand (P/N 54836-00).

This option is available if you have loaded the vehicle demo type from the Vehicle Database (VDB). (See [Load VDB, 70.](#))



EZ-Steer Demo Mode is useful for practice with defining fields, coverage logging, and assisted steering.

EZ-Steer system calibration

Before you begin to use the CFX-750 display with the EZ-Steer system, you must complete calibration steps.

To do this, complete the Quick Start Wizard (see [Quick start wizard, 39](#)) that displays the first time you use the CFX-750 display.

Note – You must have GNSS connected to complete calibration.

1. First set up the EZ-Steer system (see [EZ-Steer system setup, 56](#)).
2. At the *Guidance* screen, tap .
3. At the *Settings* screen, tap .
4. At the *Vehicle* screen, tap **Auto Steer Setup**.
5. At the *EZ-Steer Setup* screen, tap **EZ-Steer Calibration Wizard**.

The wizard guides you through:

- [Vehicle measurements](#)
- [T2[®] roll calibration](#)
- [EZ-Steer system calibration](#)

Vehicle measurements

For optimum guidance, you must take accurate vehicle measurements and enter them into the display.

Note – Do not enter calibration numbers from EZ-Guide[®] Plus or EZ-Steer[®] T2 systems. This may cause very poor vehicle control, including swerves and/or large oscillations.



To streamline the calibration process, you may want to take the vehicle measurements and record them for entry later on.

The techniques for taking vehicle measurements are described as follows. Also see [EZ-Steer system setup, 56](#) for information on vehicle measurements.

Before you take the measurements, position your vehicle as follows:

- Park the vehicle on level ground.
- Make sure that the vehicle is straight, with the centerline of the body parallel to the wheels.

Take the vehicle measurements.

To measure...	Measure from the...
Wheelbase 	Center (the axle) of the front wheel to the center of the back wheel. Note that the wheelbase measurement for: <ul style="list-style-type: none"> • Tracked vehicles is exactly half of the length of the track. • Articulated 4WD vehicles is half of the distance between the center of the front and rear wheels.
Antenna height 	Ground to the top of the GNSS antenna.
Antenna to axle offset 	Center (the axle) of the front or rear wheel to the top of the GNSS antenna. Note – Make sure that you take this measurement to within 7.6 cm (3 in.) as an incorrect distance may result in poor steering performance. Take the measurement from the antenna to the correct point of your vehicle: <ul style="list-style-type: none"> • Rear axle: <ul style="list-style-type: none"> • MFWD • Sprayer • Floater • Truck • Front axle: <ul style="list-style-type: none"> • 4wd tractor • Combine • Track center: Tracked tractor If the antenna is: <ul style="list-style-type: none"> • In front of the axle, enter a Forward distance • Behind the axle, enter a Behind distance



T2 roll calibration

T2 roll sensor calibration enables the display to handle terrain compensation in the EZ-Steer controller. This step requires you to:

1. Enter an accurate value for controller orientation.
2. Park the vehicle and mark the inside of both sets of wheels.
3. Remain stationary while the system calculates the roll offset. This takes approximately 20 seconds.
4. Turn the vehicle around and ensure the wheels are over the positions marked in the previous step.
5. Remain stationary while the system calculates the roll offset. This takes approximately 20 seconds.

EZ-Steer system calibration

In this step you must drive and engage on a straight AB line in a clear field:

1. Begin driving and then tap .
2. Drive 160 feet and then tap . A series of calibration screens will allow you to adjust any settings as necessary.

EZ-Pilot steering system

The EZ-Pilot auto steering system enables you to automatically steer your vehicle on a guidance line or pattern you create using the CFX-750 display.

- Setup (see [EZ-Pilot system setup, 62](#))
- Calibration (see [EZ-Steer system calibration, 59](#))
- Operation (see [EZ-Pilot system operation, 222](#))

EZ-Pilot system setup

To view and adjust the settings for the EZ-Pilot system:

1. At the *Guidance* screen, tap .

2. At the *Settings* screen, tap .

3. Tap **Auto Steer** and then **EZ-Pilot Setup**.

Note – If the *EZ-Pilot Setup* button does not display, tap *Auto Steer System Type* and then tap *EZ-Pilot for your controller*.

4. Complete the settings for setting up the EZ-Pilot system.

5. After settings are complete, calibrate the EZ-Pilot system (see [EZ-Pilot system calibration, 64](#)).

EZ-Pilot setup is divided into these sections:

- [Engage Options](#)
- [Vehicle Setup](#)
- [Aggressiveness](#)
- [Advanced](#)
- [EZ-Pilot demo mode](#)

Engage Options

Setting	Explanation
Minimum/Maximum speed	Enter the minimum and maximum speeds at which the EZ-Pilot system will disengage: <ul style="list-style-type: none"> • Minimum: between 1.0 and 15.9 mph (1.6 and 25.5 kph) • Maximum: between 1.0 and 18.0 mph (1.6 and 28.8 kph)

Setting	Explanation
Maximum Angle	<p>The EZ-Pilot system will not engage when the vehicle is heading toward the guidance line at an angle greater than the Maximum Angle.</p> <p>Enter an angle between 5 and 45 degrees.</p>
Engage/Disengage Offline	<ul style="list-style-type: none"> Engage offline: The system will not engage when the vehicle is offline further than this distance. Enter a distance between 0' 5" and 27' 0" (0.2 and 8.2 m). Disengage offline: The system will automatically disengage when the vehicle is offline further than this distance. Enter a distance between 0' 6" and 27' 00" (0.2 m and 8.2 m).
Override sensitivity	How much force is required to disengage the system. Enter an increment between 1-100%.
Operator timeout	Enter a time between 1-60 minutes.

Vehicle Setup

Setting	Explanation
Vehicle type	The type of vehicle on which the EZ-Pilot system will be installed.
Wheelbase	See Vehicle Measurements In EZ-Pilot system calibration, 64 .
Antenna height	See Vehicle Measurements In EZ-Pilot system calibration, 64 .
Antenna to axle offset	See Vehicle Measurements In EZ-Pilot system calibration, 64 .
Freeplay left / right	<p>Drives consistently to one side of the line.</p> <ul style="list-style-type: none"> If the vehicle is offline to the left, increase the Freeplay offset to the right. If the vehicle is offline to the right, increase the Freeplay offset to the left.
Motor speed	The speed of the EZ-Pilot drive wheel motor.

Aggressiveness

Setting	Explanation
Online aggressiveness	How aggressively the EZ-Pilot system corrects deviations from the guidance line. Enter a value between 50-150%.
Approach aggressiveness	How fast the EZ-Pilot system steers the vehicle onto the guidance line. Enter a value between 50-150%

Advanced

Setting	Explanation
Roll Offset Angle	
Estimate Steering Angle Bias	Turn on to enable the ability to drive the offline distance to zero.
Dynamic Approach Angle	Turn on to have a more aggressive line acquisition.
Steering Slew Limit	For smoother steering, raise the value. Note – A value too low will cause instability.
Steering Acceleration Limit	For smoother steering, raise the value. Note – A value too low will cause instability.

EZ-Pilot Demo

EZ-Pilot Demo Mode is useful for practice with defining fields, coverage logging, and assisted steering.

Note – EZ-Pilot Demo Mode requires an EZ-Pilot controller, motor, and EZ-Pilot simulator stand.



This option is available if you have loaded the vehicle demo type from the Vehicle Database (VDB). (See [Load VDB, 70.](#))

EZ-Pilot system calibration

Before you begin to use the display, you must calibrate the EZ-Pilot system. To do this, complete the Quick Start Wizard (see [Quick start wizard, 188](#)), that displays the first time that you use the display.

Note – You must have GNSS connected.

To calibrate the EZ-Pilot system at a later time:

1. At the *Guidance* screen, tap .
2. At the *Settings* screen, tap .
3. Tap **Auto Steer** and then **EZ-Pilot Setup**.

Note – If the *EZ-Pilot Setup* button does not display, tap *Auto Steer System Type* and then tap *EZ-Pilot* for your controller.

At the *EZ-Pilot Setup* screen, tap **EZ-Pilot Calibration Wizard**. The wizard steps you through:

- [Vehicle measurements](#)
- [T3™ roll calibration](#)
- [Angle per turn calibration](#)
- [EZ-Pilot system calibration](#)

Vehicle measurements



For optimum guidance, you must take accurate vehicle measurements and enter them into the display.

Note – Do not enter calibration numbers from *EZ-Guide® Plus* or *EZ-Steer* systems. This may cause very poor vehicle control, including swerves and/or large oscillations.

To streamline the calibration process, you may want to take the vehicle measurements and record them for entry later on.

The techniques for taking vehicle measurements are described below. Also see [EZ-Steer system setup, 56](#) for information on vehicle measurements.

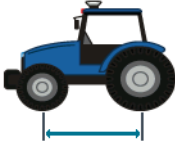
1. Before you take the measurements:
 - a. Park the vehicle on level ground.
 - b. Make sure that the vehicle is straight, with the centerline of the body parallel to the wheels.
2. Take the vehicle measurements.

To measure...	Measure from the...
Wheelbase 	Center (the axle) of the front wheel to the center of the back wheel. Note that the wheelbase measurement for: <ul style="list-style-type: none"> • Tracked vehicles is exactly half of the length of the track. • Articulated 4WD vehicles is half of the distance between the center of the front and rear wheels.
Antenna height 	Ground to the top of the GNSS antenna.
Antenna to axle offset 	Center (the axle) of the front or rear wheel to the top of the GNSS antenna. Note – Make sure that you take this measurement to within 7.6 cm (3 in.) as an incorrect distance may result in poor steering performance. Take the measurement from the antenna to the correct point of your vehicle: <ul style="list-style-type: none"> • Rear axle: <ul style="list-style-type: none"> • MFWD • Sprayer • Floater • Truck • Front axle: <ul style="list-style-type: none"> • 4wd tractor • Combine • Swather Note – For swathers, it is recommended that you put the antenna directly above the front axle or slight ahead. <ul style="list-style-type: none"> • Track center: Tracked tractor If the antenna is: <ul style="list-style-type: none"> • In front of the axle, enter a Forward distance • Behind the axle, enter a Behind distance

T3 terrain compensation calibration

The T3 roll sensor enables the display to handle terrain compensation in the IMD-600 unit.

1. Enter an accurate value for the IMD-600 orientation.



2. Park the vehicle and mark the inside of both sets of wheels.
3. Remain stationary while the system calculates the roll offset. This takes approximately 20 seconds.
4. Turn the vehicle around and ensure the wheels are over the positions marked in the previous step.
5. Remain stationary while the system calculates the roll offset. This takes approximately 20 seconds.

Angle Per Turn calibration

First set the IMD-600 orientation and perform the T3 terrain compensation calibration.

You must operate the vehicle in an open field with ample area for the vehicle to make right and left turns.



1. Tap **Right Angle-Per-Turn Calibration**.
2. Drive forward until  (yellow) displays and then tap the icon.

Note – For the best results drive the vehicle between 2 and 4 mph.

Allow the system to operate for 20 seconds until you receive a message that the calibration is complete.

3. Repeat Step 1 through Step 2 for left angle-per-turn calibration.

EZ-Pilot system calibration

1. In a clear field, begin driving and tap .
2. Drive 160 feet and then tap .



A series of calibration screens enable you to adjust any settings as necessary.

Autopilot steering system

The Autopilot auto steering system enables you to automatically steer your vehicle on a guidance line or pattern you create using the CFX-750 display.

- Autopilot setup and calibration (See [Autopilot system setup, 68](#))
- Advanced settings (See [Advanced settings for the Autopilot system, 81](#))
- Status and diagnostics (See [Status/Diagnostics for the Autopilot system, 82](#))
- Saving or restoring a vehicle configuration file (See [Save or restore vehicle configuration file, 84](#))
- Autopilot operation (See [Autopilot system operation, 224](#))

Autopilot system setup

1. At the *Guidance* screen, tap  .
2. At the *Settings* screen, tap .
3. At the *Vehicle* screen, tap **Auto Steer**
4. At the *Auto Steer Setup* screen, tap **Autopilot**.
5. Tap **Autopilot Setup**.
6. At the *Autopilot Setup* screen, complete the settings as appropriate.

Note – The buttons displayed depend on the configuration of the vehicle loaded from the vehicle database (VDB) or from a restored vehicle configuration.

Setting	Explanation
Load VDB	Access the Trimble Vehicle Database for basic setup by loading it from a USB drive. See Load VDB, 70 .
Manual Override	Adjusts how much force is required to disengage the system when the driver turns the steering wheel for pressure transducer and some quadrature encoder systems. Depending on the manual override method, this option may not be available. See Manual Override, 70 .
Controller Orientation	Determines the position/orientation of the controller as it is currently installed in the vehicle. See Controller Orientation, 71 .

Setting	Explanation
Line Acquisition	<p>How aggressively the Autopilot system commands the vehicle to steer to the current guidance line.</p> <p>Note – <i>If Line Acquisition is set higher than the steering capabilities of the vehicle hydraulic system, instability may occur. Check the stability at the indicated speed.</i></p> <p>See Line Acquisition, 72.</p>
Steering Sensor Calibration	<p>The reported steering potentiometer voltage output into an equivalent measurement for the steering angle.</p> <p>To set up AutoSense™ sensors, go to Auto Steer Setup / Advanced Settings / Autopilot Operations / Autopilot Steering Sensor.</p> <p>See Steering Sensor calibration, 73.</p>
Autopilot Automated Deadzone Calibration	<p>The minimum valve command required for steering movement.</p> <p>See Autopilot Automated Deadzone Calibration, 74.</p>
Autopilot Steering Gain Calibration	<p>The proportional gain value (PGain) to control vehicle steering overshoot and responsiveness.</p> <p>See Autopilot Steering Gain calibration, 76.</p>
Roll / Antenna Compensation	<p>The offsets to compensate for variations in the position of the NavController II and the mounting of the GNSS receiver.</p> <p>See Roll / Antenna Compensation, 78.</p>
Performance Settings	<p>Adjusts controller responsiveness to favor high accuracy or high stability in steering calculations (for supported sprayers and some swathers only).</p> <p>See Performance Settings, 81.</p>
Autopilot demo mode	<p>Note – <i>Autopilot Demo Mode requires an Autopilot controller, motor, and simulator stand.</i></p> <p>This option is available if you have loaded the vehicle demo type from the Vehicle Database (VDB). (See Load VDB, 70.)</p> <p>Autopilot Demo Mode is useful for practice with defining fields, coverage logging, and assisted steering.</p>

Load VDB

Note – Before loading a vehicle database into the CFX-750 display, go to Partners or contact your local reseller to obtain the most current Trimble VDB files and to determine which vehicle model is recommended for your installation.

To load a vehicle profile file from the Trimble Vehicle Database file:

1. Copy the vdb file to this location on a USB drive: **Root / AgGPS / Autopilot/ VDB.**
2. Insert the USB drive into the back port of the CFX-750 display.
3. At the *Autopilot Setup* screen, tap **Load VDB**. A number of upload warning messages displays.
4. Select the appropriate vehicle file for your vehicle based on recommendations from Partners or your Trimble Reseller and then tap .

A number of upload warning messages displays. The system restarts communication with the NavController II.

Manual Override



WARNING – Incorrect adjustment of the Manual Override Sensitivity calibration could cause this critical safety feature to fail, resulting in personal injury or damage to the vehicle. Do not choose a setting that is either too sensitive or not sensitive enough. It is vital to avoid setting the sensitivity so low that the system will not detect any steering wheel motion.

Note – The manual override sensitivity calibration is only valid for those platforms employing a pressure transducer for the manual override function.

It is strongly recommended that you perform this calibration only if it is determined that the default sensitivity is unacceptable under all operating conditions. The default sensitivity setting provides a balance between rapid activation of the override function and rejection of steering wheel motion due to incidental contact (for example, due to travel in a rough field).

Adjust the setting by incrementing the voltage setting up or down in increments of 0.10 V. Maximum and minimum voltage is established by vehicle and operational parameters.

The *Current Sensor Value* voltage or sensitivity is displayed along with the *Override* status that is based on comparing the setting value to the reported sensor value. When the threshold value is:

- Increased, the manual override function less is sensitive to steering movements.
- Decreased, the manual override function is more sensitive to steering wheel movements and will disengage Autopilot function sooner.



With the vehicle at a standstill:

1. Turn the steering wheel and notice the effort required to activate the *Override* status on the display.

2. Adjust the sensitivity level up or down by increasing or decreasing it in increments of 0.20 units.
3. Turn the steering wheel and assess whether the manual override feature is at an acceptable sensitivity level by evaluating the effort required against the *Override* status on the display.
4. Repeat Step 1 through Step 3 until the *Calibration* screen shows a suitable response.
It is recommended that you evaluate the performance of the manual override feature under loading conditions and / or during activities that may affect the pressure of the hydraulic system.
5. Tap  when Manual Override responds the best.

Controller Orientation

Note – *NavController II* images on the display represent the mounting orientation when viewed from the top looking down, and with the front of the tractor pointing at the top of the screen.

1. Choose the type of entry you want to perform for the controller orientation:
 - Orthogonal entry: Use this option if the mounting position of the control was completed in 90° increments around the X, Y, Z axis.
 - Direct entry: Use this option if the mounting position was done in known Roll, Pitch, Yaw degrees.
2. For orthogonal entry:
 - a. At the *Connector Orientation* screen, match the controller image on the screen to the same orientation (mounting direction) of the NavController II wiring connectors when viewed from above and with the front of the tractor pointing to the top of the display.
Ignore the reference direction of the NavController II labeling during this step.
When the correct connector orientation has been achieved, tap .
 - b. At the *Label Orientation* screen, match the controller image on the screen to the same orientation (mounting direction) of the NavController II Labeling Panel when this is viewed from above, and with the front of the tractor pointing to the top of the display.
Ignore the reference direction of the Nav II wiring connectors during this step.
When the correct label orientation has been achieved, tap .
3. For direct entry:
 - a. Enter the mounting angles of the controller in relation to the Roll = 0, Pitch = 0, Yaw = 0 state of the controller.
The 0,0,0 state of the controller is defined with the wiring connectors facing the rear of the

tractor, and the label panel facing up when viewed from above.

Direct Entry Axis	Explanation
Yaw	Rotation around the z-axis: Initially the front edge of the controller moves right and the back edge of the controller moves left.
Pitch	Rotation around the x-axis: Initially the front edge of the controller moves up, and the back edge of the controller moves down.
Roll	Rotation around the y-axis: Initially the left edge of the controller moves up and the right edge of the controller moves down.

- b. When the correct controller orientation is set, tap .

Line Acquisition

Line Acquisition enables you to fine-tune how the Autopilot system commands the steering hydraulics to approach the line.

Setting	Explanation
Line Acquisition Aggressiveness	<p>How fast the guidance system commands the vehicle to steer onto the current guidance line. The value can be adjusted to between 50% and 150% of the calculated value.</p> <ul style="list-style-type: none"> • With a higher setting, the vehicle approaches the line quickly, but may overshoot the line due to greater approach angles. • With a lower setting, the vehicle steers onto the line more slowly, but is less likely to overshoot the line due to lower approach angles. <p>Note – Test the line acquisition performance at, below, and above the speed specified in the Vehicle Stability Warning message on the Acquisition screen. Depending on the capabilities of the machine, higher line acquisition may cause instability due to the vehicle steering not being able to respond quick enough. This indicated speed value changes depending on the Line Acquisition Aggressiveness setting selected.</p>

Setting	Explanation
Engage Aggressiveness Note – <i>This option is not shown unless the function is enabled.</i>	<p>How aggressively the vehicle first reacts when you tap the engage button.</p> <ul style="list-style-type: none"> • With a higher setting, the vehicle will react faster and more aggressively when you press the engage button. • With a lower setting, the vehicle will react slower and smoother when you first press the engage button. <p>After adjusting the Steering Acquisition settings, re-evaluate the performance at, below, and above the normal operation speed of the Vehicle and Implement and make further adjustments as required.</p>

Steering Sensor calibration

The Steering Sensor calibration is required to convert the voltage output of the steering potentiometer into an equivalent measurement for the steering angle.

Note – *Complete this calibration first before attempting to calibrate the Steering Deadzone or Roll Corrections procedures.*

Note – *Steering sensor calibration is only performed if a rotatory potentiometer or hall-effect sensor is installed on the vehicle. If the steering angle sensor is set to AutoSense, the Steering Sensor Calibration screen does not display.*

To view or edit AutoSense settings, select Settings / Vehicle / Auto Steer Setup / Autopilot Operations / Autopilot Steering Sensor.

Pre-calibration

1. Carry out pre-calibration on a hard, level surface that is free of obstructions.
2. Follow the instructions that display on each screen of the display.
3. Make sure that the tractor speed exceeds 1.6 kph (1 mph) during the test phases.

Calibration procedure

Note – *To minimize the amount of open area space required for the complete calibration, you may reposition the vehicle between the phases of the test.*





1. Drive the vehicle to a large field that is without hazards or obstructions. The field should have smooth soil that is loose, but firm.
2. Enter the *Steering Sensor Calibration* wizard and then write down the *Sensor Voltage* and the *Steering Angle* when the wheels are straight, full left, and full right. This will be used for comparison purposes after you have run the test.

3. Run the calibration wizard, reading and following all on-screen instructions.

Note – If the steering wheel is not turned completely to either left or right positions when required, or if the steering sensor requires adjustment or replacement, you must adjust the sensor and then repeat the calibration.



CAUTION – Failure to be in motion and in a straight path will cause performance problems after calibration.

4. With the wheels steering:
 - a. Straight, move the vehicle slowly forward and then tap .
 - b. Full left, continue to move slowly forward and then tap .
 - c. Full right, continue to move slowly forward and then tap .
 - d. Straight, continue to move slowly forward and then tap .
5. After the calibration is complete the Sensor Voltage and Steering Angle results display. Watch the steering angle to ensure:
 - a. A systematic angle reading at the steering extremes when you manually steer the wheels full right and full left.
 - b. That the angle reading is near zero when you manually steer the wheels straight ahead.If required, repeat the calibration procedure.
6. Verify that the voltage and angle are both acceptable, then tap .

Autopilot Automated Deadzone Calibration



WARNING – Many large and sudden changes in satellite geometry caused by blocked satellites can cause significant position shifts. If operating under these conditions, auto-guidance systems can react abruptly. To avoid possible injury or damage to property under these conditions, disable the auto-guidance system and take manual control of the vehicle until the conditions have cleared.



WARNING – Obstacles in the field can cause collisions, which may injure you and damage your vehicle. If an obstacle in the field makes it unsafe to continue a particular phase of the automated dead-zone calibration, stop the vehicle to abort the phase and turn the steering wheel to disengage the system. Reposition the vehicle and continue from the current test phase.

Note – The Steering Sensor Setup and calibration must be performed before you run this procedure, and the vehicle's hydraulic fluid must be at operation temperature.

By turning the vehicle to the right and to the left, the Autopilot Automated Deadzone Calibration runs a series of tests on the valve and steering hydraulics to determine:

- The point at which steering movement occurs
- The minimum valve command required for steering movement

In this test, the system gradually actuates the steering system while determining the independent left and right point at which wheel movement occurs for each direction.

Run the Deadzone calibration until the Deadzone value displays for each side a change of less than 0.5 units.

The calibration is run multiple times and a progress indicator displays on the display during each phase of the calibration. After each phase is completed, the display will prompt the user to steer the vehicle in a particular direction.

Pre-calibration

1. Warm up the vehicle. The hydraulic fluid must be at normal operating temperature for deadzone calibration.
2. If you perform the deadzone calibration while the system is cold, repeat the Automated Deadzone calibration again when the system is at operating temperature.
3. Prepare the steering sensor. If the vehicle has:
 - An AutoSense device, drive the vehicle in a straight line for at least one minute.
 - A Potentiometer, first complete the Steering Sensor calibration

Calibration procedure



WARNING – During calibration the vehicle will turn slowly either to the right or to the left. The vehicle may move in an unpredictable manner. To avoid injury, be prepared for vehicle movements.

Note – *To minimize the amount of open area required for the complete calibration, you may reposition the vehicle between the phases of the test.*

During calibration, the vehicle will turn slowly either to the right or to the left. The vehicle may move in an unpredictable manner. To avoid injury, be prepared for vehicle movements.

1. Drive the vehicle to a large field that is without hazards or obstructions. The field should have smooth soil conditions.
2. Begin the *Deadzone Calibration* wizard and then write down the and write down the Right deadzone value and the Left deadzone value. This will be used for comparison purposes after you have run the test.
3. Run the calibration wizard, reading and following all on-screen instructions and taking note of all warning messages.
4. Move the vehicle straight forward in first gear at a maximum operation RPM and at a speed of approximately 1.6 kph (1 mph) and then tap .

- Engage Auto guidance on the display. The calibration will turn the vehicle one direction. When it has completed the first test for a coarse deadzone value, straighten the wheels and push engage again. The system will then turn in the opposite direction to determine the coarse deadzone value for that direction. After this, the system instructs you to repeat this process for the fine values for each side.

If the difference between the deadzone values for the second and third trial:

- Is greater than 0.5 units, repeat the calibration procedure
- Is less than 0.5 units, tap  to complete the calibration

Autopilot Steering Gain calibration

 **WARNING** – The wheels can move abruptly during the Steering Proportional Gain procedure while the Autopilot system tests the hydraulic response to its steering commands. To avoid injury, be prepared for vehicle movement.

Note – *The Steering Sensor Setup and calibration must be performed before you run this procedure. Run this procedure only if the Autopilot system performance is less than satisfactory.*

The Autopilot Steering Gain (or PGain) sets the proportional gain to control steering overshoot and responsiveness. The PGain setting is a compromise between fast steering response and stability. Changes to PGain affect two steering characteristics:

- Slew Time: The amount of time the front wheels take to move from the far left to the far right position and vice versa.
- Overshoot: The percentage by which the front wheels exceed the commanded angle before they settle on the correct value.

By altering these settings, you may correct slight variations in your vehicle due to valve response and tire-to-soil interaction.

- High PGain values decrease the slew time and increases the overshoot. This provides rapid responses, but excessive Pgain can cause the steering to exhibit signs of instability, like a tendency to excessively overshoot and excessive wheel movement when the vehicle is online.
- Low PGain values increase the slew time and decreases the overshoot. This improves the stability, but can introduce significant delays in the steering responses and can cause the vehicle to wander from side to side.

The proportional gain should be increased to the point just before any one of these occur:

- Slew times no longer decrease (low values are preferred).
- Overshoot exceeds 5–8% (depending on the vehicle).
- Wheels noticeably shake during online performance.

Pre-calibration

1. Carry out pre-calibration on a hard, level surface that is free of obstacles.
2. Keep the tractor speed at approximately 1.6 kph (1 mph) during the test.
3. Calibrate the steering gain after calibrating the steering sensor.
4. Warm up the vehicle. The hydraulic fluid must be at normal operating temperature for deadzone calibration.

Calibration



WARNING – During this procedure the wheels will move abruptly. To avoid injury, be prepared for vehicle movements.

Note – To minimize the amount of open area required for completing the calibration, you may reposition the vehicle between the phases of the test.

During this procedure the wheels will move abruptly. To avoid injury, be prepared for vehicle movements.

1. Close fields on the display before performing the calibration.
2. Drive the vehicle to a large field that is without hazards or obstructions. The field should have smooth soil conditions.
3. Run the calibration wizard, reading and following all on-screen instructions and taking note of all warning messages.
4. At the *Autopilot Proportional Gain Adjustment* screen, while moving, turn the wheels to full left or full right and tap the opposite **Test** direction steering command.
 - The wheels will automatically turn to the opposing full turn position.
 - The Slew and Overshoot percentages will be reported After the test has been completed for the turn.
5. After the Slew and Overshoot percentages display on the screen, keep moving and select the opposing test direction to the one you selected in Step 3.
 - The wheels will automatically turn to the opposing full turn position.
 - The Slew and Overshoot percentages will be reported after you have completed the turn.
6. After you have run the slew test in both directions, adjust the P Gain (if required) by an increment of 1 unit in the direction that provides the required vehicle response (higher for a more reactive system, lower for a less reactive system).
7. Repeat the calibration procedure until the appropriate vehicle response is achieved and then tap  to complete the calibration.

Roll / Antenna Compensation

Antenna measurements help the system steer the vehicle more accurately.

Before taking measurements:

1. Park the vehicle on level, solid ground.
2. Make sure the vehicle is straight, with the center line of the body parallel to the wheels.

Follow directions carefully and provide measurements that are within 2.5 cm (1 inch) for the best results after calibration. (Text displays on the screen to help you understand each measurement and process.)

Tap  after you have adjusted all three measurements correctly.

Antenna Height

1. Measure vertically from the ground to the top of the GNSS receiver. Enter the measurement in the appropriate units of the display.
2. Tap .

Antenna-to-Axle Offset

1. Measure horizontally from the center of the fixed axle to the center of the GNSS receiver. Enter the measurement in the appropriate units of the display.
2. If the GNSS receiver is located:
 - In front of the measurement axle, tap **Forward**.
 - Behind the measurement axle, tap **Behind**.

Vehicle Type	Measure from the center of...
MFWD vehicles	the rear axle
4WD articulating vehicles	the front axle
Tracked vehicles	the track assembly
Combines	the front axle
Swather vehicles	the front axle
Sprayer vehicles	the rear axle

3. Tap  when you have entered the correct offset.

Roll Compensation

Note – Before proceeding with Roll Compensation, complete the Manual Override, Automated Deadzone, and Steering Gain calibrations.



Tip – Trimble recommends that you use a highly-repeatable GPS correction mode for roll correction. For best results, use a RTK mode or OmniSTAR® HP signal that has been converged for at least 20 minutes. If you do a roll calibration with less accurate GPS correction modes, repeat the measurements **at least four times** to ensure a more consistent result.

You calibrate Roll Compensation at the *Guidance* screen with an open field and an established AB line.

The results of this procedure must then be entered in the *Roll Compensation* screen. Repeat the calibration process as often as required to achieve the required accuracy.

Pre-calibration

Note – For best results, complete the following procedure using the Drop Flag Method for roll compensation.

1. Remove any implement(s) from the vehicle and drive to a flat, smooth area where you can complete passes of at least 125 m (400 feet) in length.
2. On the display create an open field profile and an active AB line.
3. Run the calibration procedure until the correct response has been achieved.



Calibration procedure

It is recommended that you drop a flag marker from the center of the draw bar hitch for this test to create a point of origin and reference center line.

1. Drive to the created AB line.
2. Engage on the Line for a short distance. When the vehicle's direction stabilizes on the AB line and when the displayed cross track error is below 2 cm (1 inch), stop the vehicle.
3. Mark the vehicle's position by placing a flag below the center of the drawbar pin hole or another repeatable reference point.
4. Continue to drive the vehicle down the AB line and at the end of the line, turn the vehicle around.
5. Re-engage on the AB line, moving in the opposite direction toward the original dropped flag marker.
6. Stop the vehicle on the same point as the original dropped flag marker.

7. Measure the offset distance between the original marker point and the current vehicle location.
8. Go to the *Roll Calibration* screen.
9. Enter the appropriate distance and offset direction resulting from the test.

Vehicle position with reference to flag 1	Cross Track Error says the vehicle is to the ___ of the line	Roll Cal. Calculation Equation	Direction to enter for Offset Direction
Right	Right	Flag Measure - XTE = Roll Cal Value	Right, unless XTE is larger than the flag measurement
Left	Left	Flag Measure - XTE = Roll Cal Value	Left, unless XTE is larger than the flag measurement
Right	Left	Flag Measure + XTE = Roll Cal Value	Right
Left	Right	Flag Measure + XTE = Roll Cal Value	Left

10. Tap .
11. Exit the *Autopilot Calibration* screen so that the offsets can be applied to the NavController II.
12. Go to the *Guidance* screen and then repeat this calibration procedure until the Roll Compensation setting is accurate.
13. Tap .

Performance Settings

Note – Currently the Performance Setting calibration is only available for supported sprayers and swathers.



1. Select the correct performance setting for your sprayer based on the following required responsiveness.

Performance Settings	Explanation
High Accuracy	Creates high accuracy in all conditions. This mode is best for high-accuracy operations at slower speeds, on hard surfaces, tight curves, and side hills.
High Stability	Creates smooth and stable corrections. This mode is best for soft soils, ridges, deep furrows, and high speed operations.

2. Tap .

Advanced settings for the Autopilot system

To view and set the advanced configuration settings of the Autopilot system:

1. At the *Guidance* screen, tap .
2. At the *Settings* screen, tap .
3. Tap **Auto Steer Setup** and then tap **Advanced Settings**.

Setting	Explanation
NMEA Output	Establishes broadcast output protocols for GNSS positioning.
TAP Parameter Wizard	Allows manual entry of specific TAPs and the entry of their required value.
Autopilot Operation	Establishes operational parameters involving guidance aggressiveness, operator warnings, and a selection of steering sensor types.

Autopilot Operation

Operation Category	Explanation
Online Aggressiveness	How quickly the guidance system steers onto an active guidance line.
Operator Alert Timeout	The maximum time interval that the operator can operate without the guidance system asking for operator presence.
End of Row Warning	The distance from the end of the row at which the audible warning sounds to alert the operator of the upcoming event.
Autopilot Steering Sensor	<ul style="list-style-type: none"> Select AutoDense steering sensors or Potentiometer sensors based on the selected Autopilot profile. Set up an AutoSense steering sensor. <p>Note – To calibrate a potentiometer, select <i>Auto Steer Setup / Autopilot Setup / Steering Sensor Calibration</i>.</p>

Autopilot Steering Sensor

Note – The Autopilot Steering Sensor type is set based on the .vdb profile or through the activation of TAP parameters.

Choose the type of Autopilot sensor installed on the vehicle and set up Autosense sensors.



To set up Autosense Steering sensors:

1. Tap **AutoPilot AutoSense Location**.
2. Choose which axle and side of the vehicle the sensor is mounted upon when viewed from the operator's seat.
3. Tap **AutoPilot AutoSense Orientation**.
4. Choose which way the sensor label is facing when viewed from the perspective of looking down on the sensor.
5. Tap .

Note – Potentiometer Steering Sensors are calibrated in *Autopilot Setup*.

Status/Diagnostics for the Autopilot system

To view the system and sensor status settings for the Autopilot system:

1. At the *Guidance* screen, tap .
2. At the *Settings* screen, tap .
3. At the *Vehicle* screen, tap **Status**.
4. At the *Status* screen, tap **Diagnostics**.

At the *Diagnostics* screen you can view the main sensor inputs for the selected vehicle type. The raw and scaled sensor data values will display on each page. Information on the *Diagnostics* screen is updated continuously to allow for real-time evaluation of the connection.

The engage button  displays on screens that require the Autopilot system to be engaged in order to get real-time data from the sensors.

Note – The buttons that display depend on the vehicle loaded from the vehicle database (VDB) or from a restored vehicle configuration.

Diagnostics Category	Explanation
Guidance Details	Displays guidance sensor details: Requested Steering Angle, Heading, PMW values, Corrections, and PPS value.
Steering Details	Displays the raw and scaled values for the Steering Angle sensor.
Manual Override Status	Displays the sensor override voltage as well as the vehicle voltage and status of override setting.
Remote Engage Status	Displays the remote engage voltage, the reported vehicle voltage, and current status of Steering Override setting.
IMU Details	Displays the accelerometer raw and scaled values by axis as well as the gyro axis values of the IMU (Inertial Measurement Unit).
Cross Track Error	Displays the cross track error histogram showing offline distance and average.

Cross Track Error (for advanced users)

The Cross Track Error diagram shows the vehicle's progression and acquisition of an AB guidance line.

After you open a field and set an active AB line, at the *Diagnostics* screen you can:

- View how the vehicle responds to line acquisition commands
- Change settings for better response

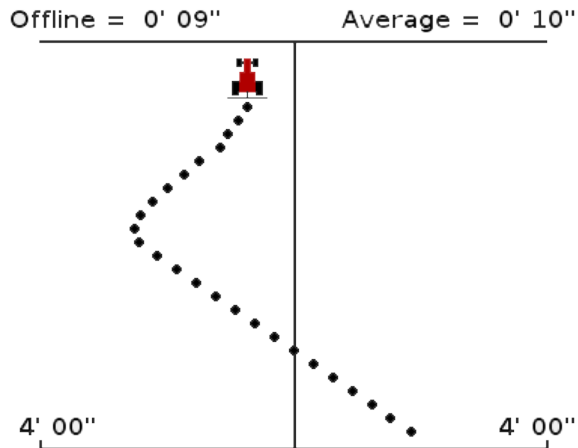

WARNING – During calibration the vehicle will turn slowly either to the right or to the left. The vehicle may move in an unpredictable manner. To avoid injury, be prepared for vehicle movements.

Evaluate vehicle response

During calibration, the vehicle will turn slowly either to the right or to the left. The vehicle may move in an unpredictable manner. To avoid injury, be prepared for vehicle movements.

Note – The field must be open and there must be an active AB line.

1. Drive near the AB line and engage the Autopilot system using the display or Remote Engage buttons.
2. Evaluate the vehicles response using the Offline and the Average distance indicators.
3. Tap the **Nudge** buttons  to nudge the guidance line in either direction.



Note – Nudge shifts the AB line 36 inches (91.4 cm) to either side when the you tap the nudge direction.

The vehicle will begin moving left or right depending on which direction you chose. Verify that the path is free of obstacles and that the vehicle is under full operator awareness before selecting nudge directions.

4. Evaluate the response again using the Offline and the Average distance indicators.
5. Repeat the evaluation as required to understand the responsiveness of the vehicle profile.
6. Tap .

Save or restore vehicle configuration file

To save or restore a completed vehicle configuration file:

1. At the *Guidance* screen, tap .
2. At the *Settings* screen, tap .
3. At the *Vehicle* screen, tap **Auto Steer Setup**.
4. At the *Auto Steer Setup* screen, tap **Save / Restore Configuration**.
5. From the *Save/Restore Configuration* screen, tap the option you need:
 - **Save Vehicle Configuration** to save a vehicle configuration to the external memory or internal memory of the display
 - **Restore Vehicle Configuration** to restore a previously saved configuration file

Note – Configuration files will be recognized if they are copied from an FmX® integrated display and are within the original content folder created by the FmX® integrated display.



 - **Delete Vehicle Configuration** to delete a configuration profiles from external memory or internal memory

A setup wizard will take you through each of the configuration options.

Note – The internal memory of the display can only store a maximum of 10 unique vehicle configurations. External memory options are only available if a USB device is present in the rear port of the display.

Foot or rocker switch setup

To set up the foot or rocker switch:

1. At the *Guidance* screen, tap .
2. At the *Settings* screen, tap .
3. At the *Vehicle* screen, tap **Auto Steer**.
4. At the *Auto Steer* screen, tap **EZ-Pilot Setup**.
5. Tap **EZ-Pilot External Switch**. The *Engage Options* screen displays.
6. Tap **External Switch**.
7. At the *External Switch* screen, tap **Remote Engage** and then tap .

The **External Switch** button now shows Remote Engage and is ready to be used.

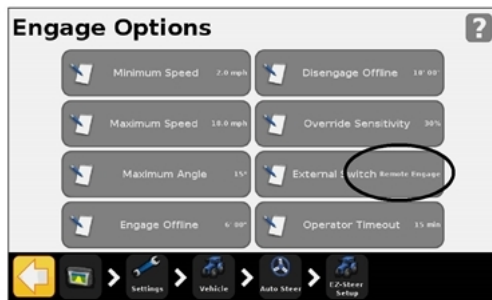

EZ-Remote Joystick custom settings

The joystick has ten LED buttons. Six have preset (standard) functions. For each of the other four buttons, you can assign one of these:



- Map a rock, tree, or weed
- Start or finish a line
- Start or finish an area
- Start or finish an exclusion zone
- Turn coverage on or off
- Camera A or Camera B control
- Show trailing map view
- Show overhead map view
- Zoom
- Show status

At the *EZ-Remote* screen, you can:

- Assign functions to buttons 1-4 on the EZ-Remote joystick
- Adjust the LED brightness of the buttons
- Review the button assignments

Keypad Assignment Wizard

1. Access the *EZ-Remote* screen:

- a. At the *Guidance* screen, tap .
- b. At the *Settings* screen, tap .
- c. At the *System* screen, tap **EZ-Remote**.

Note – *The EZ-Remote option shows in the System menu only if you have an EZ-Remote joystick installed. For more information, see the EZ-Remote Joystick Quick Reference Card.*

2. Tap the first EZ-Remote joystick button you want to program.

3. At the *Choose a Function* screen, tap the function to assign to the joystick button. See the [buttons diagram and table](#).

4. At the *Finished* screen, tap:

- **Choose another button** to repeat Step 1 and Step 2
- **Complete this wizard** to exit the wizard

Joystick buttons



Item	Button	Explanation
①	Customized	Can be customized to control a function. See EZ-Remote Joystick custom settings, 86 .
②	Customized	Can be customized to control a function. See EZ-Remote Joystick custom settings, 86 .
③	Engage	Engage auto steering.
④	Customized	Can be customized to control a function. See EZ-Remote Joystick custom settings, 86 .
⑤	Customized	Can be customized to control a function. See EZ-Remote Joystick custom settings, 86 .

⑥	Left	Nudge the guidance line to the left at the <i>Guidance</i> screen.
⑦	Right	Nudge the guidance line to the right at the <i>Guidance</i> screen.
⑧	Up and down	<i>Not supported.</i>
⑨	Trigger	On the back. <i>Not supported.</i>

LED Brightness

At this screen, adjust the brightness of the LED buttons on the joystick. Enter a number between 0-100.

Keypad Assignments

The *EZ-Remote Keypad Assignments* screen shows the functions that have been assigned to the four programmable buttons.

Implement application controller setup

In this chapter:



Implement application controller setup	.92
Prescriptions	93
HARDI 5500 / 6500 controller setup	94
Raven controller setup	97
Rawson controller setup	99
Amazone controller setup	102
LH 5000 controller setup	105
Vaderstad controller setup	108
Bogballe controller setup	111
Check communication status	113

You can configure the CFX-750 display to use an implement application controller, such as the Field-IQ crop input control system.

Implement application controller setup

To setup an implement application controller (such as the Field-IQ crop input control system), you start at the *Implement* screen.

To access the *Implement* screen:

1. From the *Guidance* screen, tap .
2. From the *Settings* screen, tap .

At the *Implement* screen are two options:

- **Advanced:** Displays only after you have set up your controller using the Initial Setup option
 - **Initial Setup:** For initial setup of implement
3. Tap **Initial Setup**. The *Controller Type* screen displays.
 4. Select the controller that you are using.

Note – To access all of the available *Controller Type* options (apart from *None* and *Field-IQ*) you must have a VRA unlock code. To obtain a VRA unlock code, contact your Trimble reseller.

- HARDI 5500/6500 (see [HARDI 5500 / 6500 controller setup, 94](#))
- Raven (see [Raven controller setup, 97](#))
- Rawson (see [Rawson controller setup, 99](#))
- Amazone (see [Amazone controller setup, 102](#))
- LH5000 (see [LH 5000 controller setup, 105](#))
- Vaderstad (see [Vaderstad controller setup, 108](#))
- Bogballe (see [Bogballe controller setup, 111](#))

Note – When you change the controller type, any open field will close.

Prescriptions

The CFX-750 display can use a prescription file to determine the rate of application in different areas of the field.

The prescription file consists of three separate ESRI file types: .shp, .dbf and .shx. Each of these file types contain different information used by the display.

You must load a prescription from the USB drive to the internal memory of the CFX-750 display. The display cannot read prescriptions directly from a USB drive.

Load a prescription

To load a prescription from a USB drive:

1. Copy the prescription file from your computer to the *AgGPS/Prescriptions* folder on your USB drive.

For more information, see [USB drive data transfer, 183](#).

Note – If you do not have an *AgGPS®* directory on your USB, create one by exporting field data to the USB.

2. Insert the USB drive into the USB socket, and then copy the prescription file to the display's internal memory.
3. From the *Guidance* screen, create a new field or select an existing field by tapping .

The CFX-750 display searches internally for prescription files. After you define or select a field, the *Available Prescriptions List* screen displays.

4. Tap the prescription file you want and tap . The *Prescription Parameters* screen displays.
5. Configure each of the parameters for the prescription you chose.

Setting	Explanation
Rate Column	 CAUTION – For the system to work correctly, you must select the correct Rate Column setting. If you do not, the applied rate will be incorrect.
Rate Units	Units of the rate information
Scale Factor	Select the scale factor for whatever units are used in the prescription file.
Rate Outside Prescription	Select the target rate for application when you are outside the area that is covered by the prescription file.

HARDI 5500 / 6500 controller setup

Note – For the HARDI 5500 / 6500 controller to work correctly with the CFX-750 display, you must install firmware version 6.00 or greater on the HARDI controller and connect a JOBCOM control box.

1. After you select the HARDI 5500 or HARDI 6500 as your controller, the *Output Port* screen displays.
2. Choose the port you want to use.
3. Set up the display to output NMEA messages. (See NMEA Output at [Advanced display settings, 192.](#))

Note – Do not configure the display to output NMEA messages on the same port that your controller is connected to.

4. On the HARDI 5500/HARDI 6500 controller, go to the *Settings* screen.
5. Change Remote to Enable.

For more information on setting up the HARDI 5500/HARDI 6500 controller, refer to the HARDI instruction manual.

Advanced

Use the *Advanced* option in the *Implement* screen to set up:

- [Boom Setup](#)
- [Swath Control](#)
- [Rate Control](#)
- [Off When Stopped](#)
- [Rate Snapping](#)

Boom Setup

The boom setup on the CFX-750 display must match the setup on the HARDI controller. If the boom setup differs between the display and the HARDI controller, a warning message displays.

Setting	Explanation
Implement width	Enter a width between 1' 00" - 328' 01" (0.30 - 99.99 m).
Fence Nozzles	Enter the locations of any fence nozzles.
Number of sections	Enter a number between 1 - 10.

Swath Control

Setting	Explanation
Boom control	Enter a width between 1' 00" - 328' 01" (0.30 - 99.99 m).
Coverage switching overlap	The amount of boom switching overlap allowed before the section will be switched by the system. Enter a value between 1 - 99%.
Boundary switching overlap	The amount of overlap on a boundary before the boom section is switched off. Enter a value between 1 - 99%.
On/Off valve latency	Tune the section switching to allow for hardware delays. Enter a time between 0.0 - 10.0 seconds.
Intentional overlap	Set a distance to be overlapped when moving to an unsprayed area or out of a sprayed area. Enter a distance between 0' 00" - 32' 10" (0.00 - 10.00 m).

Rate control

Setting	Explanation
On	Application rates are sent from a prescription loaded in the display or the target rate manually configured on the display.
Off	The target rate must be set on the HARDI controller. The CFX-750 display does not send target rates to the controller. This is the default setting.

Note – When sending a target rate to the HARDI 5500 controller that is higher than 99.9, the display rounds to the nearest whole number. For example, 0-99.9 is not rounded. 101.4 is rounded to 101.

Off When Stopped

You can use this option to control whether the system allows the vehicle to continue operating when it is not moving.

If the vehicle is a clutch-operated planter, tap **No** so you can continue planting even when stopped.

Rate Snapping

Due to pump constraints, liquid flow is generally inconsistent. To control how these inconsistencies show up on your display, turn rate snapping on or off.

Setting	Explanation
On	Matches the applied rate to the target rate when within 10% of the value.
Off	Shows all fluctuations in the actual applied rate.

Raven controller setup

When using the Raven SCS 400 and 600 series controller with the CFX-750 display, keep in mind:

- The CFX-750 display cannot control the status of the Raven controller master or boom switches. This means that the operator must remain in complete control of the sprayer at all times.
- The CFX-750 display cannot automatically turn off the sprayer when going outside headlands, across exclusion zones, or previously sprayed areas.
- The sprayer may not always switch off completely when the CFX-750 display sends a zero rate. This means the operator may need to manually turn off the master switch to ensure that spray is not applied.
- The only time the CFX-750 display sends a zero rate is when the sprayer is outside a prescription boundary and the "Rate outside polygon" option is zero.

Note – *The operator must ensure that the master switch is off when there is no field open so that no spray is accidentally applied to areas that shouldn't be sprayed, for example, roads, paths, and neighboring fields.*

1. After you select Raven as your controller, the *Output Port* screen displays.
2. Choose the port you want to configure.

Note – *Do not configure the display to output NMEA messages on the same port that your controller is connected to.*

3. On the Raven controller, configure the Data Menu settings.

Setting	Set to...
Baud or Baud Rate	9600
GNSS	Inac
DLOG or Data Log	On
TRIG or Data Log Trigger Value	1
UNIT or Data Log Trigger Units	sec

Note – *At the GNSS group, if 'Send time', 'Time acknowledge' or 'Close file' displays, change them to GNSS Inac. Otherwise, the DLOG or DATA LOG option will not display.*

For more information on configuring and calibrating the Raven controller, refer to the Raven instruction manual.

Advanced

Use the Advanced option in the *Implement* screen to configure:

- [Boom Setup](#)
- [Target Rate](#)
- [Rate Snapping](#)

Boom Setup

Setting	Explanation
Implement width	Enter a width between 1' 00" - 328' 01" (0.30 - 99.99 m).
Number of sections	Enter a number between 1 - 10.

Target Rate

Set the target application rate that will be sent to the Raven controller. Enter a rate between 0.0 - 11000.0.

Rate Snapping

Due to pump constraints, liquid flow is generally inconsistent. To control how these inconsistencies display on the screen, turn rate snapping on or off.

Setting	Explanation
On	Matches the applied rate to the target rate when within 10% of the value.
Off	Shows all fluctuations in the actual applied rate.

Rawson controller setup

1. After you select Rawson as your controller, a warning message displays. Read the message carefully, and then tap to  continue.
2. At the *Output Port* screen, choose the port you want to configure.
3. Change the Output Port to COM or AUX to match the port on the display that the controller is connected to.
4. On the Rawson controller:
 - a. Verify the default target rate and step size and then enter these values into the CFX-750 display. To learn how to change these settings on the display, see [Advanced](#).
 - b. Set the baud rate to 9600.

To enable the CFX-750 display to change the rates on the controller, you must also set the Rawson controller to GNSS mode:

1. Turn the Rawson controller on.
2. Press the MODE button twice.
3. Press the SET button to switch the controller between GNSS and non-GNSS modes.

If you do not set the Rawson controller to use GNSS mode, the CFX-750 display will only log the rates being used.

For more information on configuring the Rawson controller, refer to the *ACCU-RATE Controller 9.2A User Guide*.

Advanced

Use the Advanced option in the *Implement* screen to configure:

- [Boom Setup](#)
- [Swath Control](#)
- [Target Rate](#)
- [Default Rate](#)
- [Step Size](#)
- [Rate Snapping](#)

Boom Setup

Setting	Explanation
Implement width	Enter a width between 1' 00" - 328' 01" (0.30 - 99.99 m).
Number of sections	Enter a number between 1 - 10.

Swath Control

Setting	Explanation
Boom control	Enter a width between 1' 00" - 328' 01" (0.30 - 99.99 m).
Coverage switching overlap	The amount of boom switching overlap allowed before the section will be switched by the system. Enter a value between 1 - 99%.
Boundary switching overlap	The amount of overlap on a boundary before the boom section is switched off. Enter a value between 1 - 99%.
On/Off valve latency	Tune the section switching to allow for hardware delays. Enter a time between 0.0 - 10.0 seconds.
Intentional overlap	Set a distance to be overlapped when moving to an unsprayed area or out of a sprayed area. Enter a distance between 0' 00" - 32' 10" (0.00 - 10.00 m).

Target Rate

Set the target application rate that will be sent to the Rawson controller. Enter a rate between 0.0 - 11000.0.

Alternatively, you can load a prescription so the CFX-750 display will automatically send target rates to the Rawson controller.

Note – When the CFX-750 display is sending target rates to the Rawson controller, the Rawson controller will only display the Target Rate screen. To change or view any other screen on the Rawson controller, you must unplug the CFX-750 display cable.

Note – When using a prescription with the Rawson controller, the target rates in the prescription must match the step sizes in the Rawson controller. For example, if the default is 25000 and the step size is 4%, then the target rate values accepted by the Rawson controller are 26000, 27000, 28000...40000. Otherwise, the Rawson controller may not be able to apply the correct rate.

Default Rate

On the CFX-750 display, set the same target rate that displays on the Rawson controller when you first power up it up. Enter a number between 0 - 9999000.

Step Size

The step size increases or decreases the actual applied rate by the percentage that you select. You can choose from:

- 2%
- 4%
- 6 2/3%

Rate Snapping

Due to pump constraints, liquid flow is generally inconsistent. To control how these inconsistencies show up on your display, turn rate snapping on or off.

Setting	Explanation
On	Matches the actual applied rate to the target rate when within 10% of the value.
Off	Shows all fluctuations in the actual applied rate.

Amazone controller setup

1. After you select Amazone as your controller, the *Output Port* screen displays.
2. Choose the port you want to configure.

Note – Do not configure the display to output NMEA messages on the same port that your controller is connected to.

1. On the Amazone controller, go to the *Settings* menu.
2. Change Remote to Enable.

For more information on setting up the Amazone controller, refer to the Amazone instruction manual.

Advanced

Use the *Advanced* option in the *Implement* screen to set up:

- [Boom Setup](#)
- [Swath Control](#)
- [Rate Control](#)
- [Target Rate](#)
- [Turn Off Rate on Overlap](#)
- [Rate Snapping](#)

Boom Setup

The boom setup on the CFX-750 display must match the setup on the Amazone controller. If the boom setup differs between the display and the Amazone controller, a warning message displays.

Setting	Explanation
Implement width	Enter a width between 1' 00" - 328' 01" (0.30 - 99.99 m).
Fence Nozzles	Enter the locations of any fence nozzles.
Number of sections	Enter a number between 1 - 10.

Swath Control

Setting	Explanation
Boom control	Enter a width between 1' 00" - 328' 01" (0.30 - 99.99 m).
Coverage switching overlap	The amount of boom switching overlap allowed before the section will be switched by the system. Enter a value between 1 - 99%.
Boundary switching overlap	The amount of overlap on a boundary before the boom section is switched off. Enter a value between 1 - 99%.
On/Off valve latency	Tune the section switching to allow for hardware delays. Enter a time between 0.0 - 10.0 seconds.
Intentional overlap	Set a distance to be overlapped when moving to an unsprayed area or out of a sprayed area. Enter a distance between 0' 00" - 32' 10" (0.00 - 10.00 m).

Rate control

Setting	Explanation
On	Application rates are sent from a prescription loaded in the display or the target rate manually configured on the display.
Off	The target rate must be set on the Amazone controller. The CFX-750 display does not send target rates to the controller. This is the default setting.

Note – When sending a target rate to the Amazone controller that is higher than 99.9, the display rounds to the nearest whole number. For example, 0-99.9 is not rounded. 101.4 is rounded to 101.

Target Rate

Set the target application rate that will be sent to the Amazone controller. Enter a rate between 0.0 - 11000.0.

Turn Off Rate on Overlap

Setting	Explanation
Yes	Does not spray over an area that has been previously sprayed.
No	Sprays over an area that has been previously sprayed.

Rate Snapping

Due to pump constraints, liquid flow is generally inconsistent. To control how these inconsistencies show up on your display, turn rate snapping on or off.

Setting	Explanation
On	Matches the applied rate to the target rate when within 10% of the value.
Off	Shows all fluctuations in the actual applied rate.

LH 5000 controller setup

1. After you select LH 5000 as your controller, the *Output Port* screen displays.
2. Choose the port you want to configure.
3. Make sure the Output Port matches the port on the display that the controller is connected to (COM or AUX).
4. Do not configure the display to output NMEA messages on the same port that your controller is connected to.

For more information on configuring the LH 5000 controller, refer to the LH 5000 instruction manual.

Advanced

Use the *Advanced* option in the *Implement* screen to set up:

- [Boom Setup](#)
- [Swath Control](#)
- [Rate Control](#)
- [Target Rate](#)
- [Turn Off Rate on Overlap](#)
- [Rate Snapping](#)

Boom Setup

The boom setup on the display must match the setup on the LH 5000 controller. If the boom setup on the display is different from that on the LH 5000 controller, a warning message displays.

Setting	Explanation
Implement width	Enter a width between 1' 00" - 328' 01" (0.30 - 99.99 m).
Fence Nozzles	Enter the locations of any fence nozzles.
Number of sections	Enter a number between 1 - 10.

Swath Control

Setting	Explanation
Boom control	Enter a width between 1' 00" - 328' 01" (0.30 - 99.99 m).

Setting	Explanation
Coverage switching overlap	The amount of boom switching overlap allowed before the section will be switched by the system. Enter a value between 1 - 99%.
Boundary switching overlap	The amount of overlap on a boundary before the boom section is switched off. Enter a value between 1 - 99%.
On/Off valve latency	Tune the section switching to allow for hardware delays. Enter a time between 0.0 - 10.0 seconds.
Intentional overlap	Distance to be overlapped when moving to an unsprayed area or out of a sprayed area. Enter a distance between 0' 00" - 32' 10" (0.00 - 10.00 m).

Rate control

Setting	Explanation
On	Application rates are sent from a prescription loaded in the display or the target rate manually configured on the display.
Off	The target rate must be set on the LH 5000 controller. The CFX-750 display does not send target rates to the controller. This is the default setting.

When sending a target rate to the LH 5000 controller that is higher than 99.9, the display rounds to the nearest whole number. For example, 0-99.9 is not rounded. 101.4 is rounded to 101.

Target Rate

Set the target application rate that will be sent to the LH 5000 controller. Enter a rate between 0.0 - 11000.0.

Turn Off Rate on Overlap

Setting	Explanation
Yes	Does not spray over an area that has been previously sprayed.
No	Sprays over an area that has been previously sprayed.

Rate Snapping

Due to pump constraints, liquid flow is generally inconsistent. To control how these inconsistencies show up on your display, turn rate snapping on or off.

Setting	Explanation
On	Matches the applied rate to the target rate when within 10% of the value.
Off	Shows all fluctuations in the actual applied rate.

Vaderstad controller setup

1. After you select Vaderstad as your controller, the *Output Port* screen displays.
2. Choose the port you want to configure.

Note – Do not configure the display to output NMEA messages on the same port that your controller is connected to.
3. At the *Device Type* screen, select the type of implement you are using:
 - Sprayer
 - Planter/Seeder
 - Fertilizer/Spreader
4. On the Vaderstad controller, go to the setup screen. Set GNSS to No.

Advanced

Use the Advanced option at the *Implement* screen to set up:

- [Boom Setup](#)
- [Swath Control](#)
- [Rate Control](#)
- [Target Rate](#)
- [Single section boom switching](#)
- [Rate Snapping](#)

Boom Setup

The boom setup on the CFX-750 display must match the setup on the LH 5000 controller. If the boom setup differs between the display and the Vaderstad controller, a warning message displays.

Setting	Explanation
Implement width	Enter a width between 1' 00" - 328' 01" (0.30 - 99.99 m).
Fence Nozzles	Enter the locations of any fence nozzles.
Number of sections	Enter a number between 1 - 10.

Swath Control

Setting	Explanation
Boom control	Enter a width between 1' 00" - 328' 01" (0.30 - 99.99 m).
Coverage switching overlap	The amount of boom switching overlap allowed before the section will be switched by the system. Enter a value between 1 - 99%.
Boundary switching overlap	The amount of overlap on a boundary before the boom section is switched off. Enter a value between 1 - 99%.
On/Off valve latency	Tune the section switching to allow for hardware delays. Enter a time between 0.0 - 10.0 seconds.
Intentional overlap	Set a distance to be overlapped when moving to an unsprayed area or out of a sprayed area. Enter a distance between 0' 00" - 32' 10" (0.00 - 10.00 m).

Rate control

Setting	Explanation
On	Application rates are sent from a prescription loaded in the display or the target rate manually configured on the display.
Off	The target rate must be set on the LH 5000 controller. The CFX-750 display does not send target rates to the controller. This is the default setting.

When sending a target rate to the LH 5000 controller that is higher than 99.9, the display rounds to the nearest whole number. For example, 0-99.9 is not rounded. 101.4 is rounded to 101.

Target Rate

Set the target application rate that will be sent to the LH 5000 controller. Enter a rate between 0.0 - 11000.0.

Single section boom switching

Use this to turn off the implement in areas that have already been applied.

This setting can only turn the entire boom on and off. It does not support individual sections.

- Tap **Yes** to avoid spraying an area that has previously been sprayed.
- Tap **No** to spray an area that has previously been sprayed.

Rate Snapping

Due to pump constraints, liquid flow is generally inconsistent. To control how these inconsistencies show up on your display, turn rate snapping on or off.

Setting	Explanation
On	Matches the applied rate to the target rate when within 10% of the value.
Off	Shows all fluctuations in the actual applied rate.

Bogballe controller setup

The CFX-750 display is compatible with Bogballe Calibrator ZURF, ICON, and UNIQ controllers.

1. After you select Bogballe as your controller, the *Output Port* screen displays.
2. Choose the port you want to configure.

Note – Do not configure the display to output NMEA messages on the same port that your controller is connected to.

3. On the Bogballe controller, press Return / Return / Fertil.-Distrib / Select Type / Bogballe E/EX / Accept

For more information on setting up the Bogballe controller, refer to the Bogballe instruction manual.

Advanced

Use the Advanced option at the *Implement* screen to configure:

- [Boom Setup](#)
- [Swath Control](#)
- [Rate Control](#)
- [Target Rate](#)
- [Single Section Boom Switching](#)

Boom Setup

Note – The boom setup on the CFX-750 display must match the setup on the LH 5000 controller. If the boom setup differs between the display and the LH 5000 controller, a warning message displays.

Setting	Explanation
Implement width	Enter a width between 1' 00" - 328' 01" (0.30 - 99.99 m).
Fence Nozzles	Enter the locations of any fence nozzles.
Number of sections	Enter a number between 1 - 10.

Swath Control

Setting	Explanation
Boom control	Enter a width between 1' 00" - 328' 01" (0.30 - 99.99 m).
Coverage switching overlap	The amount of boom switching overlap allowed before the section will be switched by the system. Enter a value between 1 - 99%.
Boundary switching overlap	The amount of overlap on a boundary before the boom section is switched off. Enter a value between 1 - 99%.
On/Off valve latency	Tune the section switching to allow for hardware delays. Enter a time between 0.0 - 10.0 seconds.
Intentional overlap	Set a distance to be overlapped when moving to an unsprayed area or out of a sprayed area. Enter a distance between 0' 00" - 32' 10" (0.00 - 10.00 m).

Rate control

Setting	Explanation
On	Application rates are sent from a prescription loaded in the display or the target rate manually configured on the display.
Off	The target rate must be set on the LH 5000 controller. The CFX-750 display does not send target rates to the controller. This is the default setting.

Note – When sending a target rate to the LH 5000 controller that is higher than 99.9, the display rounds to the nearest whole number. For example, 0-99.9 is not rounded. 101.4 is rounded to 101.

Target Rate

Set the target application rate that will be sent to the LH 5000 controller. Enter a rate between 0.0 - 11000.0.

Single section boom switching

Use this to turn off the implement in areas that have already been applied.

Note – This setting can only turn the entire boom on and off. It does not support individual sections.

- To avoid spraying an area that has previously been sprayed, tap **Yes**.
- To spray an area that has previously been sprayed, tap **No**.

Check communication status

To check that the CFX-750 display and your implement controller are communicating correctly, access the *VR Controller Status* screen.

1. At the *Settings* screen, tap .
2. At the *Vehicle* screen, tap **Status**.
3. At the *Status* screen, tap **VR Controller Status**.
4. Check that the status displays as Connected.
5. If the status display shows as Not Connected, verify that the controller cable is securely connected to the display. If the cable is secure, verify that the display and the controller are configured correctly.

Field-IQ crop input control setup

In this chapter:

Overview of Field-IQ	116
Field-IQ crop input installation	118
Field-IQ setup for implements	119
Material setup	123
Row Crop Seed setup	124
Control setup for a location	127
System Status	139
Hydraulics Test	139
Calibrations	140

With the Field-IQ input control system, the CFX-750 display can:

- Control:
 - Planters
 - Sprayers
 - Liquid strip-till toolbars
 - Spinner spreaders
 - Seed or liquid fertilizer rates using prescriptions and Rawson® drives
- Perform automatic section control using the Tru Count Air Clutch® or Tru Count LiquiBlock™ valves

Overview of Field-IQ

The different functions of the Field-IQ system that you can configure and control are:

Function	Explanation
Planter	<ul style="list-style-type: none"> Seed section control of up to 48 individual rows (Field-IQ section control module(s) needed using the Tru Count Air Clutch. Seed rate control using up to 4 Rawson drives to change seed population Note – Requires Field-IQ Rawson Control Module(s). Seed rate control using up to 4 PWM drives to change seed population. Liquid fertilizer control of up to 48 individual liquid nozzles Note – Requires Field-IQ section control module(s) using Tru Count LiquiBlock valves.
Sprayer	<ul style="list-style-type: none"> Liquid section control of up to 48 individual rows Note – Requires Field-IQ section control module(s) using existing boom shutoff valves or Tru Count LiquiBlock valves. Connects to spraying systems that are configured with servo, pump servo, PWM, bypass, dump and master valves.
Strip-till (liquid)	<ul style="list-style-type: none"> Liquid section control of up to 48 individual spray nozzles Note – Requires Field-IQ Section Control Module(s) needed) using Tru Count LiquiBlock valves. Liquid rate control using up to 2 Rawson drives connected to fixed displacement pumps, such as CDS-John Blue piston pumps, to change liquid rate Note – Requires Field-IQ Rawson Control Module(s). Liquid rate control using either a PWM or Servo control valve and flow meter.
Spreading	<ul style="list-style-type: none"> Spreading rate control using a Rawson Drive Note – Requires Field-IQ Rawson Control Module(s). Spreading rate control using either a PWM or Servo control valve and application rate sensor.

Definitions

Setting	Explanation
Section	A number of rows or spray nozzles that are controlled by the Tru Count Air Clutch or Tru Count LiquiBlock valves, or boom valves. A section can have either a single row/nozzle or multiple rows/nozzles depending on how the system is set up.
Row	The individual row unit that material comes from on the implement. This can be controlled individually as a single row section, or as a group with other rows in a multiple row section.
Master Switch Box (MSB)	Master on/off/jump start, auto/manual switch, rate selection, and increment/decrement switch. See Field-IQ master switch box, 235 .
12 Section Switch Box (12SSB)	Required for section control. Manually control sections/rows. See Field-IQ master switch box, 235 .
Section Control Module (SCM)	Controls 12 sections/rows per module with up to 4 modules (48 module sections / rows).
Rate and Section Control Module (RSCM)	Controls 12 sections and application rate for spraying, spreading and NH3.
Rawson Control Module (RWCM)	Controls 1 Rawson variable rate drive per module with up to 4 modules.
Implement Switch	Included in planter, NH3 and strip-till platform kits.

Units of measure

Setting	Type of measure	Symbol	Explanation
Seed	Metric	kS/ha	Thousands of seeds per hectare
	US/Imperial	kS/a	Thousands of seeds per acre
Granular seed	Metric	kg/ha	Kilograms of seed per hectare
	US/Imperial	lbs/a	Pounds of seed per acre

Setting	Type of measure	Symbol	Explanation
Liquid application	Metric	L/ha	Liters per hectare
	US/Imperial	Gal/a	Gallons per acre
Granular fertilizer	Metric	kg/ha	Kilograms of fertilizer per hectare
	US/Imperial	lbs/a	Pounds of fertilizer per acre
Granular seed	Metric	kg/ha	Kilograms of seed per hectare
	US/Imperial	lbs/a	Pounds of seed per acre
Liquid application	Metric	L/ha	Liters per hectare
	US/Imperial	Gal/a	Gallons per acre
Granular fertilizer	Metric	kg/ha	Kilograms of fertilizer per hectare
	US/Imperial	lbs/a	Pounds of fertilizer per acre
NH3	Metric	kg/NH3	Kilograms of anhydrous per hectare
	US/Imperial	lbs/NH3	Pounds of anhydrous per acre
	Metric	kg/N	Kilograms of nitrogen per hectare
	US/Imperial	lbs/N	Pounds of nitrogen per acre

Field-IQ crop input installation



WARNING – Anhydrous ammonia (NH₃) can cause severe burning, blindness, or death. NH₃ is an irritant and corrosive to the skin, eyes, respiratory tract and mucous membranes, and is dangerous if not handled properly. It may cause severe burns to the eyes, lungs, and skin. Skin, and respiratory-related diseases could be aggravated by exposure. It is recommended that protective gloves, boots, slicker and/or pants and jacket, and chemical-splash goggles that are impervious to anhydrous ammonia are worn at all times. See [Safety Information, 17](#).

For information on installing the Field-IQ crop input control system on your implement, refer to:

- *Field-IQ Platform Installation Instructions*
- *Tru Count Air Clutch Installation Instructions*
- *Rawson Installation Instructions*



For the latest versions of these documents, visit www.trimble.com.

Field-IQ setup for implements



To set up an implement for Field-IQ, you will make changes to:

- Implement and controller type (see [Implement and controller type, 119](#))
- Operation and layout (see [Operation and layout setup, 119](#))
- Implement measurement (see [Implement measurements, 120](#))
- Implement switches (see [Implement switches, 122](#))
- Material set up (see [Material setup, 123](#))

Implement and controller type

1. At the *Guidance* screen, tap .
2. At the *Settings* screen, tap .
3. At the *Implement* screen, tap **Initial Setup**.

Note – When you are setting the system up for the first time, the **Initial Setup** button is the only button that displays. However, if you have previously installed the Field-IQ system, more options will display.

4. At the *Controller Type* screen, tap **Field-IQ** and then tap .
5. The *Summary* screen displays, listing all the Field-IQ components and their serial numbers detected by the display. To continue, tap .

Operation and layout setup

1. At the *Implement Type* screen, tap **Implement Operation**.
2. At the *Implement Operation* screen, tap the required operation and then tap .
3. At the *Implement Type* screen, tap **Implement Layout**. Tap the type of operation you will be performing.

Note – The options that you can select depend on the operation you selected.

Implement Operation	Layout Options
Spreading	<ul style="list-style-type: none"> Pull-type spreader Spreader truck
Spraying	<ul style="list-style-type: none"> Front sprayer Rear sprayer Pull-type sprayer
Planting	Standard planting
Tillage	Tilling

4. After you select both the Implement Operation and the Implement Layout, tap .

Implement measurements

- At the *Implement Measurements* screen, tap each option in sequence to complete the measurements for your implement.
- After you enter the required measurements in a settings screen, tap  to return to the *Implement Measurement* screen and select the next option.



Note – For the best performance, physically measure your implement and enter accurate values for each setting.

After you enter all the required measurements, tap .

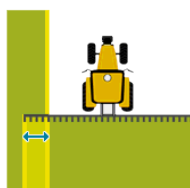
Setting	Explanation
Number of Rows	Number of rows covered by the implement.
Row Spacing	Spacing between the rows.
Overlap / Skip	<p>The amount of overlap or skip between swaths.</p> <p>Overlap is a intentional overlap between swaths to avoid any skips.</p> <p>Skip is a intentional skip between swaths.</p> <p>This setting is used with the Implement Width to set the spacing of the swaths in the field.</p>

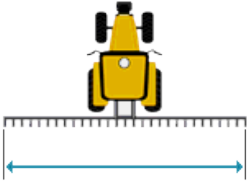
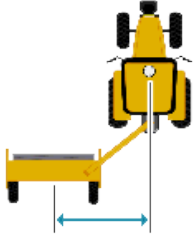
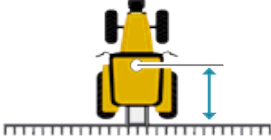
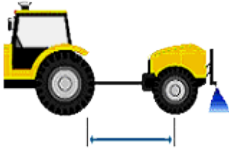

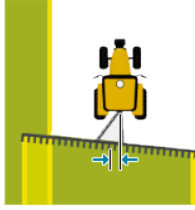
Setting	Explanation
<p data-bbox="256 344 472 376">Implement Width</p> 	<p data-bbox="600 344 1326 412">The width of the implement's application coverage area. This measurement is used for logging coverage.</p> <ul data-bbox="620 427 1342 573" style="list-style-type: none"> • For planters, width is calculated using the number of rows and the row spacing. • For swathers, width is calculated by the implement width and the overlap/skip setting.
<p data-bbox="256 672 472 703">Left / Right Offset</p> 	<p data-bbox="600 672 1355 736">Used for implements that are offset to the left or right from the vehicle center line.</p> <p data-bbox="600 757 1353 822">This is measured from the center of the vehicle to the center of the implement.</p> <p data-bbox="600 842 1270 907">The measurement adjusts the tractor's path so that the implement is centered on the line.</p>
<p data-bbox="256 1048 520 1079">Forward / Back Offset</p> 	<p data-bbox="600 1048 1326 1113">The distance from the vehicle to the implement / application point.</p> <p data-bbox="600 1133 1369 1198">The offset is measured from the fixed axle of the vehicle to the point on the implement where coverage logging will be mapped.</p> <p data-bbox="600 1218 1066 1249">The fixed axle depends on vehicle type:</p> <ul data-bbox="620 1270 1374 1384" style="list-style-type: none"> • Front steering tractors and self-propelled sprayers: Rear axle • 4 x 4 articulated tractors: Front axle • Tracked tractors: Center of tracks
<p data-bbox="256 1406 555 1471">Hitch to Ground Contact Point</p> 	<p data-bbox="600 1406 1331 1471">Distance from the hitch to where the implement pivots on its ground contact point.</p> <p data-bbox="600 1491 1337 1556">Measured from the tractor's hitch pin to the soil engagement point that the implement rotates about.</p> <p data-bbox="600 1576 1374 1641">For planters, this is typically the seeding units or the midpoint of several rows of tools.</p>

Setting	Explanation
Implement Draft 	<p>Distance that the implement drifts away from the center line of the vehicle.</p> <p>This setting is used to adjust the implement back on line if the implement is physically drifting offline in the field.</p> <p>This setting is similar to the Left/Right Offset.</p>
Implement Mount Type  	<p>The type of mount required:</p> <ul style="list-style-type: none"> • Hitched/3pt: Implement is mounted on a 3-point hitch, meaning the implement rotates around the vehicle. <i>Note – When the vehicle makes a slight correction, you will instantly see a change in the implement's location.</i> • Drawbar: The implement is attached by a drawbar, meaning the implement rotates around its ground contact point. <i>Note – When the vehicle makes a correction, you may not see a change in the implement until a certain distance has been traveled</i>

Implement switches

1. At the *Implement Switches* screen, tap **Implement Lift Setup**.
2. At the *Implement Lift Setup* screen, tap **Implement Lift Enable**.
3. Tap **Yes** in the *Implement Lift Enable* screen and then tap .

4. You are returned to the *Implement Lift Setup* screen to complete the settings.

Setting	Explanation
Number of Switches	Number of implement switches connected to the Field-IQ system
Min Changed Switches	<p>Number of switch changes required to show the implement in a lifted state.</p> <p>For example, if three switches are hooked up to the Field-IQ system and this setting is set to two, the system must see two switches in the lifted position before the implement displays as lifted on the display.</p>

5. Tap  when done.

Material setup

1. At the *Implement* screen, tap **Material Setup**.
2. At the *Material Setup* screen, tap **New Material**.
3. At the *Material Management* screen, tap **Material Type**.
4. At the *Material Type* screen, select the material type.
 - Row Crop Seed (see [Row Crop Seed setup, 124](#))
 - Liquid
 - Granular Seed
 - Granular Fertilizer
 - Anhydrous
5. Tap  to return to the *Material Management* screen. Here you can set up the material you chose at the *Material Type* screen.

Row Crop Seed setup

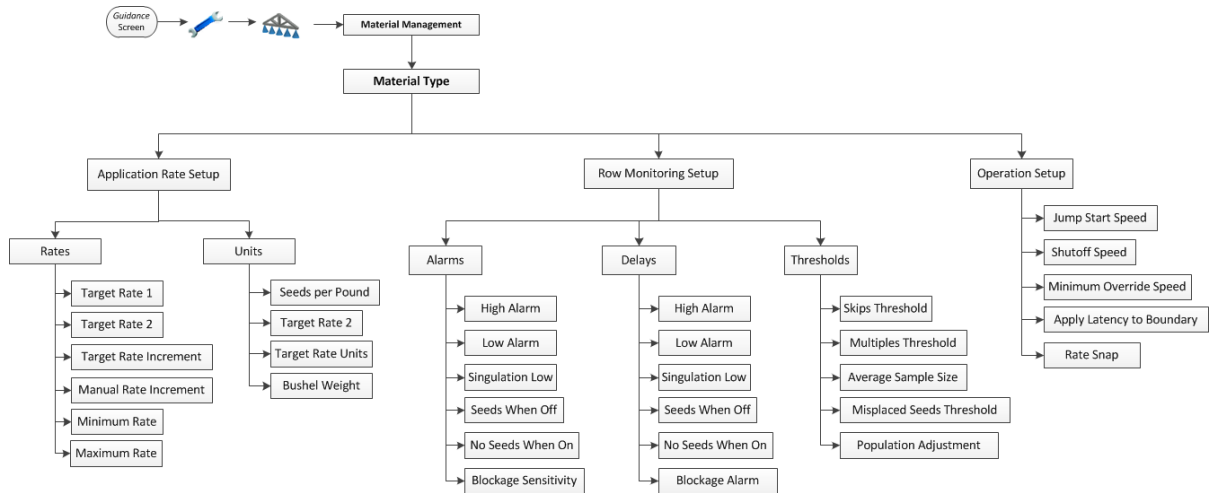

1. At the *Material Management* screen, tap **Material Name**.
2. At the *Material Name* screen, enter a name for the material and then tap .
3. At the *Material Management* screen, tap **Application Rate Setup**.
4. At the *Application Rate Setup* screen, tap **Rates**.
 - a. Rates

Rate Setting	Explanation
Target Rate 1	Preset rate for position 1 on the rate switch.
Target Rate 2	Preset rate for position 2 on the rate switch.
Target Rate Increment	Rate increase / decrease for Target Rate 1 or 2, when the Rate Adjustment Switch is clicked once.
Manual Rate Increment	Valve movement when the Rate Adjustment Switch is used with the Rate Switch set to Manual.
Minimum Rate	Minimum rate that will be applied with this material.
Maximum Rate	Maximum rate that will be applied with this material.

- b. Units

Setting	Explanation
Seeds Per Pound	Number of seeds per pound.
Target Rate Units	If you select this option, choose one of these at the <i>Target Rate Units</i> screen: Default (kS/a or kS/ha), Bushels.
Bushel Weight	Weight per bushel

5. At the *Application Rate Setup* screen, tap **Row Monitoring**.
6. At the *Row Monitoring Setup* screen, enter the correct settings. When you are finished, tap .
 - a. Alarms

Alarm Setting	Explanation
High Alarm	Triggers when the seed sensor population rises above the selected percentage from the Target Rate for longer than the delay time.
Low Alarm	Triggers when the seed sensor population drops below the selected percentage from the Target Rate for longer than the delay time.
Singulation Low	Triggers when the singulation drops below the selected percentage lower than 100% for longer than the delay time.
Seeds When Off	Triggers when this percentage of seeds are detected while the sections are off for longer than the delay time.
No Seeds When On	Triggers when this percentage of seeds are not detected for longer than the delay time.
Blockage Sensitivity	Triggers when less than this amount of material is sensed for longer than the delay time.

- b. Delays

Delay Settings	Explanation
High Alarm	Amount of time that the row sensor population has to be above the High Alarm setting before warning.

Delay Settings	Explanation
Low Alarm	Amount of time that the row sensor population has to be below the Low Alarm setting before warning.
Singulation Low	Amount of time that the singulation has to be below the Singulation Alarm setting before warning.
Seeds When Off	Amount of time that the Seeds When Off setting is above the Seeds When Off Alarm setting before warning.
No Seeds When On	Amount of time that the Seeds When On is above the No Seeds When On Alarm setting before warning.
Blockage Alarm	Amount of time that the Blockage Alarm is outside the Alarm setting before warning.

c. Thresholds



Threshold Setting	Explanation
Skips Threshold	If no seeds fall within the percentage of theoretical seed placement, it is considered a Skip.
Multiples Threshold	If two or more seeds fall within the percentage of the theoretical seed placement, it is considered a Multiple.
Average Sample Size	The number of seeds used to calculate the averages.
Misplaced Seeds Threshold	If seeds fall outside of this percentage from the theoretical seed placement, they are considered misplaced and will reduce the spacing quality.
Population Adjustment	Adjusts the population reading of the seed sensors, independent of the Rate Population.

d. Population Adjustment

Set the Population Adjustment Percentage. In most cases, this setting will be 0%. (This feature is for Higher Population Planting.)

7. At the *Operation Setup* screen, enter the correct settings and tap  when finished.

Operation Settings	Explanation
Jump Start Speed	<p>The speed that the control system will use when the master switch is held in the Jump Start Position.</p> <p>The Rate Switch has to be in Position 1 or 2 for the Jump Start Feature to work.</p>
Shutoff Speed	The system will shut down if the vehicle drops below this speed.
Minimum Override Speed	The system will continue to run at this speed if the vehicle drops below this speed.
Apply Latency to Boundary	<ul style="list-style-type: none"> • Yes: The system starts when needed to begin applying immediately when crossing a boundary. • No: The system starts when the boundary is reached and any mechanical delay could leave a gap between the boundary and where the product is applied. When GNSS accuracy is low, this is the preferred selection. <p>This setting only applies to fields that have a boundary.</p> <p>This setting is also applied when you exit an exclusion zone and return to the workable area of the field.</p>
Rate Snap	<ul style="list-style-type: none"> • Enabled: Shows the Applied Rate the same as the Target Rate when the Applied Rate is within 10% of the Target Rate. • Off: Shows the actual Applied Rate.

- After you complete all the Material Type options, tap  to return to the *Material Setup* screen.
- At the *Operation Setup* screen after you tap , the setup of this material is complete. The *Material Setup* screen now shows **New Material** and **Delete All** buttons and a list of the materials you have set up.

Control setup for a location

- At the *Implement* screen, tap **Control Setup**.
- At the *Control Setup* screen, tap the location button for the location you want to set up. If this is the first time that you are completing a control setup, there will be one button only: **Unassigned**.

3. At the *Unassigned* screen, tap **Edit** and complete the settings as they apply.
 - a. Material Setup
 - b. Material Control
 - c. Section Control Setup
 - d. Rate Control Setup
 - e. Row Monitoring Setup
 - f. Sensor Setup
4. At the *Edit* screen, select each option in sequence and complete all options and settings. If you tap , the next sequence of screens display or the *Edit* screen displays where you can select the next option. Additional options display as you complete each one.

Material assignment

At the *Material Setup* screen, you can switch the materials into a control location. The location button shows the name of the location and the material that is currently assigned.

- Location name: Enter a name for the location
- Material Assignment

Setting	Explanation
No Material	This is the default of a location and means that the location is disabled.
Named materials (for example, Corn, Soy)	Select a material to assign to the location. To change the material, tap the location button (in this example Hoppers) and select a new material. To disable the location, tap No Material . If the material you require is not listed, exit from this screen and then set it up using the Material Setup procedures. See Material assignment, 128 .

Material control

At the *Material Control* screen, choose how the application of the material will be controlled.

Setting	Explanation
Switch Boxes	The location is linked to both the master switch box and the 12-section switch box.

Setting	Explanation
Touchscreen Only	The location is controlled from the touchscreen. Note – <i>The CFX-750 display requires the use of a 12-section switch box for section control.</i>

Section Control setup

If you are using section control or rate control as section control, complete these settings.

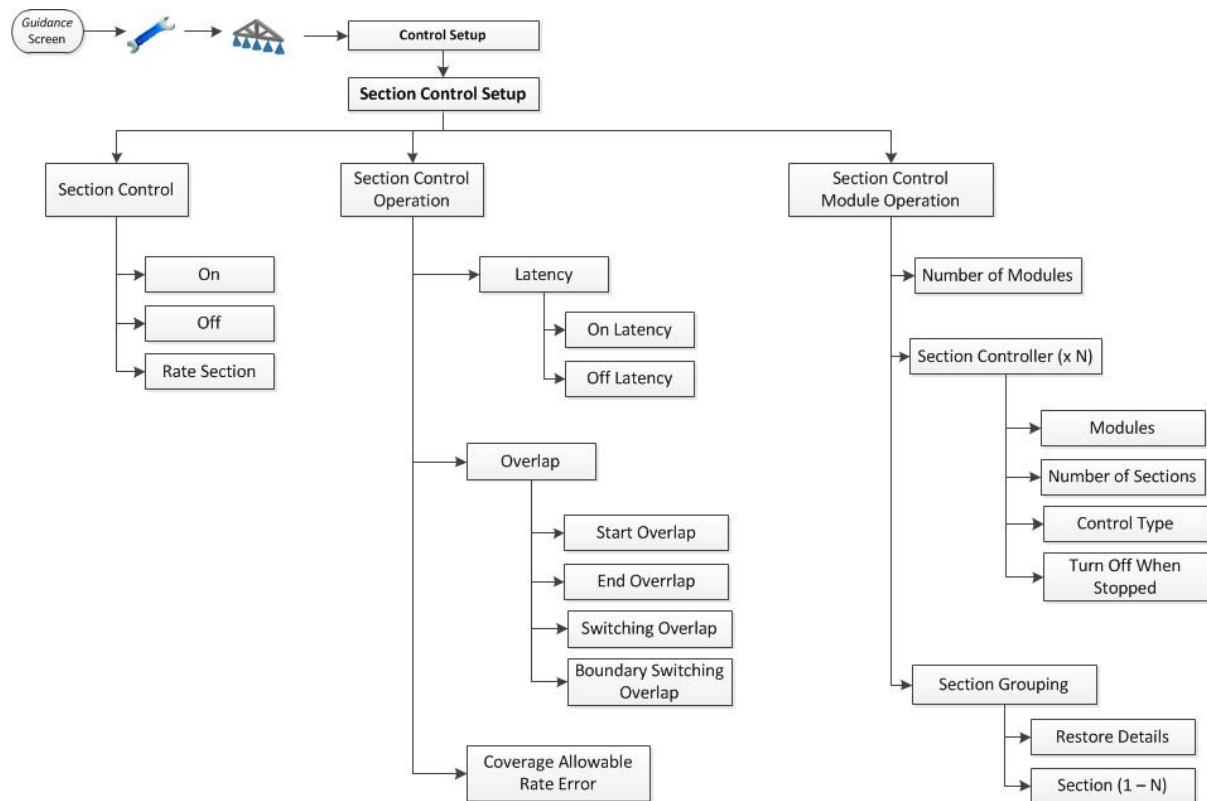

1. At the *Section Control* screen, turn section control on or off and set whether to use rate control for section control. Then tap .



Setting	Explanation
On/Off	Turns section control on or off for this location.
Rate As Section	Use the rate control as section control. When this option is chosen, the rate will go to zero and shut down the control in a covered area or non-productive zone.

2. At the *Latency* screen, set the time lag for application. Then tap .

Setting	Explanation
On Latency	The length of time before a material is applied when the section is turned on.
Off Latency	The length of time before a material stops applying after the section is turned off.

3. At the *Overlap* screen, set the amount of overlap you intend to have when applying material. When you are finished with these settings, tap .

Setting	Explanation
Start Overlap	The amount of intentional overlap required when leaving already covered area and going into a non-covered section of the field.
End Overlap	The amount of intentional overlap required when going into a covered area.
Coverage Switch Overlap	The amount of side-to-side coverage overlap before a section shuts down.
Boundary Switch Overlap	The amount of side to side boundary overlap before a section shuts down.

4. Coverage Allowable Rate Error: Use this setting only if you are running very large fields. Then tap .
5. At the *Section Control Module Location* screen, complete the settings for each module. When you are finished with these settings, tap .

Setting	Explanation
Modules	Tap the serial number of the module you want to assign to the location.
Number of Sections	Select the number of sections to assign to the selected module.





Setting	Explanation
Control Type	<ul style="list-style-type: none"> • Air Clutch: The section control module sends power to the section valve to turn the clutch on to stop planting. • Boom Valve: The section control module sends power to the section valve to turn the boom valves off. • Electric Clutch: The section control module sends power to the electric clutch to stop panting. • LiquiBlock: The section control module sends power to the boom nozzles off.
Turn Off When Stopped	<ul style="list-style-type: none"> • Yes: The section closes (turns off) when stopped. • No: The section remains open (turned on) when stopped.

6. At the *Section Grouping* screen, complete the settings to match how the sections are physically configured on the implement. When you are finished with these settings, tap .

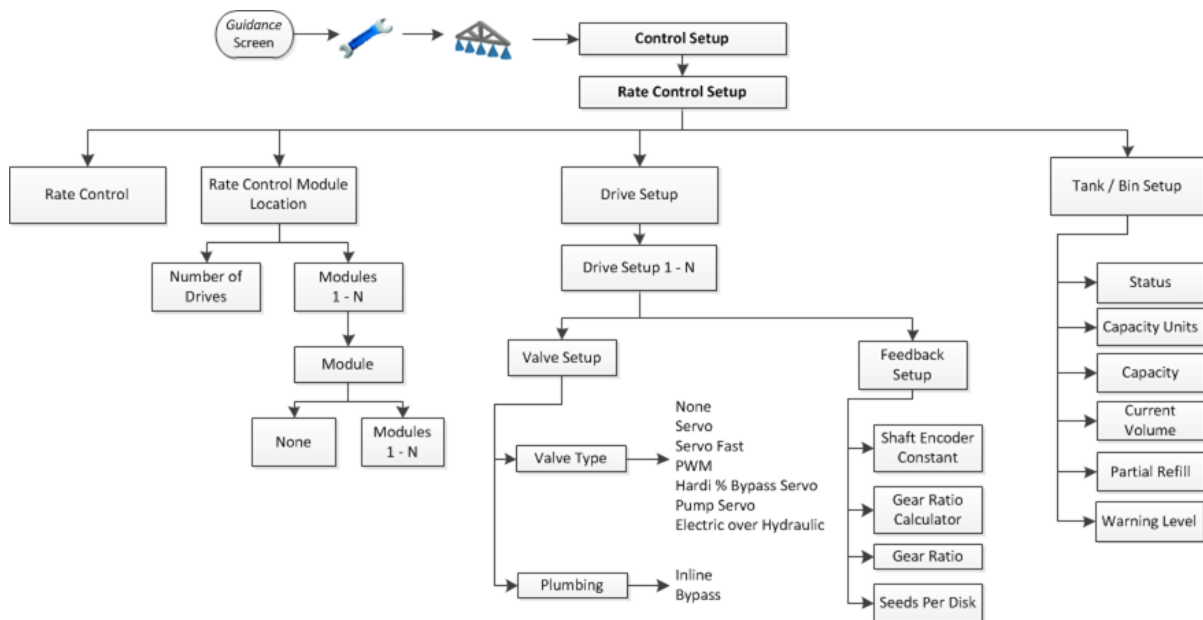
Setting	Explanation
Restore Defaults	<p>Return the settings to default.</p> <p>Note – For the default, rows are divided evenly across all sections. In most applications, this will be the correct setup.</p>
Section button(s)	<p>Start with Section 1 and select the number of rows that are connected. Continue with the sections in sequence until all rows are assigned.</p>

Rate Control Setup





1. At the *Rate Control Setup* screen, tap **Rate Control** and then tap **On** to turn on the rate control feature. Tap .
2. At the *Rate Control Module Location* screen, choose the number of drives at this location and tap . The system displays a button for each module.
3. Complete the settings for each module:
 - a. Tap **Module**. The *Module* screen displays. Tap .
 - b. Tap **Modules**. The *Modules* screen displays, with the serial number of each module.
 - c. Tap the serial number of the module connected to that location and tap .
4. At the *Rate control Module Location* screen, set the width of the selected location. Tap .

Note – If you have one drive only selected, you will only have one *Module Setup* to perform and the width is then assumed to be the full implement width.

5. Complete the settings for each drive:
 - a. At the *Drive Setup* screen, tap **Drive Setup** for the serial number of the drive.
 - b. At the *Valve Setup* screen, tap **Valve Type** and set the type of valve physically connected to the module. When settings are complete, tap  to return to the *Valve Setup* screen.

Note – These settings also control the default setting for Valve Response.

Setting	Explanation
Servo	Standard 2-wire servo, performs more slowly.
Servo Fast	Fast 4-wire servo, performs more quickly.
PWM	2-wire PWM valve, commonly used to control hydraulic flow to the pump.
Hardi % Bypass Servo	Used on Hardi sprayers equipped with 3-way section valves that return flow to the tank when the boom section is off.
Pump Servo	Servo valve commonly used to control hydraulic flow to the pump.
Electric Over Hydraulic	A valve that uses electric current to control the hydraulic valve output.

- c. At the *Valve Setup* screen, if the valve is a servo type, tap Plumbing and complete the settings. After completing the settings, tap . If your valve is not a servo type, tap .

Note – Servo-type valves are Servo, Servo Fast, and Hardi % Bypass Servo. Pump Servo does not have a plumbing type because it controls hydraulic flow to the pump. This is similar to a PWM setup.

Setting	Explanation
Inline	<p>The control valve is between the pump and the sections/nozzles. This means that the control valve controls the amount of material out to the section/nozzles directly.</p> <p>Note – To increase the amount of material that is sent to the section/nozzles, the control valve must open more in order to force more material to the sections/nozzles.</p>
Bypass	<p>The control valve is between the pump and the tank. This means that the control valve controls the amount of material that goes back to the tank.</p> <p>Note – To increase the amount of material that is sent to the section/nozzles, the control valve must close more in order to force more material to the sections/nozzles.</p>

- d. At the *Feedback Setup* screen, complete the settings for the drive and tap .

Setting	Explanation
Shaft Encoder Constant	Enter the pulse per revolution for the feedback sensor you have connected to this module.
Gear Ratio Calculator	Use the calculator to calculate the gear ratio, if required.
Gear Ratio	Enter the gear ratio from the feedback sensor to the seed disk.
Seeds Per Disk	Enter the number of holes in the seed disk.

- e. At the *Tank/Bin Settings* screen, complete the settings for the drive and tap .

Setting	Explanation
Status	Tap On to enable the Tank/Bin. Tap Off to turn the Tank/Bin setup off.
Capacity Units	Select the units for the Tank/Bin.
Capacity	Set the total volume for the Tank/Bin.
Current Volume	Enter the current volume of material in the Tank/Bin.
Partial Refill	Enter a amount that you want to use for a partial refill.
Warning Level	Enter the amount of material that you want to trigger a Low Material Warning.

Row Monitoring Setup

Complete the row monitoring settings that are appropriate for your configuration.

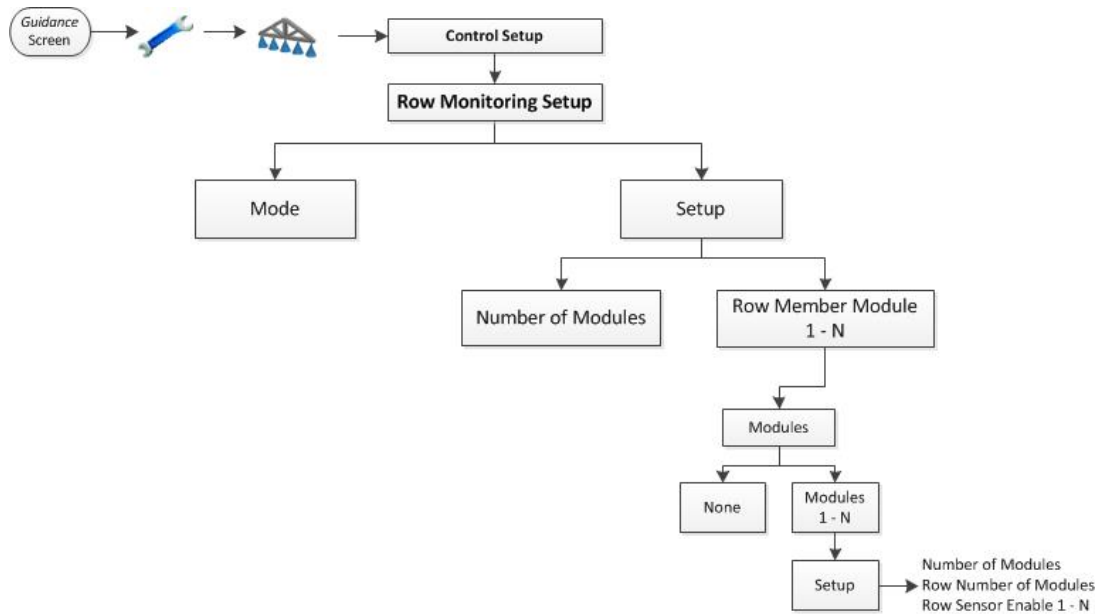

1. At the *Mode* screen, choose the type of row monitoring you want:

- None
- Blockage
- Seed Count

When you are finished, tap .

2. At the *Setup* screen, complete settings for modules. When you are finished, tap .

Setting	Explanation
Number of Modules	Select the total number of row monitoring modules you have connected to this location.

Setting	Explanation
Row Member Module Assignment	<p>Tap the button of the location you want to set up first, then tap the serial number of the row monitoring module connected to this location.</p> <p>Note – <i>If you have two row monitoring modules at this location, repeat these steps for the second module. You are limited to two modules per location.</i></p>
Row Sensor Enable	Enable and disable individual sensors.

Sensor Setup

After you select a sensor type, complete all settings. Tap  to go to the next screen.

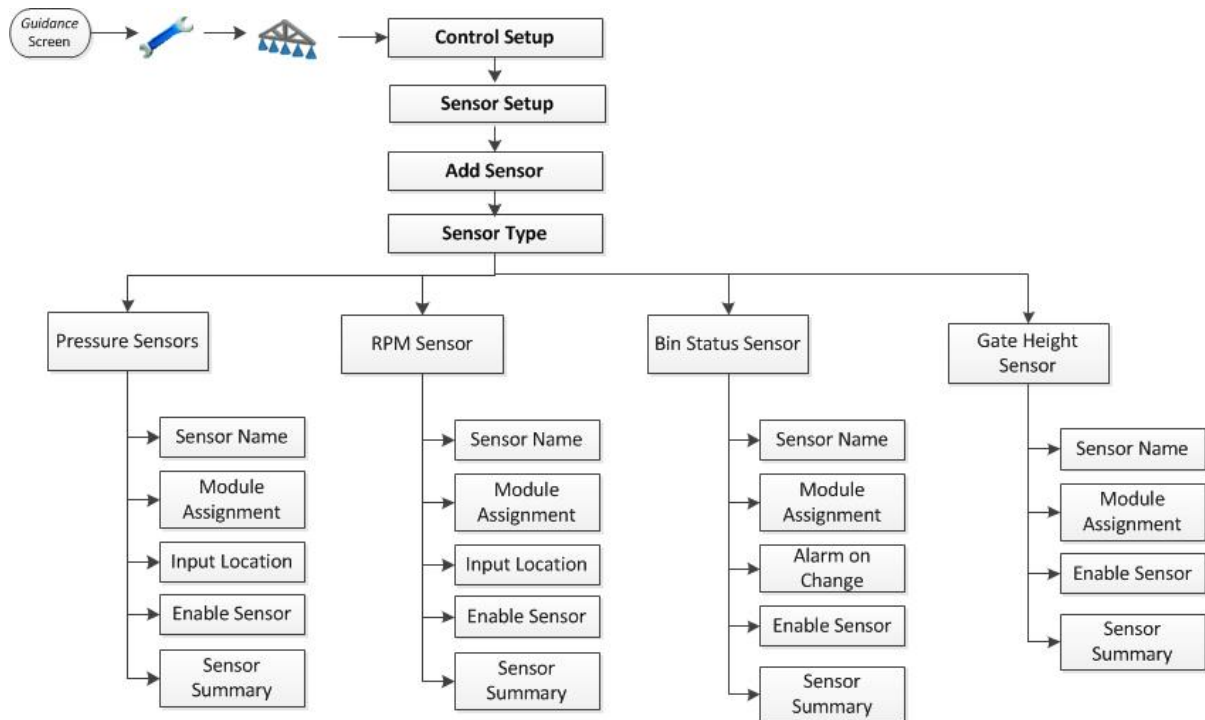

Note – Not all options apply to all sensors.

- At the *Sensor Type* screen, select the type of sensor you want to set up.
 - Air Pressure
 - Liquid Pressure
 - NH3 Pressure
 - Vacuum Pressure
 - RPM Sensor
 - Bin Status Sensor
 - Gate Height Sensor
- At the *Sensor Name* screen, use the on-screen keyboard to enter a name for the sensor.
- At the *Module Assignment* screen, tap the serial number of the module the sensor is connected to.
- The next screens that display depend on the type of sensor you have.

Sensor Type	Screen	Explanation
Pressure sensor	<i>Input Location</i>	Select where the sensor is connected on the module.
RPM sensor	<i>RPM Calibration</i>	Enter the Pulse per Revolution number for the RPM sensor.
Bin state sensor	<i>Alarm on Change</i>	Select the change of state that will trigger the sensor alarm: <ul style="list-style-type: none"> • Low to High: The alarm is triggered when the module sees the sensor go from 0 V to 12 V. • High to Low: The alarm is triggered when the module sees the sensor go from 12 V to 0 V.
Bin status sensor	<i>Alarm Text</i>	Enter the text you want to display when the alarm is triggered.

5. At the *Enable Sensor* screen, enable or disable the sensor.
6. At the *Sensor Summary* screen, review the summary. If all settings are correct, tap .

System Status

Select this option to view the status for:

- Master Switch Module
- Section Switch Module
- Rate Control Module
- Section Control Module
- OEM Switch Interface
- Accessories

Hydraulics Test



WARNING – MOVING PARTS DURING THIS TEST! Please stay clear of the implement. Ensure the implement is raised, the transmission is in PARK, and the emergency brake is applied before continuing.

After the Field-IQ setup is complete, the display tests the hydraulics of your system. During this test you must run the motor(s) at the minimum and maximum RPM and make sure the motor(s) achieve these RPM.

Calibrations

After the hydraulics test is complete, the display calibrates your system. The available calibrations are:

- Field-IQ Rawson Control Module
- Servo Pump or PWM Pump
- Pressure Sensors
- Implement Lift Switch

When the calibration is complete, save the data to a configuration file and export it to the USB drive. See [USB drive data transfer, 183](#).

Boom Height Control setup

In this chapter:





Boom Height Control hardware installation	142
Field-IQ Boom Height Control setup	142
Boom Height Control calibration	144

With the Field-IQ Boom Height Control system, the CFX-750 display can control the height of spray nozzles above a crop canopy or bare ground.



Boom Height Control hardware installation



For information on installing the Boom Height Control system on your equipment, refer to the *Boom Height Control Platform Installation Instructions*. For the latest versions of these documents, visit www.trimble.com/agriculture.

Field-IQ Boom Height Control setup

1. At the *Guidance* screen, tap .
2. At the *Settings* screen, tap .
3. At the *Implement* screen tap **Boom Height Control**.
4. At the *Height Control* screen, tap **Height Control Setup Wizard**.
5. At the next screen, tap **Enable** and then tap .
6. At the *Welcome to Boom Height Control Setup* screen, tap  to start the Boom Height Control Setup Wizard.
7. At the *Boom Control Option* screen, select a control option and then tap .

Control Option	Explanation
Monitor Only	Auto-height control is not used. The SS100 sensors are used to monitor the height above the crop or ground.
Left and Right Booms	Auto-height control is used for the wings only.
Booms + Center Section	Auto-height control is used for the wings and the center section.

8. At the *Hydraulic Valve Control Module* screen, tap the serial number of the Hydraulic Valve Control module and then tap .
9. At the *Height Sensor Setup* screen, tap **Number of Height Sensors**.
Note – You must set up at least one sensor for each control zone to use the boom height control system.
10. At the *Number of Height Sensors* screen, choose the number of height sensors that are attached to the boom and then tap .
11. At the *Height Sensor Setup* screen, tap each of the sensor location buttons in sequence and complete the settings. Then tap .
12. Complete each sensor setting and then tap

 to continue. Repeat until all sensors are set up then tap .

Setting	Explanation
Sensor Module	Tap the serial number of the sensor that is installed in the selected location.
Enable Sensor	Enable or disable the sensor.
Side Offset	The distance from the center line of the sensor to the hinge point of the boom
Nozzle Offset	The distance from the bottom edge of the sensor cone to the outlet of the spray nozzle tip.

13. At the *Boom Height Manual Control* screen, verify the correct operation of the Manual Boom Switch detection by monitoring the circles next to the control sections. Do this for each of the Manual control switches.

If you use the:



- Raise position on the manual switch, the top circle should turn green
- Lower position on the manual switch, the bottom circle should turn green

14. At the *Height Control Operation Setup* screen, complete the height control settings.

Setting	Explanation
Sensing Mode	<ul style="list-style-type: none"> • Ground: Target height is based on the surface of the ground. Select Ground mode to sense the ground surface through low coverage vegetation, such as stubble or young crops. Ground mode is susceptible to unwanted reflectance on hard or wet surfaces, such as bare ground. If this is an issue, select Canopy mode. • Canopy: Target height based on the height on the crop canopy. Select Canopy mode to sense the closest object seen. This is used to sense bare ground or high-coverage broad leaf crop canopy.
Target Height	The desired height above the ground or crop canopy, depending on the sensing mode.
Boom Down Rate	Lower this setting to reduce the maximum downward speed of the boom.

Setting	Explanation
Boom Roll Stabilizer	Raise this setting to increase the boom roll stability. Note – Raising this setting will decrease the downward speed of the boom.
Height Error Indication Band	This is the band for which the screen will indicate you are on-target height. Note – This setting is for on-screen indication and does not affect performance.
Target Height Step	The distance that the target height should change when you tap Increase or Decrease.
Minimum Target Height	The minimum height that the Target Height can be set to. On a multi-sensor control zone, this setting is used as a minimum height for the average of the system. For quicker performance, set this value close to the Target Height setting.
Maximum Target Height	The maximum height that the target height can be set to.
System Aggressiveness	The aggressiveness for the Boom Height Control system. A higher number is more aggressive and a lower number is less aggressive.

Boom Height Control calibration

1. At the *Guidance* screen, tap .
2. At the *Settings* screen, tap .
3. At the *Implement* screen tap **Boom Height Control**.
4. At the *Height Control* screen tap **Hydraulic Valve Calibration**.
5. At the *Hydraulic Valve Calibration* screen, tap the **Zone** you want to calibrate.
6. At the *Zone Valve Calibration* screen, tap **Deadband and Slope**.

Note – Make sure that you lower the center section to a lower height and level the booms before you start the calibration procedure. If the Center or Booms are too high or too low, the calibration may fail.
7. At the *Deadband Calibration* or *Slope Calibration* screen, tap **Engage** to start the calibration.
8. Repeat Step 5 through Step 7 until all zones are calibrated, and then tap .

Mapping guidance setup

In this chapter:

Guidance and mapping	146
Guidance settings	146
Implement setup for guidance	151
Curve smoothing settings	153



Settings for mapping guidance lines and patterns enable you to customize how tight your turns are, coverage logging, warning distances and switching between infill guidance lines and headlands.

Guidance and mapping

To receive guidance information (and any assistance from an auto steer system) you must:

- Set up how the guidance displays on your screen. See [Guidance settings, 146](#).
- Set up the implement for guidance. See [Implement setup for guidance, 151](#).
- Change settings for curve smoothing as needed. See [Curve smoothing settings, 153](#).

Guidance settings

1. At the *Guidance* screen, tap .
2. At the *Settings* screen, tap , and then tap the option you want to setup:
 - [Turn Settings](#)
 - [Coverage Settings](#)
 - [Nudge Settings](#)
 - [Mapping](#)
 - [FreeForm Recording](#)
 - [Headland/Infill Switching](#)
 - [Boundary Setup](#)

Turn Settings

Turn settings include:

- [Minimum turn radius mode](#)
- [Auto U-turn](#)
- [Tight turn alert threshold](#)

Minimum turn radius mode

This setting creates smoother corners on curved AB lines, which improves the accuracy of your auto steer system when steering on curves.

Setting	Explanation
Automatic (This is the default mode.)	Set the radius to 80% of the swath width or 32.8' (10 m), whichever is larger.

Setting	Explanation
Disabled	No attempt is made to keep the corners above a minimum turn radius. If you use this mode, curves may be very tight and the auto steering system may be unable to successfully complete the turn.
Manual	Manually choose the minimum radius.

Tight turn alert threshold

The CFX-750 display alerts you when your machine is within a specified distance of a tight turn.

The threshold is set between 1 and 10. To increase the sensitivity of the alert, lower the number.

Auto U-turn detection

Auto U-turn detection operates only on FreeForm™ and adaptive curve patterns. For more information, see [Guidance settings, 146](#).

Setting	Explanation
On	Automatically detects when the vehicle has done a U-turn and generates the next guidance line.
Off	Manually controls when a path is finished. With the FreeForm pattern, you must manually stop recording. With the adaptive curve pattern, you must manually set the B point.

Coverage Settings

Configure *Coverage Settings* to suit the requirements of your system.

Coverage on/off delay

Coverage delay causes the system to delay coverage logging to match the time it takes for your flow to start when you turn your spraying or spreading system.

Turn coverage delay on if you activate coverage logging when you enable your spreading or spraying. Coverage delay ensures that the display is recording coverage from the actual start point of application. You can enter a delay time between 0.0 - 10.0 seconds.

Coverage logging

Coverage logging can be recorded at speeds as low as 0.8 mph (1.3 km/h).

Setting	Explanation
Disabled	Turn coverage logging off.
Manual	Turn coverage logging on and off manually.
Engaged	Automatically enable coverage logging when the auto steer system is engaged.
Switch	Use a remote switch to turn coverage logging on or off.

Nudge settings

Nudge settings affect how nudge adjustments work during operation.

Setting	Explanation
Clear nudge at swath end	When enabled, the display clears the nudged position each time you change swaths.
Reset nudge	When enabled, any applied nudge is cleared and all swaths return to their original positions.
Nudge increment	Each nudge moves the guidance line by this value. The default nudge increment is 0' 1" (2.5 cm). Enter a value between 2 - 12" (3 - 30 cm).

Mapping

Use this setting to set warning distance and recording positions for point, line and area.

Warning distance

Setting a warning distance causes the system to alert you when your machine approaches a feature.

As the machine moves within the specified warning distance, a warning displays. If you have an EZ-Pilot, EZ-Steer or Autopilot system with a sonalert connected, an audible alarm also sounds.

You can set the warning distance to between 0'00" - 984' 03" (0.0 - 300.0 m).

Recording position



Choose the point at which a feature is recorded. When your vehicle is at this point, the feature will be recorded.

Delete features

Use this function to delete point, line, and area features from a selected field. Only the features are deleted, and not the field itself.

FreeForm Recording

Use this setting to choose how the display records a FreeForm pattern.

Setting	Explanation
Manual	<p>Use the icons on the <i>Guidance</i> screen to control when the path is recorded.</p> <p>To start recording tap , to stop, tap .</p>
Record with coverage	<p>Automatically begin and end recording the FreeForm pattern when coverage logging begins and ends.</p> <p>You can still use the FreeForm recording icon to manually override recording.</p>

Headland/Infill Switching

Use this setting to choose how guidance switches between the headland and the infill part of the field.

Setting	Explanation
Automatic	Automatically switch from headland to infill when the vehicle moves inside the inner headland boundary.
Manual	Use the controls on the <i>Guidance</i> screen to select when guidance switches from headland to infill.

Boundary setup

Use the *Boundary Setup* option to configure:

- When boundaries are active. See [Boundaries](#).
- How the display records boundaries. See [Expand Boundaries](#).

When you record a boundary, the display automatically calculates the area of the boundary and shows this information on the *Status* tab.

When you load a field that contains a boundary, the boundary also loads.

You can record multiple boundaries in a single field.

If your variable rate controller has section switching capability, a boundary acts as a switching barrier. When you move outside the boundary, the controller will automatically switch off the implement.

Boundaries

Setting	Explanation
Enabled	Use existing boundaries and create new ones for all your fields.
Disabled for this field	Turn off boundaries for only the current field you are working in. When you begin your next field, the option will automatically change to Enabled.
Disabled for all fields	Turn off boundaries for all fields you work in, including boundaries made with headland patterns.

Expand Boundaries

Use this setting to determine how the display manages the boundary after you finish recording.

Setting	Explanation
Do not expand	Not alter after you have finished recording
Half swath width	Expand by one half swath width toward the outside of the pass
One swath width	Expand by one full swath width toward the outside of the pass

Implement setup for guidance

Before you can use the display for guidance, you must configure your implement.

1. From the *Guidance* screen, tap  and then tap **Create New Field**.
2. At the *Create New Field* screen, tap **Implement Setup**.
3. Edit the settings for each option. For more information, see [Implement setup for guidance, 151](#).
4. Select a pattern type (see [Implement setup for guidance, 151](#)) and continue through the wizard.

For optimum guidance, make sure that you enter accurate information for the implement that is attached to the vehicle. Incorrect information may result in gaps and overlaps in coverage.

Enter the measurements as follows:

- *Implement Width*: 1' 00" - 328' 01" (0.305 - 99.990 m)
- *Overlap/Skip*: 394" skip and 394" overlap (1000 cm)
To avoid skips in application coverage, set an intentional overlap.
- *Left/Right Offset*: 1969" right and 1969" left (5000 cm)

Adjusts guidance and coverage logging when...	Explanation
The implement is offset from the vehicle center line.	When configured and online, the implement should be over the guidance line, with the vehicle to the side. For guidance when driving, use the LEDs on the lightbar. See Lightbar patterns, 228 .

- *Forward/Back Offset*: 1188" behind and 384" forward (3018 cm - 975 cm)

Adjusts guidance and coverage logging when...	Explanation
The implement is not centered directly under the GNSS antenna (for EZ-Steer systems) or the fixed axle of the vehicle (for Autopilot systems).	Set a Forward Offset when the implement is forward of the antenna (on the front of the vehicle) for EZ-Steer systems, or forward of the fixed axle of the vehicle for Autopilot systems. Set a Back Offset when the implement is behind the antenna (on the back of the vehicle) for EZ-Steer systems, or behind the fixed axle of the vehicle for Autopilot systems.

- *Implement Draft*: 393.7" left and 393.7" right (1000.0 cm)

This setting adjusts guidance and coverage logging when there is a variable implement draft caused by a side slope and/or an implement pulling to one side.

- *Implement Mount Type*: Choose the type of implement mount that is in use.



Curve smoothing settings

By default, the settings for CFX-750 display smooths curves for improved guidance and auto steering.

However, you can disable curve smoothing on tight turns (curves that have a radius of less than 3m (10 ft.).

Note – *If you disable curve smoothing, the CFX-750 display or the Autopilot system may not be able to auto steer around the tighter turns. Be careful when you disable curve smoothing.*

To disable curve smoothing:

1. At the *Guidance* screen, tap .
2. At the *Settings* screen, tap .
3. Tap **Turn Settings**.
4. Tap **Minimum Turn Radius Mode** and then tap your choice: automatic, disabled or manual.

Yield Monitoring setup

In this chapter:



Yield Monitoring setup	156
Yield Monitoring calibration	158
Yield Monitor status	163

With the Yield Monitoring system, the CFX-750 display can access and display data about your yield that is collected by yield monitoring sensors.

Yield Monitoring setup

1. At the *Guidance* screen, tap .
2. At the *Settings* screen, tap .
3. At the *Implement* screen, tap **Yield Monitor**.
4. At the *Yield Monitor* screen, tap **Yield Monitor Wizard**.
5. At the *Yield Monitor Type* screen, tap the type of yield monitor you have connected and tap .

Note – If you tap **None**, this removes the Yield Monitor Plugin from the Guidance screen.

6. At the *Summary* screen, a summary of the hardware attached to the CFX-750 display is listed. Tap .
7. At the *Combine Setup* screen, select the **Combine Make, Model, and Moisture Sensor** type, and then tap .
8. Enter in sequence the appropriate settings for *Implement Measurement* and then tap .

Note – For information about implement measurement, see [Field-IQ setup for implements, 119](#).

- Implement Width
 - Number of Rows (or sections for the header swath control)
 - Overlap/Skip
 - Left/Right Header offset
 - Forward/Back Offset
 - Allowable Side to Side coverage overlap
9. At the *Yield Monitoring Setup* screen, complete the settings appropriate for the vehicle and then tap .

a. Operation Setup

Setting	Explanation
Header height Sensor	Enable or disable logging control, based on the header height sensor.
Header Height	The height percentage at which logging turns on and off.
Grain Flow Delay	The length of time the combine takes to process grain for correct mapping of yields. This value should be the time it takes grain to go from the header to the grain tank.
Reset Autocut	Enables the reset of swath control to full width when header is raised and lowered

b. Crop Setup

Setting	Explanation
Commodity	The commodity for the crop.
Units	Tap which units of measure will be shown on the display for yield.
Moisture Upper Limit	The highest moisture value that will be recorded for a crop sample.
Standard Bushel Weight	The standard density for the crop being harvested.
Storage Moisture	The standard moisture that wet yield will be adjusted to for dry yield.
Paddle dimensions	Verify the length, width, and distance between the paddles on your machine. Note – Failure to verify these dimensions can cause degraded performance.
Elevator pitch	Verify the pitch angle of the clean grain elevator from the vertical and the distance of the sensors from the rear wall. Note – Failure to set the correct optical sensor spacing from the rear wall can cause degraded performance.

- c. Option Setup: Enables or disables the *Start New Load* confirmations. If you enable this setting, the operator has the option to confirm that they want to end the load. If you disable the setting, the operator is not prompted to confirm the end of the load they tap the **New Load** button.
- d. Bin Volume: Enter the size of the combine's grain tank.
- e. Bin Display Type: Select the option to view the current grain bin capacity in either actual units or as a percentage of the bin capacity.
- f. Map Legend Setup: Enables you to determine the scale on the Yield and Moisture layers that are displayed on the CFX-750 display.

Yield Monitoring calibration

You must perform calibration of the equipment before going to the field.

Calibrations include:

- Calibrations that are performed before entering the field:
 - Header Height Calibration (see [Header Height Calibration, 158](#))
 - Tare Calibration (see [Tare Calibration, 159](#))
 - Temperature Calibration (see [Temperature Calibration, 159](#))
 - Roll Calibration (see [Roll Calibration, 160](#))
- Calibrations that must be performed in the field:
 - Yield Flow Calibration (see [Yield flow and moisture sensor calibration, 160](#))
 - Moisture Sensor Calibration

Calibrations before entering the field

The following calibrations are done before you enter the field.

Header Height Calibration

The Header Height Calibration wizard enables you to set the high and low points for the header height position.

Note – For accurate operation, the highest and lowest point of header operation must fall within the 0-5 Volt range of the sensor. If the sensor reaches maximum value **before** the full range of the header movement, you will need to adjust the linkage on the sensor.



1. At the *Yield Monitor Calibration* screen, tap **Header Height Calibration** to start the calibration wizard.

2. Raise the header to its highest point, and then tap .



3. Lower the header to its lowest position, and then tap .





4. Set the *Header Height* percentage at which logging should toggle on and off, and then tap .
5. After you have completed calibration for header height, tap .

Tare Calibration

Tare is the average thickness of the paddle.

Note – *Tare calibration is important to the performance of the system. Ensure that the clean grain elevator is at proper tension with all paddles present and of uniform size.*

1. To tare the yield sensor, engage the separator, run the combine at full throttle, and then tap .
2. Look at the tare result. The results should be close to paddle thickness but may be off a little bit. More important is a small deviation of Tare. This value should be less than 25% of the tare.
Tap .

Temperature Calibration





Note – *Failure to complete this calibration can degrade moisture sensor performance.*

1. Park the combine so that the Yield Monitoring module and moisture sensor are in the shade.
2. Place a thermometer next to the Yield Monitoring module and moisture sensor for a while.
3. Read the thermometer and then enter the correct temperature. Then tap .

Roll Calibration

Note – You need a GNSS location to perform this calibration.

The Yield Monitoring Module has inertial measuring devices to adjust for the terrain you encounter while harvesting.

1. At the *Connector Orientation*, tap the appropriate choice to indicate how the connector is positioned in relation to the vehicle and how *Label Orientation* relates to the vehicle. Tap .
2. At the *Label Orientation* screen, tap the appropriate choice to indicate how the label is positioned in relation to the vehicle. Tap .
3. Park the vehicle on flat ground and mark the inside position of the front and rear wheels.
4. At the *Roll Calibration: Step 1* screen, tap .
5. Wait while the roll is determined.
6. When prompted, turn the vehicle around so that the front wheels are in the position where the rear wheels were and the rear wheels line up with the marks from the front wheels.
Tap  and then wait for the roll offset to be determined.

Calibrations in the field

For accurate performance of the Trimble Yield Monitor, you must calibrate the optical yield sensors and moisture sensor in the field in reference to a known good scale and moisture sensor.

Yield flow and moisture sensor calibration

As part of calibrating yield flow, you collect loads to use for calibration. There are two methods for collecting calibration loads:

- Speed method: Consistent header width, varied speed
- Cut width method: Consistent speed, varied header width

Speed method

This method uses:

- A consistent header width
- Varied speed to calibrate for Low, Medium, and High grain flows, to provide a calibration curve for Low, Medium, and High flow variations throughout the course of harvest

1. Conduct a calibration load of 3,000-6,000 lbs. at your normal harvest speed, making sure to keep it constant.
2. Repeat this procedure for one load each at:
 - 1 mph less than the normal operating
 - 2 mph less than the normal operating speed
 - 1 mph higher than the normal operating speed

Example

An example of calibration loads using this method is as follows:

- Load 1 = 4,547 lbs. @ 2 mph
- Load 2 = 3,834 lbs. @ 3 mph
- Load 3 = 2,764 lbs. @ 4 mph
- Load 4 = 5,768 lbs. @ 5 mph

Cut width method

This method uses:

- A consistent speed
 - Varied cut widths to calibrate for Low, Medium, and High flows
1. Conduct a calibration load of 3,000-6,000 lbs. at your normal constant speed with a 100% cut width (that is, 12 rows at 30 ft).
 2. At the same constant speed, repeat this procedure for one load each at:
 - 75% of the normal cut width (9 rows at 22.5 ft)
 - 50% of normal cut width (6 rows at 15 ft)
 - 25% of normal cut width (3 rows at 7.5 ft)

This provides a calibration curve for Low, Medium, and High flow variations throughout the course of Harvest.

Example

An example of calibration loads using this method:





- Load 1 = 5,768 lbs. @ 4 mph @ 100% swath width
- Load 2 = 4,547 lbs. @ 4 mph @ 75% swath width
- Load 3 = 3,834 lbs. @ 4 mph @ 50% swath width
- Load 4 = 2,764 lbs. @ 4 mph @ 25% swath width

Calibration instructions



1. Collect all calibration loads using either the speed method or cut width method.

It is highly recommended that you conduct a minimum of three calibration loads to ensure that the system provides accurate readings for all low, medium, and high flows throughout harvest.



If you conduct a Single Load calibration, this may result in poor accuracy performance when Harvesting outside the Flow range at which the system was initially calibrated.

2. At the *Guidance* screen, tap .
3. At the *Yield Monitor Quick Access* screen, tap **Load Details**.
4. At the *Load Details* screen, tap each load button and complete the settings for each load:
 - a. Scale Ticket Weight: Enter the weight and then tap .
 - b. Test Weight: Enter the weight and then tap .
 - c. Moisture: Enter the moisture for the load and then tap .

Note – Evaluate each load for the flow variance. Only use loads that have a low flow variation in the calibration.

5. At the *Yield Sensor Calibration* screen, tap **Yield Sensor Calibration**.
6. At the *Load* screen, confirm the loads to be used in the calibration and then tap .
7. At the *Yield Sensor Calibration* screen for the load, confirm the load adjustments. Tap **Yes** or **No** and then tap .
8. At the next screen, choose whether you want to apply the sensor calibration to previously recorded loads in the field (tap **Yes**) or not (tap **No**). Then tap .

A message displays stating that the current load has been calibrated successfully.

9. At the *Yield Monitor Quick Access* screen, tap **Moisture Sensor Calibration**.
10. At the *Moisture Sensor Calibration* screen, tap the load you want to calibrate.
11. At the load screen for the load you chose, tap **Scale Ticket Moisture** and enter the correct moisture from the scale ticket. Tap **Use in Calibration** if you want to use the value in the calibration and then tap .
12. At the *Moisture Sensor Calibration* screen, tap **Yes** and then tap  to confirm the calibration adjustments.

Yield Monitor status

System status

The *Yield Monitor Status* screen provides detailed information on the system:

- Field wet weight
- Load wet weight
- Moisture
- Header height
- Roll angle
- Pitch angle
- Flow
- Temperature
- Density
- Tare

Optical sensor status

The *Sensor Status* screen provides information on the operation of the optical sensor:

- Optical sensor status
- Noise level
- Elevator speed
- Percent dark
- Moisture sensor
- Sensor value
- Temperature



GNSS setup

In this chapter:

GNSS setup	166
Correction services setup	168
Position quality	173
GNSS advanced settings	173
GNSS status	174

As part of GNSS setup, you choose the type of radio, correction service, position quality and whether to use xFill technology.

GNSS setup

1. At the *Guidance* screen, tap .
2. At the *Settings* screen, tap .
3. At the *GNSS* screen, tap **GNSS Setup**.
4. Tap *GNSS Correction Source*. Choose the appropriate position correction source:
 - WAAS / EGNOS: Free satellite-based corrections:
 - WAAS (Wide Area Augmentation System) in North America
 - EGNOS (European Geostationary Navigation Overlay Service) in Europe
 - OmniSTAR VBS: Satellite-based service available through a subscription
 - OmniSTAR XP/HP/G2: High accuracy satellite -based service available through a subscription
 - RTK (Real Time Kinematic): Radio-broadcast corrections from a ground-based reference station.

When you tap RTK as the GNSS Correction Source (depending what is unlocked), additional settings may display.

Setting	Options
Correction delivery method (See Correction services setup, 168)	<ul style="list-style-type: none"> • Internal Trimble Radio • External Trimble Radio • CenterPoint™ RTX™ <ul style="list-style-type: none"> • Fast satellite • Standard satellite • Standard cellular • Fast cellular • RangePoint™ RTX • Trimble VRS™ Modem • Generic CMR Radio • Generic RTCM3 Radio

Setting	Options
Internal Trimble Radio or External Trimble Radio	<p>If you tap one of the Trimble radio options for the correction delivery method, you can also enter:</p> <ul style="list-style-type: none"> • Radio Network ID • SecureRTK Keys • SecureRTK Keys Status • Use xFill™ (technology): tap Yes or No. If you tap Yes, the <i>xFill Lband Settings</i> screen and <i>RTK Base Datum</i> screen display. • xFill Lband Settings (tap the frequency and baud rate) • RTK Base Datum: Select the datum that was used when the RTK base station was surveyed. For more information, contact your local reseller. <p> CAUTION – You must select the correct base datum for your location. If you select an incorrect value, this will result in an incorrect xFill operation.</p>
Trimble VRS Modem or CenterPoint RTX (std-cell)	<p>If you select the Trimble VRS Modem or CenterPoint RTX (std-cell) option for the correction delivery method, you can also select your device (DCM-300 or Ag3000).</p>
Any OmniSTAR® option or CenterPoint RTX	<p>If you select any OmniSTAR or CenterPoint RTX option for the correction delivery method, also enter:</p> <ul style="list-style-type: none"> • Frequency and Baud Rate • Threshold for Favor Accuracy • FastRestart: On, Off

- RangePoint RTX: Satellite-based service available through a subscription
- Uncorrected: No GNSS corrections
- Ext. Corrections: tap when using corrections from an external correction source.

Frequency and baud rate

When receiving satellite signals, you must tap the frequency and baud rate based on your specific region:

- Western North America (RTX WN): 1557.8615 MHz at 600 baud
- Central North America (RTX CN): 1557.8150 MHz at 2400 baud
- Eastern North America (RTX EN): 1557.8590 MHz at 600 baud

- South/Central America (RTX SA): 1539.8325 MHz at 600 baud
- Europe/Africa (RTX EA): 1539.9525 MHz at 600 baud
- Asia Pacific (RTX AP): 1539.8325 MHz at 600 baud

Note – These frequencies do change occasionally. If you experience issues with the satellite signal, contact your reseller for updated satellite information.

xFill technology

During RTK signal interruptions, xFill™ technology can sustain RTK system operation for up to 20 minutes. xFill technology automatically turns on when the RTK signal is interrupted.

Correction services setup

Before you can use correction services that you have subscribed to, you must "unlock" them. See [Unlock / Upgrade, 195](#) for instructions.

CenterPoint RTX

To set the correction type to CenterPoint RTX:

1. At the *Settings* screen, tap **GNSS**. The *GNSS* screen displays.
2. Tap **GNSS Setup** and then tap **RTK**. The *GNSS Correction Source* screen displays.
3. Tap the appropriate option:
 - CenterPoint RTX (ss): Standard satellite
 - CenterPoint RTX (sc): Standard cellular
 - CenterPoint RTX (fs): Fast satellite
 - CenterPoint RTX (fc): Fast cellular
4. The *CenterPoint RTX Setup* wizard displays. Read all cautions and warnings carefully. Complete the appropriate settings.

Setting	Explanation
Satellite Settings	There is no need to change any settings on this screen unless the CenterPoint RTX broadcast frequency has changed.

Setting	Explanation
Position Quality	<p>Options that enable you to operate when the quality of GNSS position information is compromised.</p> <ul style="list-style-type: none"> • Favor Accuracy: Provides the highest level of accuracy. This is the recommended setting. • Balanced Quality: Trades potential accuracy for a slight increase in production time. • Favor Availability: Extends production time further, with more potential for reduced accuracy.
Threshold for CenterPoint RTX (s) Favor Accuracy	<p>The value at which the system will enable you to start guidance operations.</p> <ul style="list-style-type: none"> • For broad acre applications, enter a high number. • For row crop applications, enter a low number. <p>The current maximum value is 11 inches.</p>
FastRestart	<p>Reduces the time for the position to converge so that the system is ready for operation faster.</p> <ul style="list-style-type: none"> • When the vehicle will be parked in an area with a clear view of the sky when not in use, tap <i>On</i>. • If there is not be a clear view of the sky when not in use, tap <i>Off</i>.

5. At the *Frequency* tab, the frequency and baud rate are pre-selected for the US Central beam. If necessary, these values can be changed manually to track a specific Lband satellite.

(See Frequency and Baud rate in [GNSS setup, 166](#).)

6. After the wizard has been completed, return to the *Guidance* screen.

Example



At first:

- Convergence is a high value.
- The satellite icon is yellow, indicating the system is not ready to operate.

When the receiver converges to its final accuracy, the status values will change:

- Convergence has changed to the value you set in the *Threshold for CenterPoint RTX (s) Favor Accuracy* screen of the wizard. In this example, the threshold was set to 11 inches.
- The satellite icon is now green, indicating that the system is now ready to operate.

Renew CenterPoint RTX subscription

To renew your CenterPoint RTX subscription:

1. Ensure your Frequency and Baud Rate is already set up. (See Frequency and Baud rate in [GNSS setup, 166.](#))
2. Call Trimble Positioning Services.
3. Request a renewal of your subscription.

RangePoint RTX

To set the correction type to RangePoint RTX:

1. At the *Settings* screen, tap **GNSS**.
2. Tap **GNSS Setup**, then tap **RangePoint RTX**. Tap .
3. At the *Satellite Settings* screen, the frequency and baud rate are pre-selected for the US Central beam. If necessary, you can change these values to track a specific Lband satellite. (See Frequency and Baud rate in [GNSS setup, 166.](#))

Note – Verify on this screen that a subscription for RangePoint RTX is active.

4. At the *Position Quality* screen are options that enable you to operate even when the quality of

GNSS position information is compromised. Options for position quality are:

- Favor Accuracy: Provides the highest level of accuracy. This is the recommended setting.
- Balanced Quality: Trades potential accuracy for a slight increase in production time.
- Favor Availability: Extends production time further, with more potential for reduced accuracy

Example

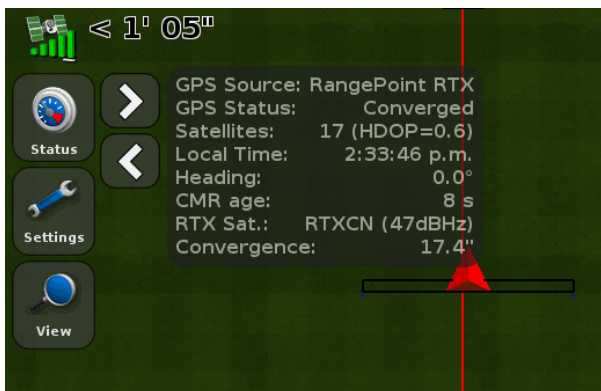

At first:

- Convergence is a high value.
- The satellite icon is yellow, indicating the system is not ready to operate.

When the receiver converges to its final accuracy, the status values will change:

- Convergence takes place in less than 5 minutes.
- The satellite icon is now green, indicating that the system is now ready to operate.



Renew RangePoint RTX subscription



To renew your RangePoint RTX subscription:

1. Ensure your Frequency and Baud Rate is already set up. (See Frequency and Baud rate in [GNSS setup, 166.](#))
2. Call Trimble Positioning Services.
3. Request a renewal of your subscription.

VRS

Note – To set up VRS, the display must be unlocked for RTK to use the Trimble VRS correction type. To use VRS, you must have a DCM-300 modem connected. See [DCM-300 modem setup, 179.](#)

1. At the *Guidance* screen, tap .
2. At the *Settings* screen, tap .
3. At the *GNSS* screen, tap **GNSS Setup**.
4. At the *GNSS Setup* screen, tap **GNSS Correction Source**.

5. At the *GNSS Correction Source* screen, tap **RTK**.
6. At the *Correction Delivery* screen tap **Trimble VRS Modem**, and then tap .
7. At the *Device Selection* screen, tap **DCM300**, then tap .
8. Connect the modem and turn it on.
9. Select the required Trimble modem and follow the on-screen instructions.
10. The first screen in the VRS setup wizard is *Wireless Modem Setup*. This is required only for Trimble modems if you installed a SIM card.

The SIM card provider is responsible for providing settings required.

Wireless Modem Settings	Explanation
APN	Mobile Network Access Point Name, usually required by the network
GPRS User Name	Mobile Network User name, optional setting . Check with your mobile network if this setting is required
GPRS Password	Mobile Network Password, optional setting. Check with your mobile network if this setting is required
CPIN	SIM PIN: Optional password lock to restrict use of the SIM card

11. Complete the next steps in the wizard. Enter the VRS settings provided by your Trimble CenterPoint™ or network RTK provider.

Internet Base Settings	Explanation
Server Name/Address	RTK/VRS/CORS base station broadcast name
Server Port Number	Server Port Number
Mount Point	Base station mount point
VRS User Name	Network Assigned username
VRS Password	Network Assigned password

12. After you have completed the wizard, the *VRS Status* screen shows the VRS connection status and all the settings entered.

VRS Connection Status	Explanation
Logged in	VRS connected
Connecting	Mobile network - Searching
Disconnected	Mobile network - No service

Position quality

GNSS signals can be disrupted by foliage, or when the machine moves out of sight of one or more satellites, or when one or more satellites move out of sight of the machine or 'set' below the horizon.

The *Position Quality* screen provides options that allow you to operate when the quality of GNSS position information is compromised. Options are:

- Favor Accuracy: Provides the highest level of accuracy
- Balanced Quality: Trades potential accuracy for a slight increase in production time
- Favor Availability: Extends production time further, with more potential for reduced accuracy

GNSS advanced settings

At the *Advanced* screen, you can view and adjust advanced GNSS settings.

Setting	Explanation
Antenna Type	<p>At the <i>Antenna Type</i> screen, change the internal settings of the GNSS receiver to ensure optimum accuracy for the antenna.</p> <p>Select the antenna you have connected to the display.</p> <p>Note – <i>The AG-25 antenna is white and dome shaped.</i></p>
Use SBAS satellites in the position fix	<p>Choose this option if you want to use SBAS corrections from WAAS satellites to calculate the GNSS positions. For example, if the display receives position information from six standard GNSS satellites and two WAAS satellites, the display uses all eight satellites to calculate the GNSS position.</p> <p>This can extend operating time when limited number of satellites are available.</p> <p>Note – <i>This option does not work with EGNOS satellites, OmniSTAR, or RTK corrections.</i></p>

Setting	Explanation
Force GNSS Iono	Force GNSS Iono setting is primarily for locations at the edge of SBAS coverage, such as northern Canada. It could affect accuracy if used elsewhere. Tap On to force the use of modeled rather than real-time ionosphere data.
Satellite Health	Use this setting to disregard signals from a specific satellite due to concerns about its state. For more information, contact your reseller.

GNSS status

At the *Status* screen, you can access:

- [GNSS Status](#)
- [Satellite Status](#)
- [DGPS Status](#)

GNSS Status

The *GNSS Status* screen displays information about your position and the current strength of the GNSS signal.

Satellite Status

The *Satellite Status* screen displays information about the current satellite constellation.

The information for each satellite is contained in one line. The meanings of the abbreviation are:

- Sv: Satellite number (GLONASS satellites have an "R" in front of the satellite number; GNSS satellites do not.)
- El: Elevation
- Az: Azimuth
- L1: L1 SNR
- L2: L2 SNR
- Corr: Correction (included only if correction is applied)
- Used: Used (included only if the satellite is used in position calculation)

DGPS Status

The *DGPS Status* screen displays which DGPS signal is selected from the *GNSS Correction Source* screen. For more information, see [GNSS status, 174](#).

Data

In this chapter:

Data management	178
Data transfer	178
DCM-300 modem setup	179
Office Sync setup	180
Manual wireless transfer with Office Sync	182
USB drive data transfer	183
Clear display's internal memory	185

You can manage data by saving configurations and transferring data wirelessly or through a USB drive.

Data management

As part of data management, you can:

- Save or restore a completed vehicle configuration file (see [Save or restore vehicle configuration file, 84](#))
- Save implement, lightbar and other settings (see Save/Load Configurations in [Advanced display settings, 192](#))
- Export yield data to a USB drive
- Send fields (using Office Sync) to your home or office computer
- Delete fields, coverage logging and yield data
- Export diagnostic log files to the USB drive for technical support purposes
- Copy prescriptions from the USB drive to the internal memory and delete from the USB drive

The CFX-750 display stores client, farm, field, and event data in a specific structure on the computer and USB drive. The first level folder is AgGPS.

Data transfer

You have two options to transfer data between the CFX-750 display and the office:

- Using a USB drive (see [USB drive data transfer, 183](#))
- [Wirelessly](#) using Office Sync, which requires:
 - A DCM-300 modem (see [DCM-300 modem setup, 179](#))
 - An Office Sync subscription and setup (see [Office Sync setup, 180](#))

Transfer data wirelessly

Office Sync is a subscription feature you can purchase. Using Office Sync, you can wirelessly transfer data from the CFX-750 display to the office, including but not limited to:



- Event coverage
- Field boundaries
- Guidance lines
- Yield data
- Area, line and point features

Note – *Office Sync requires a subscription. For more information on purchasing a subscription, contact a Trimble reseller.*

Wireless transfer can occur:

- Automatically (see [Office Sync setup, 180](#) for automatic settings)
- Manually (see [Manual wireless transfer with Office Sync, 182](#))

To access the *Data* screen:

1. At the *Guidance* screen, tap .
2. At the *Settings* screen, tap .

DCM-300 modem setup

A DCM-300 modem is required to:

- Use VRS™ corrections. (See [Correction services setup, 168.](#))
- Send data wirelessly from the CFX-750 display to the office using Office Sync.



Passcodes



To use VRS corrections and Office Sync, the DCM-300 modem requires a passcode upgrade.

Unlock DCM-300 modem

To begin using VRS corrections or transferring data, VRS and Sync File Transfer functions in the DCM-300 modem must be unlocked.

To unlock the modem with a passcode, first obtain the unlock code from your Trimble reseller.

1. Turn on the modem.
2. Connect the modem to the USB port on the CFX-750 display.
3. At the *Guidance* screen, tap .
4. At the *Settings* screen, tap .
5. At the *System* screen, tap **Unlock/Upgrade**.
6. At the *Unlock/Upgrade* screen, tap **Unlock DCM-300**.
7. At the *Enter Lockcode* screen, enter the passcode. Tap .
8. When the display asks if you want to restart the modem, tap **Yes**.

9. The *Unlock DCM300* screen displays. Tap . The DCM-300 modem will be ready to use after about three minutes.
10. To check the status of the modem unlock:
 - a. At the *Guidance* screen, tap .
 - b. At the *Settings* screen, tap .
 - c. At the *System* screen, tap **Status**.
 - d. At the *Status* screen, tap **Upgrade Options**.

DCM-300 Upgrade Option	Explanation
Firmware Version	Current version of firmware
Cellular Parameter Modification	Needed for DCM-300G modem when the customer supplies their own SIM card
File Transfer, VRS, Internet, and WiFi	Required for the use of VRS or Office Sync functions

Office Sync setup

With the Office Sync feature, the CFX-750 display can wirelessly send field information from the display to your home or office computer. This can occur either automatically or when you manually choose to start the transfer.

Note – To use Office Sync, see [Office Sync operation, 255](#).

Note – Obtain the subscription for Office Sync from your Trimble reseller prior to setup.

Requirements

Requirements for exchanging data electronically include the following:

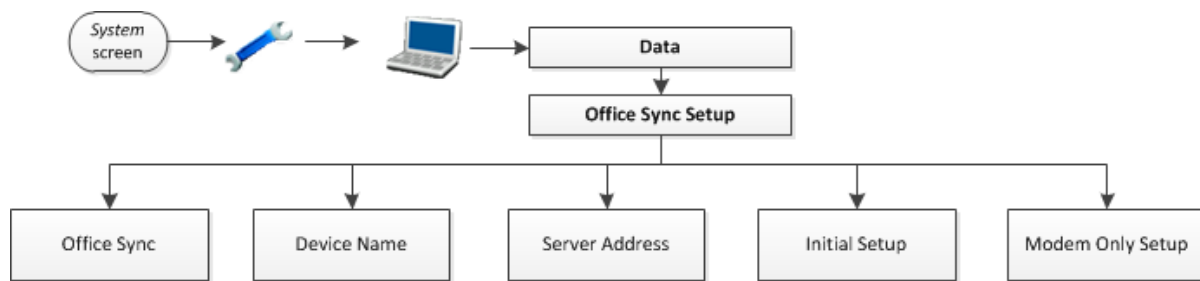

- A configured modem (see [DCM-300 modem setup, 179](#))
- A Connected Farm account
- A data plan or access to WiFi
- Office Sync configured on the display to communicate with your Connected Farm storage area



Office Sync and Initial Setup

The Initial Setup wizard steps you through the process of setting up your wireless modem and registering the network.

By default, the Office Sync feature is set to *Off*. To turn the feature on:

1. At the *System* screen, tap .
2. At the *Settings* screen, tap .
3. At the *Data* screen, tap **Office Sync Setup**.
4. At the *Office Sync Setup* screen, tap **Office Sync**.
5. At the *Office Sync* screen, tap **On**. This causes the *Office Sync Setup* screen to display.

Note – When you turn the Office Sync option On, tapping Office Sync Setup takes you directly to the Office Sync Setup screen.

Note – If you turn off this setting, all wireless transfer of data will stop.

Device name

The device name is a way to identify the display for customers using FarmWorks office software.

In Connected Farm the display must be associated to a vehicle, and the vehicle is used for identification.

Server Address



This setting controls communication with the Connected Farm server.

Note – This setting should only be changed if advised by Trimble Support. Modifying this setting could result in lack of operation of the Office Sync functionality. If this setting is modified or lost, please restore default settings to regain functionality.

Modem only setup

This wizard steps you through the setup of DCM-300 configuration options. A DCM-300 modem must be connected to run this wizard.



Use this option to set up your wireless modem.



1. Connect the modem. The *Modem Detected* screen displays.
2. Tap  to attempt to connect to the network.
3. At the *Wireless Modem Setup* screen, you can enter or change:
 - APN/Setup String
 - SIM PIN
 - Network username: change the username used for network registration.
 - Network password: change the password used for network registration.
4. After you set up your modem, the *Network Operational* screen displays to indicate setup is successful. Tap  to continue with the process of registering with the Office Sync network.

Note – The internal settings for your modem are on the SIM card that your modem uses. For further setup information, contact your SIM card provider.

Manual wireless transfer with Office Sync

To manually transfer field events wirelessly:

1. Tap  to go to the *Settings* screen.
2. Tap  to go to the *Data* screen.
3. At the *Data* screen, tap **Manage Data**.
4. At the *Manage Data* screen, tap **Office Sync**.
5. To receive data wirelessly from the office, at the *Office Sync* screen:
 - a. Tap **Manage Data**.
 - b. At the *Manage Data* screen, tap **Office Sync**.
 - c. At the *Office Sync* screen, tap **Retrieve Data**.
 - d. At the *Retrieve Data* screen, tap **Check Server** to check for and download new field data.
 - e. After the data is downloaded, tap **Get Fields from Office Sync Server** at the *Retrieve Data* screen to import the data into the display.

6. To send data wirelessly from the office, at the *Office Sync* screen:
 - a. Tap **Manage Data**.
 - b. At the *Manage Data* screen, tap **Office Sync**.
 - c. At the *Office Sync* screen, tap **Send Data**.
 - d. At the *Send Data* screen, tap **Send Fields to Office Sync**.
 - e. At the *Send Fields to Office Sync* screen, you can choose which data to transfer. After you tap , the system displays indicating any open fields will be closed before the data transfer occurs. If you want to continue, tap .

USB drive data transfer

You can use a USB drive to transfer field data, including:

- Field boundaries
- Point, line and area features
- Guidance lines
- Event data (coverage)
- Prescriptions

From the internal memory to the USB drive, you can transfer:

- Autopilot information
- Prescriptions
- Client, farm and yield data

USB drive compatibility

You can use these USB drives with the CFX-750 display:

- A-Data micro SDHC/SD/USB adapter
- ADATA Classic C801 8 GB
- Digital Concepts USB to PC Reader
- Generic USB - uDHC adapter with Transcend 8 GB microSDHC card
- Kingston Data Traveler 8 GB
- Kingston Data Traveler 101
- Lexar Firefly 1 GB
- Lexar JumpDrive TwistTurn

- Lexar Secure II Plus
- PNY Attache
- PNY Micro Swivel Attache 4 GB
- PNY Mini Attache 4 GB
- PNY Mini Attache 8 GB
- SanDisk Cruzer
- SanDisk Cruzer Gator 4 GB
- SanDisk Cruzer Micro 1 GB
- Toshiba TransMemory U2M-004GTA 4 GB
- Transcend JetFlash

Insert a USB drive

1. View the back of the display.
2. Insert the USB drive into the USB socket. When the USB drive is inserted correctly, the USB icon displays on the *Guidance* screen.

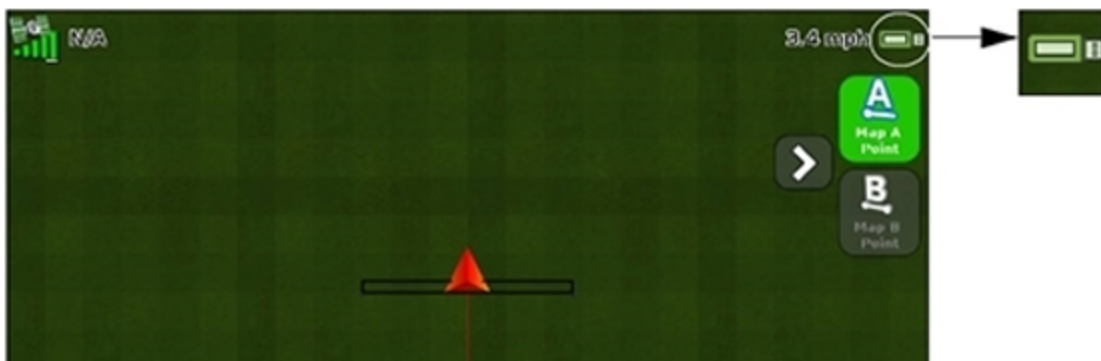

The color of the USB icon indicates the current state of the USB drive:

- Green: Connected
- Yellow: USB drive is connecting
- Red: No connection



Remove a USB drive

⚠ CAUTION – Do not remove the USB drive from the socket while the display is writing to or from the drive. This will corrupt the data.

1. View the back of the display.
2. Pull the USB drive out of the USB socket.

Retrieve or send data using the USB drive

Note – You cannot send data to a USB drive that is over 90% full.

1. Tap  to go to the *Settings* screen.
2. Tap  to go to the *Data* screen.
3. At the *Data* screen, tap **Manage Data**.
4. At the *Manage Data* screen, tap **USB**.
5. To receive data from the USB drive, at the *USB* screen:
 - a. Tap **Retrieve Data**.
 - b. At the *Retrieve Data* screen, tap **Get Fields from USB**.
6. To send data to the USB drive, at the *USB* screen:
 - a. Tap **Send Data**.
 - b. At the *Send Data* screen, tap **Export Diagnostic Logs to USB**.

Clear display's internal memory

Over time, the internal memory of the CFX-750 display may become full. To avoid this, delete files that you no longer need.

To delete files:

1. At the *Manage Data* screen, tap **Internal** and then **Delete Data**.
2. Select the information to delete and then follow the wizard steps until the files are deleted.

Note – If a field is currently open it will close prior to the deletion.

System settings

In this chapter:

System settings	188
Quick start wizard	188
Display settings	189
Advanced display settings	192
Unlock / Upgrade	195
Status	196
About the display	198
Restore defaults	198
Recalibrate touchscreen	198

The system settings include:



- Customizing the display for language, units of measure, time zone and other items
- Unlocking features or updating firmware
- Showing the status of the display
- Recalibrating the touchscreen

System settings

The *System* menu enables you access system settings, including:

- [Quick start wizard, 188](#)
- [Display settings, 189](#)
- [Advanced display settings, 192](#)
- [EZ-Remote Joystick custom settings, 86](#)
- [Unlock / Upgrade, 195](#)
- [Status, 196](#)
- [Restore defaults, 198](#)
- [Recalibrate touchscreen, 198](#)

To access the *System* screen:



1. At the *Guidance* screen, tap .
2. At the *Settings* screen, tap .

Quick start wizard

With the *Quick Start Wizard*, you can configure settings before you begin driving. The first time you turn on the display, the wizard starts automatically. Make sure that when you first turn on the display that you complete all steps of the wizard.

When you use the wizard, you can choose whether or not it starts every time the display is turned on. If you choose to hide the wizard, the *Guidance* screen will display automatically when you turn the unit on again.

To access the wizard at a later time:

1. At the *Guidance* screen, tap .
2. At the *Settings* screen, tap .
3. Tap **Quick Start Wizard**. The *Welcome* screen displays.
4. Tap . The *Units* screen displays.
5. To set up your system, complete each screen of the wizard.

Display settings

At the *Display* screen, you can adjust the settings for the CFX-750 display, including:

- [Units](#)
- [Language](#)
- [Color Scheme](#)
- [Time Zone](#)
- [View](#)
- [Status Popup Transparency](#)
- [Backlight](#)
- [Touchscreen beeper volume](#)
- [Alert Beeper](#)
- [Lightbar setup](#)

Units

The CFX-750 display can display in either US/Imperial or Metric format:

- Unit: Inches, feet, miles, or centimeters, meters, kilometers
- Speed: Miles or kilometers per hour
- Area: Acres or hectares

Color Scheme

Adjust the color scheme of the CFX-750 display according to the cab lighting and time of day. (See also [Backlight, 190.](#))

Setting	Works best for...
Day (default)	A brightly lit environment.
Dimmed (low light)	Dark and low cab light environments
Red (low light)	Dark and low cab light environments

Time Zone

The GNSS receiver provides UTC (formerly GMT) time. To display and log times in your local time, set the time zone offset.

Location	Standard Time Offset	
US Eastern Time	-5:00	-4:00
US Central	-6:00	-5:00
US Mountain	-7:00	-6:00
Australia East	+10:00	-11:00 (excludes QLD)
Australia Central	+9:30	+10:30 (excludes NT)
Australia West	+8:00	+8:00

View

The view you see on the *Guidance* screen can be an overhead view or trailing view, and can be changed automatically or manually.

- Auto Headland: The view automatically changes between overhead view (in headlands) and trailing view (on swaths).
- Auto Engage: The view automatically changes between overhead view (not engaged) and trailing view (engaged).
- Manual: You must manually change between overhead and trailing view.

Status Popup Transparency

The transparency of the status popup ranges from 1 to 10:

- 10: Tab is completely solid
- 1: Tab is barely visible

Backlight

To maximize visibility and reduce glare in different light conditions, you can adjust the brightness of the screen backlight within a range of 1 to 20:

- 20: Backlight is at maximum brightness
- 1: Backlight is at minimum brightness

Alert Beeper

The CFX-750 display will sound an alert in certain situations. You can set the system to use:

- Internal speaker loud: Speaker of the CFX-750 display at a loud setting
- Internal speaker quiet: Speaker of the CFX-750 display at a quiet setting
- External speaker (sonalert): External speaker such as Sonalert

Touchscreen beeper volume

When you tap buttons on the touchscreen, the CFX-750 display beeper can be:

- Loud
- Quiet
- Off (silent)

Lightbar Setup

Setting	Description
Look Ahead	<p>Allow time for large vehicles to correct offline error:</p> <ul style="list-style-type: none"> • For large vehicles that take longer to turn, increase the look ahead time. • For 4WD articulated tractors, always set the look ahead time to 0 seconds. <p>Look ahead time applies to LED guidance only and does not affect EZ-Steer performance.</p> <p>Set the look ahead time in seconds.</p>
LED Spacing	<p>Adjust the sensitivity of the LEDs. To:</p> <ul style="list-style-type: none"> • Increase sensitivity, decrease the LED spacing • Decrease sensitivity, increase the LED spacing
LED Brightness	<p>Adjust the LED brightness for maximum visibility. Maximum = 100, minimum = 0 (off).</p>

Setting	Description
Main Lightbar LED Mode	<p>Select the required LED mode. There are two modes to choose from:</p> <ul style="list-style-type: none"> • Chase: Chase the lights to stay online. The lights represent the swath location relative to the vehicle. • Pull: Center the lights to stay online. The lights represent the vehicle location relative to the swath.

Advanced display settings

At the *Advanced* screen, you can view and adjust:

- [Save/Load Configuration](#)
- [Digital Output](#)
- [Enable and access Advanced User Configuration](#)
- [Advanced User Config](#)
- [NMEA Output](#)

Save/Load Configurations

After you set up your display for your current job, you can save the settings to a configuration file. Saving a system configuration can be useful for:

- Quick setup when moving the display between vehicles or when using the same vehicle but changing the implement or application
- Tuning the settings for improved performance and saving your improved settings
- Restoring known good settings if unwanted adjustments have been made

Setting	Explanation
Load a Configuration	Load a configuration from internal memory or a USB drive.
Save Current Configuration	Save the current configuration to internal memory or a USB drive.
Delete a Configuration	Delete a configuration.

Note – If you tap **PreUpgradeConfig**, all settings are changed back to settings before your last upgrade.

Digital Output

The CFX-750 display can generate a digital signal on pin 2 of Port A.

Note – Additional equipment may be required to properly use the Digital Output function. To use speed pulse output, you need a radar sensor cable kit that includes a pulse amplifier adapter. Contact your local reseller.

Setting	Explanation
Disabled	Tap to turn digital output on or off. When disabled, digital output on pin 2 of Port A is off.
Radar	Output simulated radar pulses at a pre-defined speed pulse output rate. This can be useful to: <ul style="list-style-type: none"> • Replace the radar/true ground speed sensor for speed on the vehicle • Send speed to any other agricultural device requiring speed pulses, such as a yield monitor or variable rate controller. After you select Radar, set the radar frequency rate from the <i>Digital Output</i> screen.
Remote Output	Output a signal whenever auto steering is engaged. This can be useful to drive a switch or relay for equipment that should be active when engaged.

Advanced User Config



CAUTION – Do not use the Enable Advanced User Config feature unless you have the support of a Trimble Reseller. Altering any of the settings for this feature may cause system failure.

To enable Advanced User Config, tap **Enable Advanced User Config**, then tap **On** and .

When advanced user configuration is available, the following additional settings can be accessed.

- Advanced Port Setup: Settings for Serial Port A and B
 - Input protocol
 - Output protocol
 - Baud rate
 - Data bits
 - Data parity
 - Stop bits
- Hardware Tests: Motor test
- Mapping: Set data dictionaries to default
- Clear All Passcodes: Removes all subscriptions

- Position Rate: 10 or 5 Hz
- Screen Cursor: On or off. On displays a cursor (target) icon where you tap.
- File Maintenance

Option	Explanation
Internal File System Statistics	<p>You can view how much space is being used by specific files and features:</p> <ul style="list-style-type: none"> • Disk capacity • Disk space used • Percent of disk Used • Space used by Configuration files • Space used by Yield Monitoring • Space used by Field Data • Space used by Prescriptions • Space used by Autopilot/EZ-Pilot/EZ-Steer • Spaced used by log files • Space used by miscellaneous files
Delete a Configuration	<p>PreUnlockConfig PreUpgradeConfig</p>
Load Details	Details for Yield Monitoring loads
Delete a Vehicle Configuration	You can delete an auto guidance configuration from internal memory
Soft Reset	Performs a soft reset, removing your configuration and closing open fields
Hard Reset	<p>Performs a hard reset, removing all configuration, Yield Monitoring, coverage, field data, prescriptions and log data.</p> <p>Note – Back up your data on a USB drive to prevent data loss before performing a hard reset.</p>

NMEA Output

NMEA (National Marine Electronics Association) messages are a standard format that GNSS devices use to communicate. The CFX-750 display can output NMEA messages to communicate with other NMEA-compatible devices.

1. At the *Port Parameters* screen, specify:
 - NMEA output port: The port that the NMEA device is connected to
 - Baud Rate: The transmit/receive rate of the serial port in bits per second (bps)
 - Data Parity: How the parity bit is added to the data transfer (none, odd, even)



Note – For the CFX-750 display to communicate with another device, the Port Parameters on the display must match those of the device.
2. At the *Message Selection* screen, choose which NMEA message you want output:
 - GGA: Position and fix related data
 - VTG: Speed and heading
 - GSA: Position fix mode, satellites used and the dilution of precision (DOPs)
 - GLL: Position and status
 - RMC: Status, position, speed over ground (SOG) and magnetic variation of the position
 - ZDA: Date and time
 - GSV: Satellite information

Unlock / Upgrade

At the *Unlock/Upgrade* screen, you can:

- Unlock features, such as the Field-IQ crop input control system, using:
 - [The display screens](#)
 - [A USB drive](#)
- [Upgrade your display](#) to a newer firmware version

Unlock features using screens

1. Obtain the unlock code from your Trimble reseller.
2. From the *Guidance* screen, tap .
3. From the *Settings* screen, tap .
4. At the *System* screen, tap **Unlock/Upgrade**.
5. At the *Unlock/Upgrade* screen, tap **Password Upgrade**. The *Enter password* screen displays.
6. Use the virtual keyboard to enter the password.

Note – Ensure that you include dashes where necessary.

After you have entered a valid passcode:

- The display automatically restarts. **Do not** disconnect the power from the display while it is rebooting.
- The *Password Upgrade* screen displays again with a message that the upgrade was successful. If you have entered an incorrect password, an error message displays and you are returned to the *Unlock/Upgrade* screen.

Unlock features using USB drive

1. Obtain the unlock code from your Trimble reseller.
2. Create a ".txt" file on the root of the USB drive named "trimble_unlocks_" followed by the serial number of the display. For example: trimble_unlocks_5016500025.txt
3. Copy the passcodes into the .txt file you created in Step 2 and save the file.
4. Go to the *Guidance* screen and tap  in the upper right of the display.
5. Tap **Install Unlocks from File** and follow the steps in the unlock wizard.
6. After installation, a listing of accepted unlocks will be shown. Then the system will reboot.

Upgrade your display's firmware

1. Transfer the new firmware file from www.trimble.com to your office computer.
2. Connect the USB drive to your office computer.
3. Unzip the firmware file and then save it to the root folder of the USB drive.
4. Insert the USB drive into the USB socket of the display.
5. At the *Unlock/Upgrade* screen, tap **Firmware Upgrade Wizard**.
6. Select the file to upload and then tap . The firmware begins to load.

After the new firmware has successfully loaded, the display automatically restarts. **Do not** disconnect the power from the display while it is rebooting.

Status

At the *Status* screen, you can view the current status of the system.

Note – The items that display in the *Status* screen vary according to the features that you use.

Tap...	To view...
Language Pack status	The language packs that have been installed on the display

Tap...	To view...
LB25 remote lightbar status	<ul style="list-style-type: none"> • Status: Connected or Disconnected • Serial number • Firmware version
EZ-Remote status	<ul style="list-style-type: none"> • Status: Connected or Disconnected • Serial number • Firmware version
System status	<ul style="list-style-type: none"> • Current time and date • ID: CFX-750 • The following data about the CFX-750 display: <ul style="list-style-type: none"> • Version and Version date • Serial number • Part number • Hardware Revision • System voltage • Temperature <p>Storage: This is the number of hours of coverage logging remaining before the internal memory is full.</p> <p>Operational hours: This is the number of hours that the CFX-750 display has been operating.</p>
Upgrade options	<p>Status of optional features and subscriptions:</p> <ul style="list-style-type: none"> • Unlocks: List of all features that have been unlocked • Subscriptions: List of all subscriptions • Region Protect: The GNSS signal region you are currently in and whether it is locked or unlocked <p>Note – <i>If your region is locked, contact your Trimble reseller.</i></p>
Fault history	Faults that have occurred recently (they may not be currently active)

Tap...	To view...
Internal File System Statistics	<p>You can view how much space is being used by specific files and features:</p> <ul style="list-style-type: none"> • Disk capacity • Disk space used • Percent of disk Used • Space used by Configuration files • Space used by Yield Monitoring • Space used by Field Data • Space used by Prescriptions • Space used by Autopilot/EZ-Pilot/EZ-Steer • Spaced used by log files • Space used by miscellaneous files

About the display

The *About the Display* screen lists the:

- ID of the display
- Version of the firmware
- Version Date of the firmware
- Serial number of the display
- Part Number of the display
- Monitor Version of the display

Restore defaults

Restores the display defaults to clear all of your current settings. If you choose to restore the default settings, the display and lightbar will restart.

Recalibrate touchscreen

The first time you power on the display, you must calibrate the touchscreen.

If the current calibration does not read your selections accurately, use the *Recalibrate Touchscreen* option to adjust the responsiveness of the touchscreen.

Otherwise:

1. Power off the display and then power it on.
2. Wait until the status bar at the bottom of the second startup screen is lighted more than 50%.



3. Press **both** brightness control buttons at the same time.



4. Hold the two buttons down until the display beeps.

Operations

In this chapter:

Map guidance and features	202
Fields	217
Auto steering system operation	219
Field-IQ operation	230
Operate implement controllers	238
Boom Height Control operation	243
Yield Monitoring operation	250
Office Sync operation	255

This chapter covers tasks related to field operations.

Map guidance and features

To receive guidance information (and any assistance from an auto steer system) you must:

- Configure how the guidance displays on your screen. See [Guidance settings, 146](#).
- Map a guidance line. See [Guidance line / pattern mapping, 203](#).
- Set up the lightbar. See Lightbar setup in [Display settings, 189](#).

On the CFX-750 display, you can create:

- Guidance lines and patterns (such as headlands and pivots)
- Features (such as trees, rocks and areas) (see [Feature mapping buttons, 215](#))

To create a guidance line, you define a start point (A) and an end point (B). After you define the A and B points, the display draws a line between them. This is the master AB line.

Note – *AB lines are stored automatically. You do not have to actively save an AB line.*

When you define the first guidance line, the display copies it to create additional guidance lines.

Patterns you can create include:

- Headland
- Pivot

While you work, guidance information displays on the CFX-750 display screen and the integrated lightbar that indicate the:

- Position of your vehicle in the field
- Guidance lines
- Offline distance

Distance between guidance lines





When you define the AB line, you specify the width of the implement that is attached to the vehicle. The display uses this measurement to calculate the distance between the guidance lines. If you do not want the guidance lines to be exactly one implement width apart, you can set an overlap or skip.

Headlands

You can record a headland boundary, or you can work without a headland.

On-screen appearance

When the *Guidance* screen shows the trailing view, it labels the guidance lines with icons.

Icon(s)	Are tagged to...
	The master line that you created. The swaths are based on this line.
 	The A (start) and B (end) point on the master line.
	The first swath to the left of the master line. 'Left' is relative to the direction the master line was drawn, not the vehicle's current position. <ul style="list-style-type: none"> The current swath and tag are orange. On a Pivot pattern, the swaths are numbered out from the center, not from the initial swath.
	The second line to the left of the master line.

Guidance line / pattern mapping

1. Select a guidance pattern that enables you to create a guidance line to suit your field.
2. From the *Guidance* screen, tap .
3. Tap **Create New Field**.
4. At the *Create New Field* screen, tap **Pattern Type**.
5. Tap the pattern to use.

If you...	Pattern to Use
Do not need to define headlands and you want to drive the field in parallel straight lines.	Straight AB
Need guidance exactly parallel to the last AB line. For example, when: <ul style="list-style-type: none"> Driving adjacent fields Mapping the AB line on a road down the side of the field Skipping an access road in a field 	A+ line
Want to work a field with gentle curves.	Identical curve

If you...	Pattern to Use
Want to work in a field that use center-pivot irrigation.	Pivot
Want to define the boundary (headland) of the area, as well as the guidance lines contained within it.	Headland
Want to: <ul style="list-style-type: none"> • Work in a field with variable terrain • Create a spiral into the center of the field • Create curved and straight lines of any shape 	Freeform

Straight AB

Use a straight AB line when you do not need to define headlands and you want to drive the field in parallel straight lines.

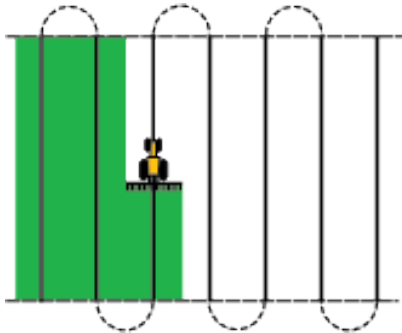

When the vehicle is on a guidance line, the line extends 1 km (0.6 miles) before point A and 1 km beyond point B. This makes it easier to see where the next swath is and to get online after a turn.

Map an AB line

Note – When driving on straight AB lines, you do not have to record your path because the guidance lines are generated automatically.

1. Drive to the start point of the master line.
2. Tap **A** and then drive to the end of the line.
3. When the icon is highlighted, tap **B**. The master AB line displays.
4. Turn left or right for the next swath. As you move toward the next swath, it displays on the screen and turns orange to show that it is selected.

A+ line

Note – When driving on straight AB lines, you do not have to record your path because the guidance lines are generated automatically.

An A+ line is a straight line, defined by a single A point on the line and the heading of the line. When you create an A+ line, you must enter a heading in the *A+ Heading* screen. By default, the A+ heading is the same as the previous AB line.

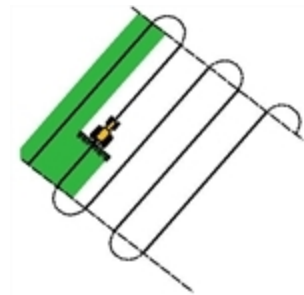

An A+ line is useful when you need guidance exactly parallel to the last AB line. For example, when:

- Driving adjacent fields
- Mapping the AB line on a road down the side of the field
- Skipping an access road in a field

The A+ line extends 1 km (0.6 miles) before and after the A point.

Map an A+ line

1. Drive to the start point of the master line.
2. Tap  and then drive to the end of the line. Because you have already set the line heading, the master AB line displays on the screen.
3. For guidance down the first swath follow the AB line.
4. Turn left or right for the next swath. As you move toward the next swath, it displays on the screen and turns orange to show that it is selected.

Identical curve

The identical curve pattern records your exact route between the A and B points, instead of creating a straight line. All subsequent guidance lines will match the master curve, regardless of where you drive the vehicle.

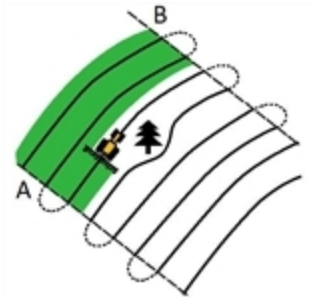

Use the identical curve pattern when you want to work a field with gentle curves.

Map an identical curve

1. Drive to the start point of the curve.
2. Tap **A** and then drive the initial curve.
3. When the icon is highlighted, tap **B**. The master curve displays on the screen.
4. Turn left or right for the next swath. As you move toward the next swath, it displays on the screen and turns orange to show that it is selected.

Adaptive curve

The adaptive curve pattern provides guidance along a curve and updates guidance after each swath to take into account any deviations you make. It continually records your path and provides guidance that matches the last path you drove.

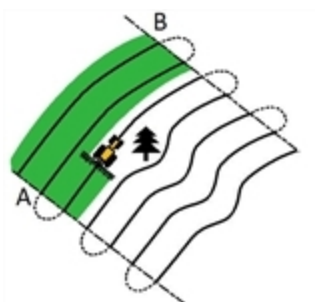

Map an adaptive curve

You can map an adaptive curve either manually or automatically. The method you use depends on the Auto U-turn detection setting.



Change the Auto U-turn detection setting

1. At the *Settings* screen, tap .
2. Tap **Turn Settings**, then **Auto U-Turn Detection**.
3. If you want to map the adaptive curve:
 - a. Automatically: Tap **On**.
 - b. Manually: Tap **Off**.

Map an adaptive curve with automatic turn detection

1. Drive to the start point of the curve.
2. Tap  and then drive the initial curve.
3. At the end of the first curve, perform a U-turn. The system detects the turn and generates the next swath.

Map an adaptive curve manually

1. Drive to the start point of the curve.
2. Tap  and then drive the initial curve.
3. At the end of the first curve, tap . The system generates the next swath.
4. Continue to drive the swaths, setting the B point at the end of each one.

Use the adaptive curve pattern for row-finding

1. Set Auto U-Turn Detection to **Off**.
2. Create a guidance line based on the adaptive curve pattern.
3. Set the B point at the end of each row.
4. Turn the vehicle toward the next swath. When the vehicle is halfway through the turn, guidance along the next swath displays.

Create straight sections on curve swaths

To create straight sections when recording curve swaths:

1. Tap .
2. Drive the section.

3. Tap  to finish recording the straight section and to start recording a curve again.

Pivot

Use the pivot pattern on fields that use center-pivot irrigation. With this pattern, you can drive concentric circles around the center-pivot.

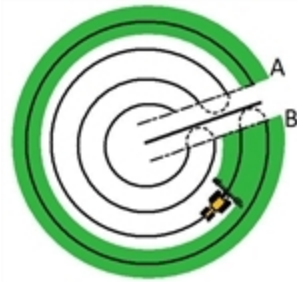

Map a pivot

Note – Always set the master line near the outer edge of the field.

1. Drive to the start point of the pivot.
2. Position one wheel of the vehicle in a pivot wheel rut, with the rear of the vehicle to the pivot arm. If the field is not a full circle pivot, face the rear of the vehicle to the edge of the field.
3. Tap  and then drive around the field. Keep the vehicle in the rut. The display will generate guidance swaths.
4. Turn left or right for the next swath. As you move toward the next swath, it displays on the screen and turns orange to show that it is selected.
5. Steer the vehicle so that the lighted LEDs are centered on the lightbar as you drive forward along the swath.

Headland

Two types of headland patterns enable you to define the boundary (headland) of the area, as well as the guidance lines contained within it. Use the headland pattern to allow room to turn.

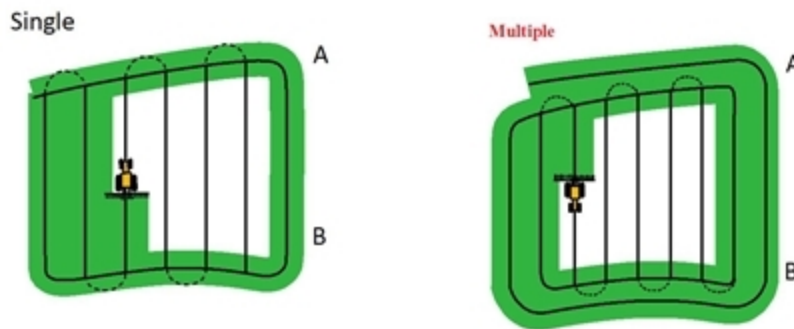

When you start to define the headland, you define the internal guidance line as you drive around the headland and then you complete the headland.

You can change two settings for the headland pattern:

- The number of circuits
- The internal pattern

Number of circuits

When you create a headland, you must specify the total number of circuits (including the master headland). This defines how wide the headland is.

No matter how many circuits you create, define only the outside headland. The inner headlands are copied from that original circuit.

Internal pattern

The internal pattern is the pattern of the guidance lines inside the headland. An internal pattern can be:

- Straight AB: Standard parallel swaths inside a headland
- A+: Parallel swaths at a pre-defined heading



Re-select the headland

When you use the headland pattern, you can see either the headland or the internal pattern.

To see the headland guidance again when you are driving the internal pattern, drive into the headland before the first internal swath or after the final internal swath. The headland displays automatically.

Map a headland

1. Drive to the start point of the headland.
2. Tap  to set the start point of the headland.
3. Begin to drive the circuit of the headland.

Note – To ensure straight sides on the headland, you can use the pause feature. See [Guidance line / pattern mapping, 203](#).
4. Tap  to set the A point of your guidance line. If the internal pattern is an:
 - A+ line, the line is set.
 - An AB Line, continue to drive around the headland. When you reach the other end of the internal guidance line, tap  to set the B point.

When you define the internal pattern guidance line, the start-point circle displays around the start point of the headland.

Note – If you return to the start of the headland before you define a guidance line, the headland will not complete.

5. Complete the headland.

Note – Define the master line for the internal pattern before you complete the headland.

To finish the headland, do either of these:



- Drive around the rest of the headland until you return to the start-point circle. When you drive into the start-point circle, the headland completes automatically.
- Drive part of the headland and then tap . The headland completes with a straight line from the vehicle position back to the start point.

After you complete the headland, the headland guidance line displays.

When the vehicle moves out of the headland and into the interior of the pattern, the interior is populated with your selected the guidance line pattern (straight AB or A+).

Create straight sections on Headland swaths

To create straight sections when recording headland swaths:

1. Tap .
2. Drive the section.
3. Tap  to finish recording the straight section and to start recording a curve again.

FreeForm

Use this pattern type to create curved and straight lines for guidance in fields of any shape.

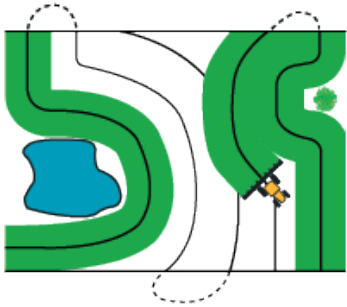



The display records the exact path you drive, and uses this to generate the next guidance line.

To select the FreeForm recording option:



1. At the *Settings* screen, tap **Guidance** and then **FreeForm Recording**.
2. Tap **Manual** or **Record with coverage**.

Record a FreeForm curve

1. Drive to the start point of the FreeForm curve.
2. To use:



- Manual recording, tap 
- Record with Coverage, tap either  or 

While the display is recording the current path,  displays on the *Guidance* screen.

3. Drive the curve. To record straight sections, you can use the pause feature. See [Guidance line / pattern mapping, 203](#).
4. To finish recording:
 - If Auto U-Turn Detection is on, perform a tight U-turn.
 - For Manual recording, tap .
 - If you are using Record with Coverage, tap  or .

Note – If Auto U-Turn Detection option is off, you must manually stop recording at the end of each pass and then start recording again at the beginning of the next pass.

Use the FreeForm pattern to define a straight AB line

1. Tap  and then drive to the end of the line.
2. At the end of the line, tap .

Switch to another line

To switch from the current FreeForm guidance line to another, tap .

The first time you tap the button, guidance snaps to the next nearest curve. Continue tapping the button to cycle through other guidance lines.

Note – To use this feature, the vehicle must be within 1.5 swath widths of a FreeForm curve.

Use FreeForm curves in spiral fields

If you are creating a spiral into the center of the field, drive the full circuit and then back onto the start of the FreeForm curve. Continue to record your guidance path as you spiral toward the center of the field.

If you encounter an obstacle in the field, continue to record your path as you drive around it. On the next pass the guidance line will adjust to reflect this.

Note – When you create a spiral with the FreeForm guidance pattern, there may be a space at the center of the spiral.

Use FreeForm curves in fields with variable terrain

Start and stop recording guidance at the ends of each pass. If there are two guidance lines in close proximity, tap  to snap to the correct line.

At any point you can add a straight AB line for repeated straight line guidance.

Tap  to switch between straight AB and FreeForm curve guidance lines.

Use guidance on curved segments

After you map a guidance line, there are two ways to get guidance:

- Drive the vehicle through a tight U-turn. The next guidance line displays.
- If you are manually logging a FreeForm curve, tap  to stop defining the current line.

The FreeForm curve is similar to an adaptive curve. You must record your line on each pass to receive guidance on the next. If the vehicle is not drawing a line (or guidance trail) behind it, you are not recording your path and therefore the next guidance line will not display.

Note – Do not confuse the existing guidance line with the guidance trail appearing behind the vehicle that shows your current guidance. You need to create a new guidance line to receive guidance on the next pass.

Pause / Resume guidance

When you tap  to pause guidance:

- An icon displays on the screen to show your exact location when the guidance was paused. This enables you to return to that position in the field.
- Your current position relative to  displays in the status bar at the top of the screen.
- The guidance line that you were on is displayed, even if you drive onto another swath.
- The system pause remembers the vehicle position, even when the lightbar is turned off.

Resetting guidance













1. To reset guidance, in the guidance view, tap . The *Finished with Field* screen displays.
2. To map a new:
 - Field or select an existing field, tap **Yes**.
Note – If you tap ‘Yes’, then the current field automatically closes. This means that you cannot cancel out of the New Field wizard and go back to your current field.
 - AB line or select an existing AB line in the current field, tap **No**.

Guidance mapping buttons

Tap  to open the mapping buttons for creating and adjusting guidance lines and patterns.









The buttons that display depend on the action you are performing.

Button	Function	Button	Function
	Pause guidance		Start recording headland
	Nudge left		Pause recording headland
	Nudge right		End headland recording
	Shift AB line		Set A point
	Shift By		Set B point
	Record FreeForm guidance pattern		Next AB line



Feature mapping buttons

Tap  to open the feature mapping buttons. You can map a line feature as well as set features (points) where there are trees, rocks or areas in your field.

Button	Feature Created	Button	Feature Created
	Map line feature		Map rock (point feature)
	Tree		Area
	Weed		Restricted area
	Delete feature		

Line Feature

With Line Feature Guidance, you can select a previously determined line feature to use as a guidance line.

1. After setting up an AB line (see [Feature mapping buttons, 215](#)), tap  and then tap .
2. Following the on-screen instructions, begin mapping the line.
3. Map as many lines as required.

Note – If you have already created lines using the Farm Works Software® or using another display, you can load these files. Select *Settings / Data / Manage Data / USB / Retrieve Data / Get files from USB*. Ensure that the files are loaded into the same directory as the field that is currently open.

4. Tap . The *Finished with Field* screen displays.
5. Tap **No**. The *Create new or select old swath* screen displays.
6. Tap **Line Feature Guidance**.

7. At the *Select Line Features or Swaths* screen, select the line or lines that were created/imported, or tap **Guide to All**.
8. At the *Confirm Implement* screen, confirm that the information is correct.
9. At the **Guidance** screen, the nearest selected line feature is now highlighted and can be used for guidance.

Fields

In the CFX-750 display, a “field” is specific area of land represented on your screen where events (such as planting seed or applying fertilizer) are carried out.

You create your first field in the display when you first configure your implement. That field remains open until you do any of these:

- Create a new field, or load a previously saved field.
- Calibrate your automatic steering system.
- Perform a hard reset.

Note – *Fields are stored automatically. You do not have to actively save a field.*

New field creation

1. At the *Guidance* screen, tap . The *Finished with Field* screen displays.
2. Tap **Yes**.
3. At the *Create New or Select Old Field* screen, tap **Create New Field**.
4. To setup the new field, continue through the wizard.
5. Follow the on screen instructions to drive your new line. See Map an AB line in [Guidance line / pattern mapping, 203](#).

Add an AB line to a current field

To create a new AB line in a current field:

1. At the *Guidance* screen, tap . The *Finished with Field* screen displays.
2. At the *Finished with Field* screen tap **No**.
3. At the *Create New or Select Old Swath* screen, tap **Add AB Line**.
4. Follow the on-screen instructions to drive your new line. (See Map an A+ line in [Guidance line / pattern mapping, 203](#).)

Load an AB line into a field

1. At the *Guidance* screen, tap . The *Finished with Field* screen displays.
2. At the *Finished with Field* screen tap **No**.
3. At the *Create New or Select Old Swath* screen, tap **Select Old**.
4. Follow the on-screen instructions to drive your new line.

Record keeping

Optionally, you can record operational and environmental information about each field that you create, including:

- Application method
- Applied material
- Crop
- EPA license number
- Farm location
- Harvest year
- Humidity
- Implement
- Operator
- Sky conditions
- Soil conditions
- Target pests
- Temperature
- Vehicle
- Wind direction
- Wind gust speed
- Wind speed

Additionally, there are four custom fields where you can enter your own values.

Auto steering system operation

To receive guidance information (and any assistance from an auto steer system) you must:

- Configure how the guidance displays on your screen. See [Auto steering system operation](#).
- Map a guidance line. See [Guidance line / pattern mapping, 203](#).
- Configure the lightbar. See Lightbar setup in [Display settings, 189](#).

EZ-Steer system operation

Engage the system

Note – Before you can engage the EZ-Steer system, you must:

- Set up and calibrate the system.
 - Open a field in the Guidance screen.
 - Map an AB line.
 - Position the vehicle within the configured engage limits.
1. To engage the system, point the nose of the vehicle toward the guidance line and drive at operational speed.
 2. To engage, you can:
 - Tap  at the *Guidance* screen.
 - Use an external foot or rocker switch (see [Foot or rocker switch setup, 85](#)).

Disengage automatically



The EZ-Steer system automatically disengages when:

- The vehicle is outside the configured engage limits.
- You pause the system.
- GNSS positions are lost.
- You tap  on the *Guidance* screen.

Disengage manually



You can manually disengage the EZ-Steer system by turning the steering wheel (this overrides the electric motor). Check this setting before you start using the system by engaging on a line and then turning the wheel until the system disengages. To adjust the amount of force required to disengage the system, change the Override Sensitivity in the *Engage Options* screen.

Engage on-screen control

Button/Indicator	Tap to...	Indicates
 (Yellow)	Engage the auto steering system	System is ready to engage
 (Green)	Disengage the auto steering system	System is engaged
 (Red)	Indicator only	System cannot engage



Changing from forward to reverse

The CFX-750 display displays a button indicating the direction you are traveling:

- Forward: 
- Reverse: 

As you are applying material in the field when using EZ-Steer, you may want to manually move the tractor in reverse. When the tractor moves in reverse, the button switches to .

If the display does not reflect that you are moving in the reverse or forward direction, to indicate to the display the correct direction, tap:

-  if you are moving forward
-  if you are moving in reverse

Adjust aggressiveness

At the *Guidance* screen, tap  to open the control for adjusting aggressiveness.



Curve Auto steering Accuracy in Headlands

It is possible to engage the EZ-Steer system on headlands with sharp corners at the edge of the field. However, the EZ-Steer system may be unable to drive around these sharp bends. To compensate, use either of these:

- Manually steer the vehicle around the corner. After you have rounded the corner, re-engage the EZ-Steer system.
- At the *Engage Options* screen, increase the Disengage Offline distance (see [EZ-Steer system setup, 56](#)).

Vehicle-specific performance suggestions

Before you use the EZ-Steer system, consider the following performance suggestions.

Vehicle Type	Performance Suggestion
2WD tractor	<p>With tractors that have SuperSteer (for example, New Holland TG) and have a SuperSteer front axle, for best performance:</p> <p>Reduce the Online Aggressiveness value.</p> <p>Line up close to the swath and make certain that the front wheels are straight before engaging the EZ-Steer system.</p> <p>To get smoother performance when the vehicle is pulling an implement over tilled ground, enable the Diff-Lock. This prevents the machine from pulling sharply to the left or right. If you are calibrating on a hard surface, turn off Diff-Lock.</p>
4WD tractor	<p>The EZ-Steer system can be installed on Case IH STX tractors with Accusteer. For optimal performance, disable Accusteer using the switch in the cab (if possible).</p>

Vehicle Type	Performance Suggestion
Sprayer	<p>It is common for these vehicles to have slow steering. To compensate for this, use high aggressiveness.</p> <p>If you experience large, slow oscillations, increase the aggressiveness.</p> <p>When you configure the system on a sprayer, the sprayer steering delay setting is available on the <i>Vehicle Setup</i> screen.</p> <p>Some sprayers have steering that is slow to react after you turn the steering wheel. The system uses the steering delay setting to compensate for this slowness and ensure that steering corrections occur at the correct point.</p>
Swather	<p>When you configure the system on a swather, the Swather steering delay setting is available on the <i>Vehicle Setup</i> screen.</p> <p>Some swathers have steering that is slow to react after the steering wheel is turned. The system uses the steering delay setting to compensate for this slowness and ensure that steering corrections occur at the correct point.</p> <p>To improve the performance of your swather, adjust the Swather steering delay setting by a small amount (0.1 seconds) at a time. Test the result between each adjustment.</p>

After using the EZ-Steer system

Any time that you are not using the EZ-Steer system, pivot the EZ-Steer motor away from the steering wheel.

Before you leave the vehicle, turn off the EZ-Steer system power switch or remove the power plug.

EZ-Pilot system operation



CAUTION – Do not operate the EZ-Pilot system while driving in reverse gear.

Engage the system

Note – Before you can engage the EZ-Pilot system, you must:

- Set up and calibrate the system.
- Open a field in the Guidance screen.
- Map an AB line.
- Position the vehicle within the configured engage limits.

1. To engage the system, point the nose of the vehicle toward the guidance line and drive at operational speed.
2. To engage, you can:
 - Tap  at the *Guidance* screen.
 - Press the engage button on the optional remote control.
 - Use an external foot or rocker switch (see [Foot or rocker switch setup, 85](#)).



CAUTION – If you use the vehicle on a public roadway, you must put the red EZ-Pilot system override switch in the off position.

Disengage automatically

The EZ-Pilot system automatically disengages when:

- The vehicle is outside the configured engage limits.
- You pause the system.
- GNSS positions are lost.
- You tap the  button on the *Guidance* screen.
- You press the **Engage** button on the optional EZ-Remote joystick.

Disengage manually



You can manually disengage the EZ-Pilot system by turning the steering wheel. This overrides the electric motor.

Check this setting before you start using the system by engaging on a line and then turning the wheel until the system disengages.

To adjust the amount of force required to disengage the system, change the Override Sensitivity in the *Engage Options* screen. See [EZ-Pilot system setup, 62](#).



Engage on-screen control

Button/Indicator	Tap to...	Indicates...
 (Yellow)	Engage the auto steering system	System is ready to engage

Button/Indicator	Tap to...	Indicates...
 (Green)	Disengage the auto steering system	System is engaged
 (Red)	Indicator only	System cannot engage



Changing from forward to reverse

The CFX-750 display displays a button indicating the direction you are traveling:

- Forward: 
- Reverse: 

As you are applying material in the field when using EZ-Pilot, you may want to manually move the tractor in reverse. When the tractor moves in reverse, the button switches to .

If the display does not reflect that you are moving in the reverse or forward direction, to indicate to the display the correct direction, tap:

-  if you are moving forward
-  if you are moving in reverse

After using the EZ-Pilot system

 **CAUTION** – Before you leave the vehicle, turn off the power to the display which will turn off the EZ-Pilot system power.

Autopilot system operation

You must calibrate and set up the Autopilot automated steering system before operation.

Engage the system

Note – Before you can engage the Autopilot system, you must:

- Set up and calibrate the system.
- Open a field in the *Guidance* screen.
- Map an AB line.
- Position the vehicle within the configured engage limits.

To engage the system:

1. Point the nose of the vehicle toward the guidance line and drive at operational speed.
2. Engage the system by either:
 - Tapping  at the *Guidance* screen
 - Pressing the optional remote engage foot pedal

Disengage automatically

The Autopilot automated steering system automatically disengages when:

- The vehicle is manually steered, causing a manual override.
- The vehicle is outside the configured engage limits.
- You pause the system.
- GNSS positions are lost.
- You tap  on the *Guidance* screen.



Disengage manually

You can manually disengage the Autopilot system by turning the steering wheel.

Check the manual override setting before you start using the system by engaging on a line and then turning the wheel until the system disengages.

To adjust the amount of force required to disengage the system, change the *Manual Override* sensitivity in the *Autopilot Setup* screen.

Engage on-screen control

Button/Indicator	Tap to...	Indicates...
 (Yellow)	Engage the auto steering system	System is ready to engage
 (Green)	Disengage the auto steering system	System is engaged
 (Red)	Indicator only	System cannot engage

Adjust aggressiveness

At the *Guidance* screen, tap  to open the control for adjusting aggressiveness.



After using the Autopilot steering system

Before you leave the vehicle turn off the system power switch or remove the power plug.

EZ-Remote joystick use

The standard buttons on the EZ-Remote joystick are:



Item	Button	Explanation
①	Customized	Can be customized to control a function. See EZ-Remote Joystick custom settings, 86 .
②	Customized	Can be customized to control a function. See EZ-Remote Joystick custom settings, 86 .
③	Engage	Engage auto steering.
④	Customized	Can be customized to control a function. See EZ-Remote Joystick custom settings, 86 .

5	Customized	Can be customized to control a function. See EZ-Remote Joystick custom settings, 86 .
6	Left	Nudge the guidance line to the left at the <i>Guidance</i> screen.
7	Right	Nudge the guidance line to the right at the <i>Guidance</i> screen.
8	Up and down	<i>Not supported.</i>
9	Trigger	On the back. <i>Not supported.</i>

Lightbar patterns



Use the integrated lightbar to obtain accurate guidance when:

- You have set an implement offset or implement draft
- Fine-tuning guidance on straight swaths

When lighted, the LEDs show the position of your vehicle as it relates to your intended guidance line. As your vehicle position changes in relation to the guidance line, the LEDs are lighted to the left or right.

When your vehicle is on the guidance line, the three central green LEDs are lighted.

As your vehicle moves off the guidance line, the lighted LEDs change to the left or right, and change to red.

LED position and color	The vehicle is...
LEDs are green and in center. 	Directly on the guidance line.
One green LED in center and two red LEDs to the right 	Off the guidance line. For this pattern, if the Main Lightbar LED Mode is set to: <ul style="list-style-type: none"> • Chase: Vehicle is to the left of the guidance line • Pull: Vehicle is to the right of the guidance line

One green LED in center and two red LEDs to the left













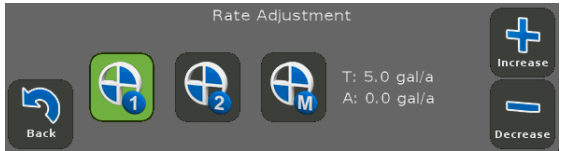





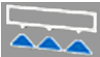

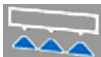







Off the guidance line. For this pattern, if the Main Lightbar LED Mode is set to:

- Chase: Vehicle is to the right of the guidance line
- Pull: Vehicle is to the right of the guidance line

Field-IQ operation

After you have enabled, configured and calibrated your Field-IQ crop input control system, information and buttons will display on the *Guidance* screen depending on your operation.

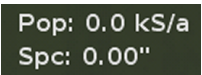
Button/Information	Name	Explanation
	Material	Use this button to switch between materials.
	Virtual Rate button showing current target rate	Shows the current target rate. Opens the Rate Adjustment panel with rate switch position buttons. Tap one of the rate switch buttons to change the rate.
		
	Virtual Section Switch	Shows the current section mode for the controller.
		Automatic: 
		Manual: 
	Virtual Master Switch	Shows the Master Switch status.
		On: 
		Off: 

Button/Information	Name	Explanation
	Section control	<p>Automatic: </p> <p>Manual: </p>
	Quick Access button	<p>Opens additional controls. See Quick access button for Field-IQ, 232.</p>
	Coverage logging status	<p>On:  (Green with checkmark)</p> <p>Off:  (Gray with red X)</p> <p>Inactive:  (Gray)</p>
	Target rate	<p>The target application rate for the current rate switch position. This is the amount of product that you want to apply.</p>
	Actual rate	<p>The actual application rate. This is the amount of product that is currently being applied.</p>
	Row monitoring bar	
	Sensor Information	<p>Shows current information for the selected sensors.</p>
	Cycle button	<p>Available if you have more than 12 rows to view.</p>

Quick access button for Field-IQ

When you are running Field-IQ or a variable rate controller, the quick access button displays on the *Guidance* screen.



You can use the Quick Access button to access:

- [Boom setup](#)
- [Refill](#)
- [Section switching setup](#)
- [Boundary switching overlap](#)
- [On/off valve latency](#)
- [Intentional overlap](#)
- [Target rate](#)
- [Valve aggressiveness](#)

Note – *The items you can adjust will depend on the applications that you are currently running.*

Boom setup

Setting	Description
Implement width	The width of the current implement. The display uses this value to automatically calculate the swath spacing. Enter a width between 1' 00" - 328' 01" (0.30 - 99.99 m).
Boundaries	See Boundaries in Guidance settings, 146 .
Number of sections	The number of sections you want to control on the implement. Enter a number between 1 - 10.

Refill

Setting	Description
Current volume	The current volume of the tank or bin.

Setting	Description
Refill method	<ul style="list-style-type: none"> • Refill: To fill the tank or bin to the top • Partial Refill: To add a specified amount to the tank or bin when you tap Partial Refill Now from the <i>Refill</i> screen.
Refill Now / Partial Refill Now	Use this option to refill the tank or bin.

Section switching setup

Setting	Description
Coverage switching overlap	<p>The amount of boom switching overlap allowed before the system switches that section. Enter a percentage between 1-99%.</p> <p>For:</p> <ul style="list-style-type: none"> • Less skip: Set a high percentage when total coverage is essential. The system will turn off sections when they cover a larger percentage of any fully covered areas. This may cause some double-coverage. Sections will turn on as soon as they move from a covered to an uncovered area. • Less overlap: Set a low percentage when you need to save product. The system will turn off sections as soon as you reach any covered area. This may leave some skips. Sections will turn on when the entire section has moved from a covered to an uncovered area.
Refill method	<ul style="list-style-type: none"> • Refill: To fill the tank or bin to the top • Partial Refill: To add a specified amount to the tank or bin when you tap Partial Refill Now from the <i>Refill</i> screen.
Refill Now / Partial Refill Now	Use this option to refill the tank or bin.

Boundary switching overlap

Use this option to control the amount of overlap on a boundary before the system switches off the boom section. Enter a percentage between 1-99%.

Note – *This setting operates only when the boom is overlapping a headland, pivot boundary, or exclusion zone.*

For:

- Less skip: Set a high percentage when it is acceptable to apply outside the boundary.
- Less overlap: Set a low percentage when you do not want to apply outside the boundary. A very low setting may cause some skip at the boundary.

On/off valve latency

This option allows for hardware delays by adjusting the amount of time needed before turning the valves on or off. To use this option:

Measure the amount of time it takes (in seconds) for the system to reach the correct rate after you have switched it on or off.

Enter a time between 0.0 - 10.0 seconds.

Intentional overlap

You can use this option to make sure that when applying, there are no gaps in coverage if you move into an uncovered area or out of a covered area.

Setting	Description
On overlap distance	Exiting a covered area and switching the implement on
Off overlap distance	Entering a covered area and switching the implement off

Target rate

Use this option to set the amount of product you want to apply (the target application rate). Enter a number between 1333 - 41333.

Valve aggressiveness

If you use an auto-steer system, such as an EZ-Steer® or Autopilot™ system, you can use this option to adjust how the system responds to steering changes.

- A higher setting brings the vehicle back on line quickly, but may cause tight oscillations.
- A lower setting gives a more moderate response to bringing the vehicle back on line, but can avoid overshoot.

Enter a setting between 50 - 150%.

Field-IQ master switch box

Note – All systems must have a Field-IQ master switch box.



Item	Name	Explanation
1	Increment/decrement switch	Increases the applied amount by a set amount (the amount set in the <i>Setup</i> screen, Rate tab).
2	Rate switch	Preset Rate 1, preset Rate 2, or Manual rate.
3	LED indicator	<ul style="list-style-type: none"> Red: Unit is powered but not communicating with the CFX-750 display. Green: Unit is powered and communicating with the CFX-750 display. Yellow: Unit is initializing communications with the CFX-750 display.
4	Automatic/Manual section switch	<ul style="list-style-type: none"> Automatic mode: The CFX-750 display automatically opens and closes sections when entering areas of overlap, non-apply zones, or crossing boundaries. Manual mode: The sections are controlled manually, bypassing the CFX-750 display. <p>Note – You can switch from Automatic to Manual mode while traveling.</p>

Item	Name	Explanation
5	Master switch	<ul style="list-style-type: none"> • A: Jump start (top position) The sections and rate are ready to be commanded by the CFX-750 display, and the system is overridden to use a preset control speed (the speed is set in the <i>Setup</i> screen, <i>Override</i> tab). Use the jump start function if you lose a GNSS signal or you want to start applying before your implement is up to speed. • B: On (middle position) The sections and rate are ready to be commanded by the CFX-750 display. • C: Off (lower position) Sections are closed and rate is set to zero.

Field-IQ 12-section switch box



The 12 section switch box is:

- Required for section control
- Optional for rate control only

Only one section switch box can be used on each system. Each section switch is automatically assigned to the corresponding module. The modules are read from left to right. For example, switch 1 assigns to the module furthest on the left when standing behind the implement.

The section switches have different functions, depending upon the status of the master Automatic/Manual section switch on the master switch box.

Automatic/Manual section switch

When the Automatic/Manual section switch is in the **Automatic** position:

- In the on/up position: The section(s) assigned to it are commanded automatically by the CFX-750 display.
- In the off/down position: The section(s) assigned to it are commanded to be off.

When the Automatic/Manual section switch is in the **Manual** position:

- In the on/up position: The section(s) assigned to it are commanded to be on. This overrides the CFX-750 display and coverage logging is ignored.
- In the off/down position: The section(s) assigned to it are commanded to be off. This overrides the CFX-750 display and coverage logging is ignored.

LED status lights

The LED status indicators are:

- Green: The unit is powered and is communicating with the display.
- Yellow: The unit is initializing communications with the display.
- Red: The unit is powered but not communicating with the display.





Operate implement controllers

The controls and indicators that display on the *Guidance* screen depend on the type of implement controller you are using:

- Amazone (see [Amazone controller operation, 238](#))
- Hardi 5500/6500 (see [HARDI 5500/6500 controller operation, 239](#))
- LH5000 (see [LH5000 controller operation, 240](#))
- Raven (see [Raven controller operation, 241](#))
- Rawson (see [Rawson controller operation, 242](#))

Amazone controller operation



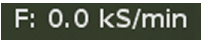
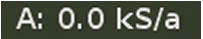





When you connect the Amazone controller to the display, the following displays on the *Guidance* screen.



Button/Information	Name	Explanation
	Quick Access button	Opens additional controls. See Quick access button for Field-IQ, 232 .
	Coverage logging status	On:  (Green with checkmark) Off:  (Gray with red X) Inactive:  (Gray)
	Target rate	The target application rate for the current rate switch position. This is the amount of product that you want to apply. If a prescription is loaded, P displays to indicate that the prescription rate is being used rather than the target rate.
	Actual rate	The actual application rate. This is the amount of product that is currently being applied.

Button/Information	Name	Explanation
	Boom section status indicators	Shows the current state of each boom section: <ul style="list-style-type: none"> • Green: Enabled and spraying • Gray: Enabled but not currently spraying • Red: The section is off (the switch is off)
	Application indicator	The wheel on the display spins when the Amazone master switch is on and the lightbar receives flow messages from the controller.

HARDI 5500/6500 controller operation

When you connect the HARDI 5500 controller to the CFX-750 display, the following displays on the *Guidance* screen.

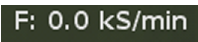

Button/Information	Name	Explanation
	Quick Access button	Opens additional controls. See Quick access button for Field-IQ, 232 .
	Section control	Shows the current section mode for the controller.
		Automatic: 
		Manual: 
	Coverage logging status	On:  (Green with checkmark) Off:  (Gray with red X) Inactive:  (Gray)

Button/Information	Name	Explanation
	Target rate	<p>The target application rate for the current rate switch position.</p> <p>This is the amount of product that you want to apply.</p> <p>If a prescription is loaded, P displays to indicate that the prescription rate is being used rather than the target rate.</p>
	Actual rate	As the HARDI controller does not report the actual applied rate to the display, this item always displays as N/A.
	Boom section status indicators	<p>Shows the current state of each boom section:</p> <ul style="list-style-type: none"> • Green: Enabled and spraying • Gray: Enabled but not currently spraying • Red: The section is off (the switch is off)
	Application indicator	The wheel on the display spins when the HARDI master switch is on and the booms are on.
	Fence nozzle indicator	<p>This indicator displays only when a fence nozzle is enabled. Fence nozzle status is represented with the same colors as the boom sections (see below).</p> <p>The CFX-750 display cannot automatically turn fence nozzles on or off. It only displays the current status.</p>

LH5000 controller operation

When the LH 5000 variable rate controller is connected to the display, the following displays on the *Guidance* screen.

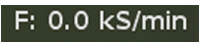
Button/Information	Name	Explanation
	Quick Access button	<p>Opens additional controls.</p> <p>See Quick access button for Field-IQ, 232.</p>

Button/Information	Name	Explanation
	Target rate	<p>The target application rate for the current rate switch position. This is the amount of product that you want to apply.</p> <p>If a prescription is loaded, P displays to indicate that the prescription rate is being used rather than the target rate.</p>
	Actual rate	<p>The actual application rate. This is the amount of product that is currently being applied.</p>
	Boom section status indicators	<p>Shows the current state of each boom section:</p> <ul style="list-style-type: none"> • Green: Enabled and spraying • Gray: Enabled but not currently spraying • Red: The section is off (the switch is off)
	Application indicator	<p>The wheel on the display spins when the Amazone master switch is on and the lightbar receives flow messages from the controller.</p>

Raven controller operation

When you connect the Raven controller to the CFX-750 display, the following displays on the *Guidance* screen.

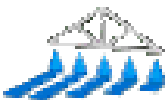
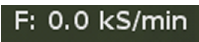
Button/Information	Name	Explanation
	Quick Access button	<p>Opens additional controls.</p> <p>See Quick access button for Field-IQ, 232.</p>
	Target rate	<p>The target application rate for the current rate switch position. This is the amount of product that you want to apply.</p> <p>If a prescription is loaded, P displays to indicate that the prescription rate is being used rather than the target rate.</p>

A: 0.0 kS/a	Actual rate	The actual application rate. This is the amount of product that is currently being applied.
	Boom section status indicators	Shows the current state of each boom section: <ul style="list-style-type: none"> • Green: Enabled and spraying • Gray: Enabled but not currently spraying • Red: The section is off (the switch is off)
	Application indicator	The wheel on the display spins when the Amazone master switch is on and the lightbar receives flow messages from the controller.

Target Rate

To manually enter a rate to send to the controller:

1. At the *Settings* screen, tap .
2. At the *Implement* screen, tap **Advanced**.
3. Tap **Target Rate** and then adjust the rate that is sent to the controller.

Automatic Boom Switching

The CFX-750 display does not perform automatic boom switching for the Raven controller.

Note – *To ensure that areas outside the headland, in exclusion zones, or previously sprayed areas are not sprayed, you will need to manually turn off the Raven controller master switch.*

Rawson controller operation

When you connect the Rawson controller to the display, the following displays on the *Guidance* screen.

Button/Information	Name	Explanation
	Quick Access button	Opens additional controls. See Quick access button for Field-IQ, 232 .

F: 0.0 kS/min	Target rate	<p>The target application rate for the current rate switch position.</p> <p>This is the amount of product that you want to apply.</p> <p>If a prescription is loaded, P displays to indicate that the prescription rate is being used rather than the target rate.</p>
A: 0.0 kS/a	Actual rate	<p>The actual application rate.</p> <p>This is the amount of product that is currently being applied.</p>
	Boom section status indicators	<p>Shows the current state of each boom section:</p> <ul style="list-style-type: none"> • Green: Enabled and spraying • Gray: Enabled but not currently spraying • Red: The section is off (the switch is off)
	Application indicator	<p>The wheel on the display spins when the Amazone master switch is on and the lightbar receives flow messages from the controller.</p>

Boom Height Control operation

You can use the Boom Height Control system to:

1. Monitor boom height (before enabling, or if you selected *Monitor Only* on the *Boom Control Options* screen).

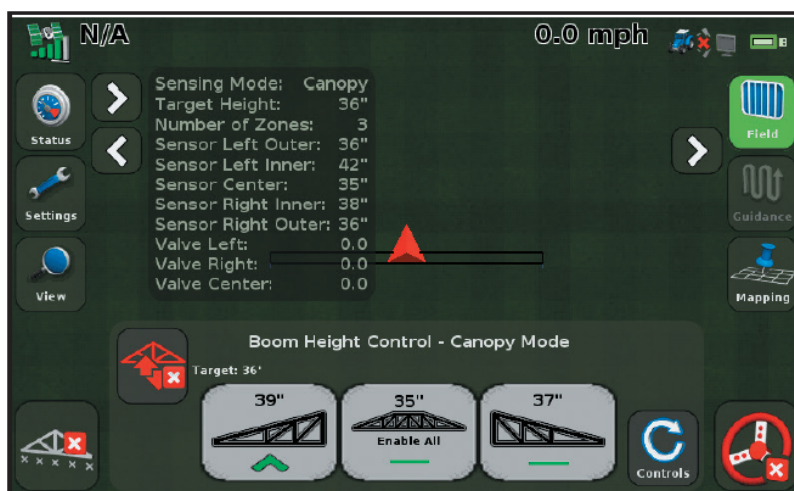

2. Enable the zone or zones you want to control.







3. Engage the enabled zone or zones.
4. Use the *Controls* to adjust *Target Height* and *Aggressiveness*.
5. Before transporting the vehicle or folding the booms:
 - a. Disable boom height control on all zones.
 - b. Tap the E-Stop button.
 - c. Close the field.

Monitor boom height

When Boom Height Control is disabled on zones (or if you set *Monitor Only* on the *Boom Control Options* screen), the section buttons are gray.

A symbol on the buttons (for example, a red arrow) indicates:

- The direction that the section is off target
- How far the section is off target

Indicator	Explanation
	The boom is significantly below the target height. Raise the boom to reach the target.
	The boom is somewhat below the target height. Raise the boom to reach the target.
	The boom is slightly below the target height. Raise the boom to reach the target.
	The boom is at the target height.
	The boom is slightly above the target height. Lower the boom to reach the target.
	The boom is somewhat above the target height. Lower the boom to reach the target.
	The boom is substantially above the target height. Lower the boom to reach the target.

Enable a control zone

Boom Height Control for a one zone or all zones can be:

- Disabled: Boom Height Control is not available and the button color is gray.
- Enabled: Automatic boom height control is available and the button is yellow.

To enable:



- A single control zone, tap the button for that section.
- All zones, tap **Enable All**.

Note – You can only enable all zones when the system is not engaged and all zones are disabled (button is shown as gray).



Note – If you are currently engaged on other zones, any additional zones will engage automatically.

After enabling:

- A single control zone, the system is ready to engage when:
 - The button for that zone turns yellow.
 - The **Engage** button turns yellow .
- All zones the system is ready to engage when:
 - The button for all zones turns yellow.
 - The **Engage** button turns yellow .
 - The center button toggles to **Disable All**.

Tap **Disable All** if you want to disable all zones.



If any zones/sections are not enabled, the center button shows the center section.



Boom Height Control is not active (not operational) until you engage the enabled zones.

Engage enabled zones

1. To engage all enabled zones, tap **Engage** (yellow) .

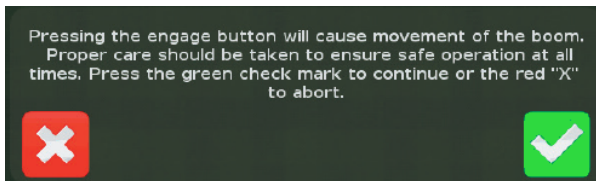
The first time you engage Boom Height Control after the display is turned on, a safety message displays:



2. At the safety message:
 - Tap  to engage the enabled zones.
 - Tap  if you do not want to engage the enabled zones.

Note – If all zones are enabled but not engaged for 30 seconds, Boom Height Control disables the zones as a safety measure. You must re-enable zones again before engaging the system.

While Boom Height Control is engaged (operational):

- The **Engage** button is green.



- The button for each engaged section is green.



The number at the top of each button indicates:

- For a section with only one sensor: The distance from the sensor to the ground or canopy
- For a section with multiple sensors: The average distance from the sensors to the ground or canopy

A symbol on button (for example, a red arrow) shows:

- The direction that the section is moving to get closer to the target height
- How far the section is off target (indicated by color)

Note – The **Engage** button is green when any zone is engaged. The **Engage** button is yellow when **all** sections are disengaged, but at least one is enabled.

Adjust target height and aggressiveness

You can adjust both the target height and the aggressiveness.

1. Tap **Controls**.

The Boom Height Control section of the screen changes to show the Target Height and Aggressiveness controls.



2. To adjust the target height, tap the increase or decrease arrows below the *Target Height* heading.
3. To adjust the aggressiveness of the system, tap the increase or decrease arrows below the *Aggressiveness* heading.
4. To set the target height to the current boom height, tap **Use Current**.
5. To return to the sections view, tap **Boom**.

Disengage engaged zones

Single zone

1. To disengage a single zone, tap the button for that section. The button for the section changes from green to yellow. Boom Height Control is no longer actively controlling the section, but is still enabled.

2. To re-engage, tap the button while it is yellow:

- The system re-engages Boom Height Control for that section if any other sections are still engaged.
- Disables that section if no other section is engaged.

All zones

To disengage all zones, tap  if it is green. The buttons for all engaged sections change from green to yellow (enabled but not engaged).

Disable Boom Height Control

Before transporting the vehicle or folding the booms, disable Boom Height Control.

Single zone disabled

To disable single zones, you can use either of these methods:

- Tap each green section button individually (which changes each button to yellow).
- Tap  if it is green.

All zones disabled

To disable all zones, you can use either of these methods:

- Tap **Disable All**.

Note – This button is available only when all zones are disengaged but enabled.



- Tap the enabled (yellow) sections individually.

If any section is still engaged, this will re-engage the section you tap. You must disengage all sections first.

Make sure that all zones are disabled:

- If any button is yellow or green, repeat steps 1-3 until all sections are disabled.
- The buttons for each zone should be gray and the Engage button should be red.



Tap the **E-Stop** button. The **E-Stop** button is a red hardware button that prevents Boom Height Control from communicating with the equipment. Refer to the *Boom Height Control Installation Instructions* for additional information.

To close the field, tap .

When asked if you are finished with the current field, tap **Yes**.

Follow the equipment manufacturer's recommendations to fold the booms or transport the vehicle.

Note – *If the center boom section is raised for 3 seconds using input from a joystick, Boom Height Control is disabled as a safety feature for folding the boom.*

Yield Monitoring operation

When you are running Yield Monitoring,  displays on the *Guidance* screen. Tap  to display details about each load.

Name	Explanation
Load Details	Choose the load you want to view details on.
Scale Ticket Weight	Weight registered on scale
Test Weight	Current crop test weight
Moisture	Yield moisture sensor calibration. Also see Yield flow and moisture sensor calibration, 160.
Header Height	The height percentage at which logging turns on and off. Also see Header Height Calibration, 158.
Map Legend Setup	Enables you to determine the scale on the Yield and Moisture layers that are displayed on the display.
Coverage Theme	The theme you want to use: Yield, Moisture or Overlap. To change coverage logging settings, see Coverage Logging.

Also see [Yield Monitoring calibration, 158.](#)

View map legend

At the *Guidance* screen, tap  to view field or load statistics or the map legend.



Increase or decrease swath header swath width

Tap the arrow buttons to increase or decrease header swath width.



Start and stop loads

Tap **New Load** to start and stop loads for calibrations and load tracking. The CFX-750 display can hold up to 250 loads.



Turn logging on or off manually

Tap the logging button to manually turn logging on or off.

Note – The header height function will turn it on and off in accordance with the header position.



The legend correlates the yield to the color shown for the current coverage theme.

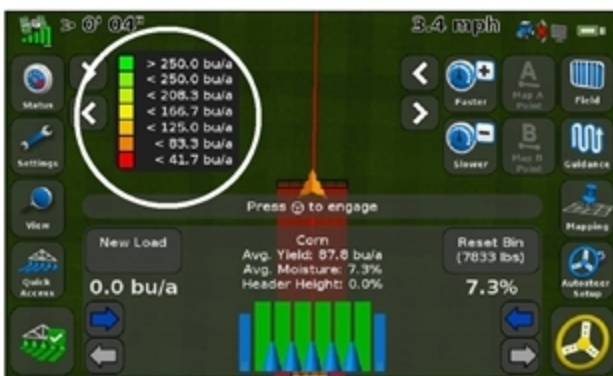

Track amount in grain bin



You can use the grain bin level status item to track the amount of grain in the grain bin. Set up the size of the grain bin in the Yield Monitoring Setup wizard. Tap the button to reset the counter.



Coverage logging

Coverage logging draws a solid block of color on the screen behind the vehicle to show the area that you have applied. When you pass over an area for the second time, the color of the covered area changes. This is useful for viewing overlaps.

Note – Field coverage is limited to 1000 acres for each event.

1. To begin coverage logging, tap  while you are driving.
2. To finish coverage logging tap .

Note – There may be a delay between the time you start or stop coverage logging on screen and the time the implement actually starts or stops coverage. To compensate for this you can add a time delay to the drawing of coverage logging. See [Yield Monitoring operation, 250](#).

Change coverage logging theme

1. Tap  to access the *Yield Monitor Quick Access* screen.
2. Tap **Coverage Theme**.
3. Tap which theme you want:
 - **Yield**
 - **Moisture**
 - **Overlap**

Apply constant moisture value

To turn off the automated moisture sensor readings and apply a constant moisture value to the crop being harvested, tap **Manual**. Enter the percentage for manual moisture.



Enter test weight of crop

You can enter the test weight of the crop being harvested to maintain yield monitoring accuracy.



Current Crop Test Weight

Enter test weight

56.0 lbs/bu

Max: 776.9 lbs/bu
Min: 0.0 lbs/bu

7	8	9
4	5	6
1	2	3
0	.	C

Office Sync operation

Data transfer to Connected Farm

With Office Sync enabled, field and task data are automatically transferred wirelessly to Connected Farm.

- Automatic transfer: Jobs are automatically sent after closure of the field . However, if you experience poor wireless service or coverage, the display will put the job in a queue and automatically send it once wireless service is regained.
- Manual transfer: If you want to upload a field or historical task without re-opening and closing it, you can send it manually from the display. To manually send a field:
 - a. Navigate to Setup / Data / Manage Data / Office Sync / Send Data / Send Fields to Office Sync.





- b. From the *Send Fields to Office Sync* screen select the Client, Farm, Field and Event to send and tap . The display will send the job immediately if connected to a wireless network, or queue the data to be sent later if there is poor service or lack of coverage.

Receiving data from Connected Farm or FarmWorks

The display automatically checks the server for new jobs when connected, and holds these jobs in a queue to be imported into the display. To access received data and import it:

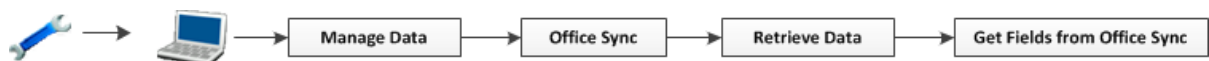
1. Navigate to Setup / Data / Manage Data / Office Sync / Retrieve Data / Get Fields From Office Sync.



2. If the *Get Fields From Office Sync* screen shows there is data that has been received, select the data to retrieve and tap  to import. After the data is imported, the fields and jobs can be loaded and used for field operations.

Appendix

In this chapter:

Rate Control Setup	258
Row Crop Seed Setup	259
Row Monitoring Setup	260
Section Control Setup	261
Sensor Setup	262
Guidance screen buttons	263
Feature mapping buttons	268
Setting screen buttons	269
Automatic steering controls	271

This section contains content you can use for quick reference.

Rate Control Setup

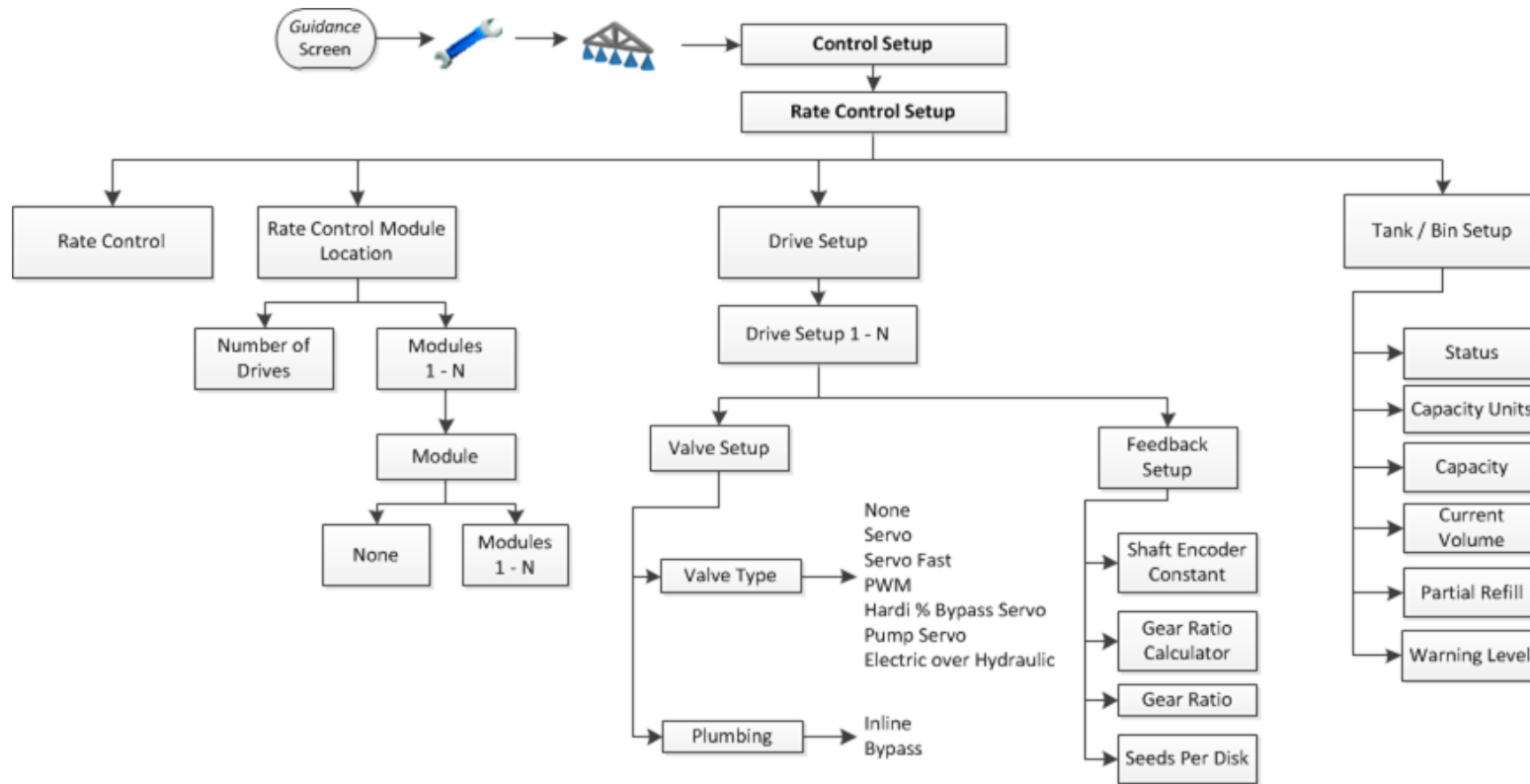

Row Crop Seed Setup

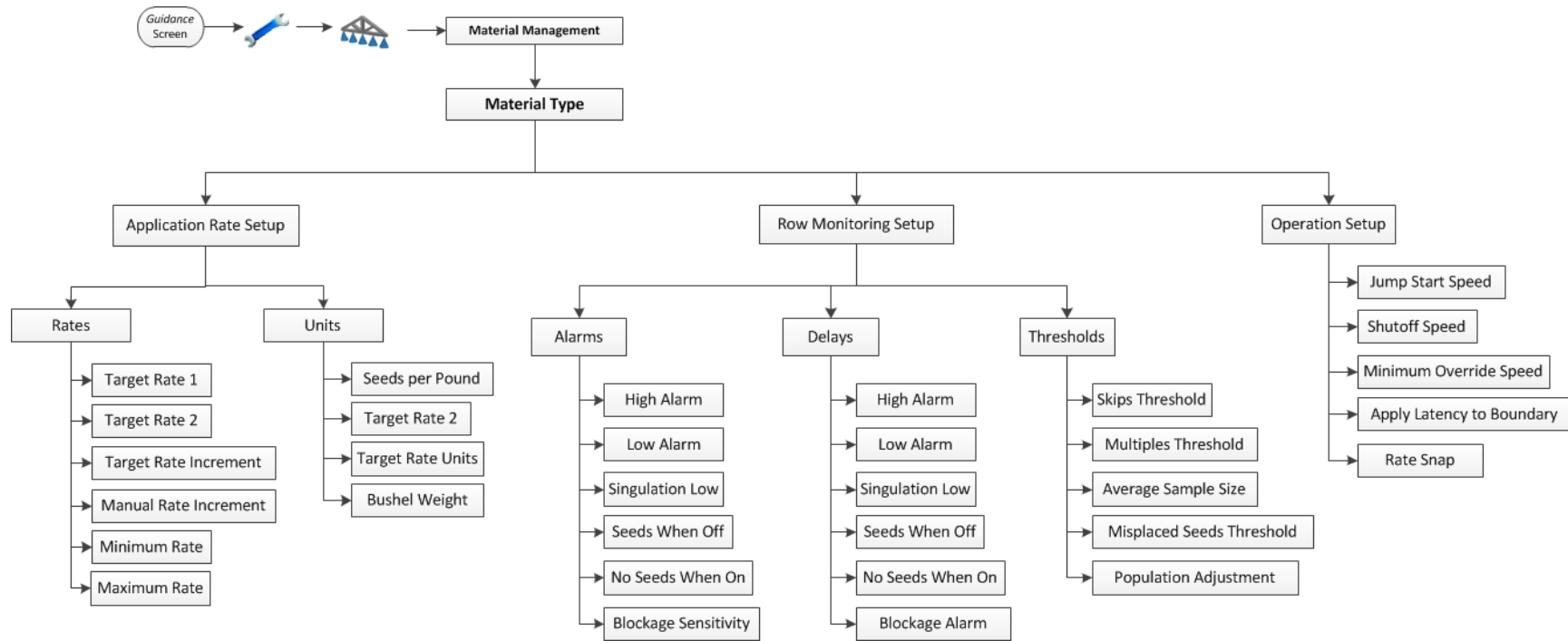

Row Monitoring Setup

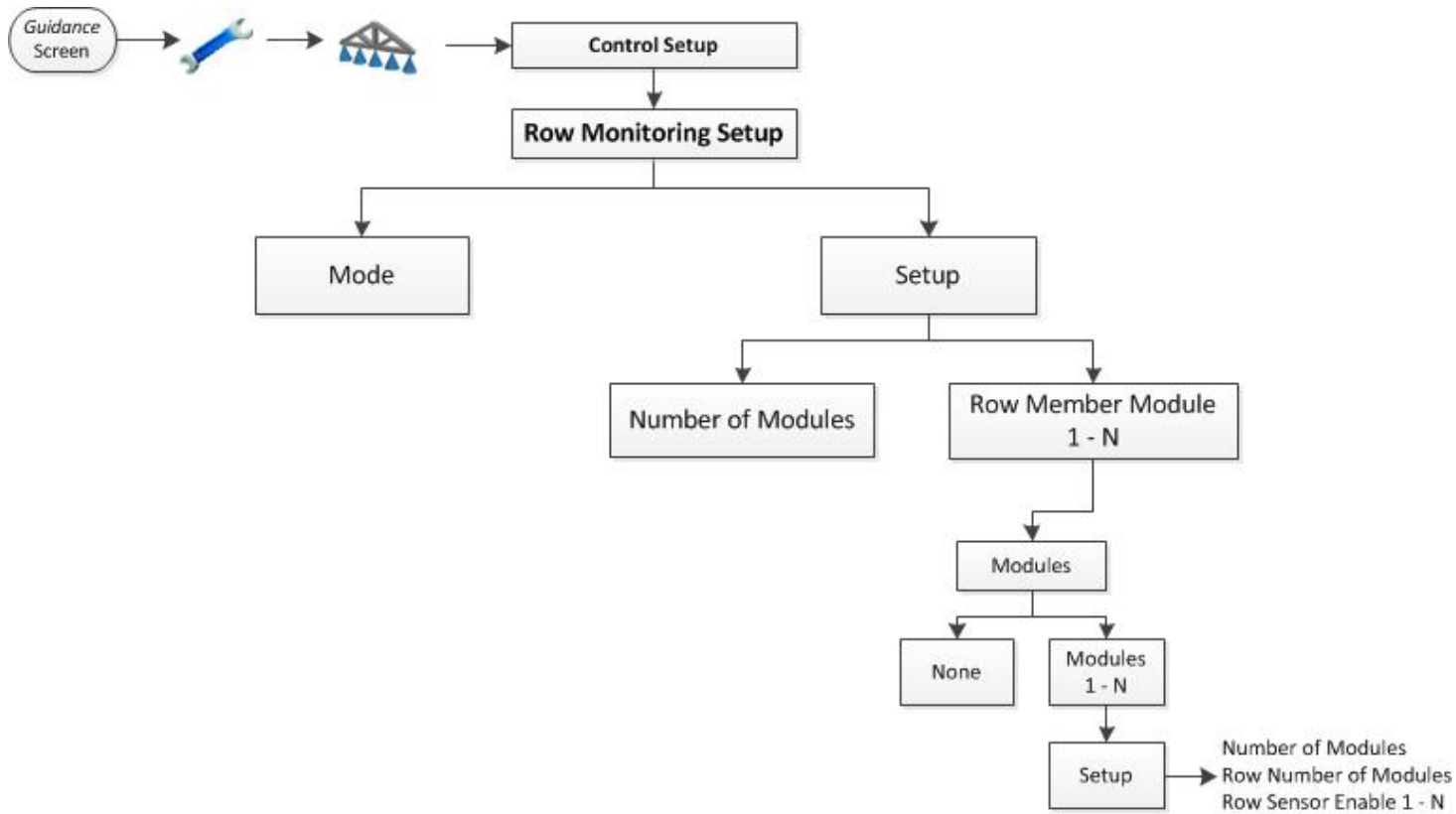



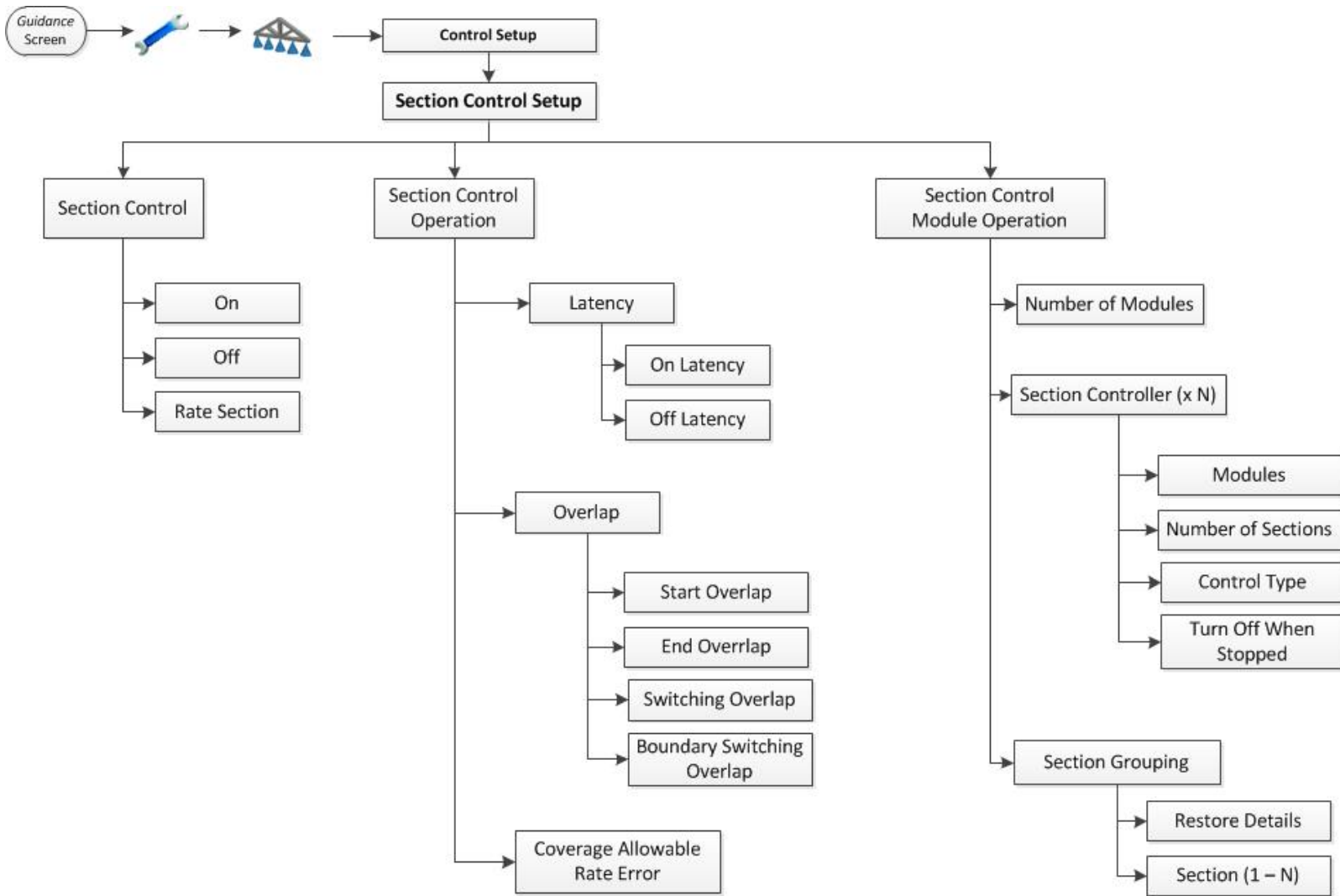



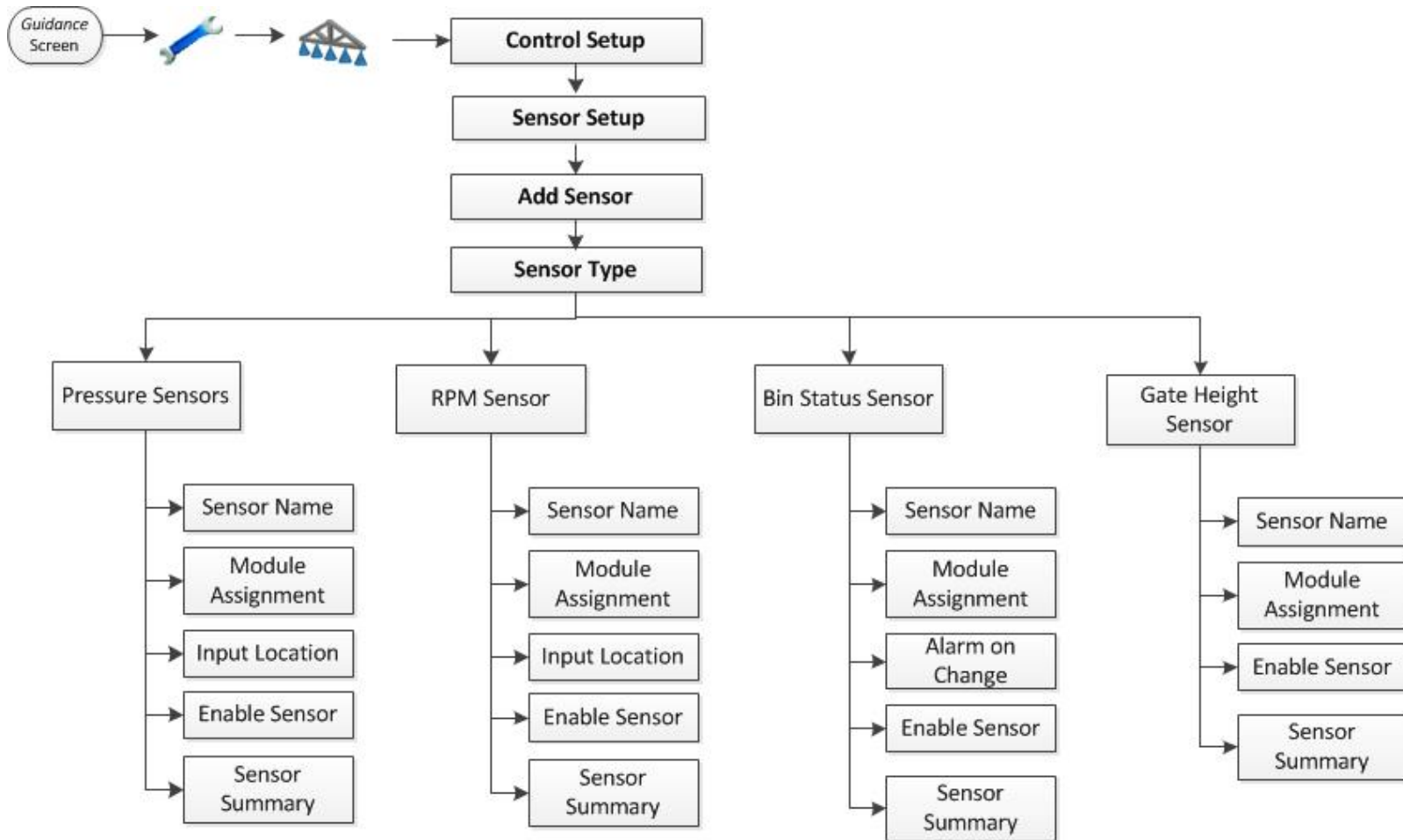





Section Control Setup













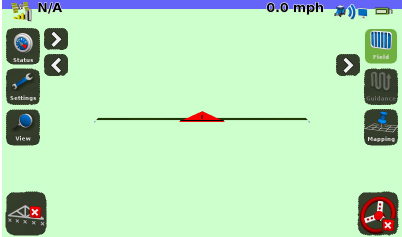

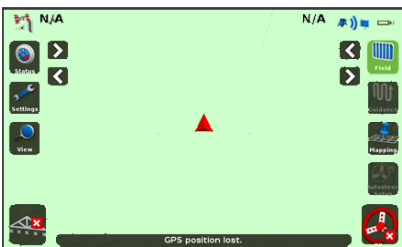
Sensor Setup

















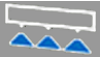

Guidance screen buttons

Button	Function	Tap to.../Indicates...																
	Status	<p>See the status of field information and move the status information left or right to expose the Camera features (Camera A and Camera B).</p> <p>To rotate through the status information you keep tapping .</p> <p>Tap  to see the next view.</p> <p>Tap  to see the previous view.</p> <div data-bbox="1150 578 1747 878"><p>The screenshot shows a dark green interface with a 'Status' button (gauge icon) and a 'Settings' button (wrench icon) on the left. In the center are right and left arrow buttons. On the right, the following field information is displayed:</p><table border="1"><tr><td>Field Name:</td><td>083110_0001</td></tr><tr><td>Field Area:</td><td>0.00 a</td></tr><tr><td>Productive Area:</td><td>0.00 a</td></tr><tr><td>Coverage:</td><td>0.00 a</td></tr><tr><td>Nudge:</td><td>0"</td></tr><tr><td>Imp. Width:</td><td>60' 00"</td></tr><tr><td>Overlap:</td><td>0"</td></tr><tr><td>Storage:</td><td>595.4 hrs</td></tr></table></div>	Field Name:	083110_0001	Field Area:	0.00 a	Productive Area:	0.00 a	Coverage:	0.00 a	Nudge:	0"	Imp. Width:	60' 00"	Overlap:	0"	Storage:	595.4 hrs
Field Name:	083110_0001																	
Field Area:	0.00 a																	
Productive Area:	0.00 a																	
Coverage:	0.00 a																	
Nudge:	0"																	
Imp. Width:	60' 00"																	
Overlap:	0"																	
Storage:	595.4 hrs																	
	Settings	<p>To collapse the view, continue to tap .</p> <p>Go to the <i>Settings</i> screen to navigate to setup screens:</p> <ul style="list-style-type: none">•  <i>Vehicle</i>•  <i>Implement</i>•  <i>Guidance</i>•  <i>GNSS</i>•  <i>Data</i>•  <i>System</i>																

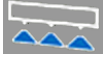











Button	Function	Tap to.../Indicates...
	View	Open view controls.
		Toggle the view from overhead view to trailing view. 
		Toggle the view from trailing view to overhead. 
		<p>Note – By default, the view switches from Overhead to Trailing when you approach the AB line.</p>
		Zoom in
		Zoom out
		Hide the view controls.

Button	Function	Tap to.../Indicates...
	Hide or show controls.	 to show hidden controls.  to hide controls.
	Toggle to show or hide controls.	A shortcut to removing the controls so you can view the guidance line labels.
	Toggle to show or hide controls.	A shortcut to removing the controls so you can view the guidance line labels.
	Opens mapping controls	
	Opens auto steering setup	
	Opens field controls	
	Disengage the automatic steering system	To disengage the auto steering system. Indicates you are currently automatically steering on a guidance line/pattern.
	Indicator only	Indicates the automatic steering system cannot be used.
	Engage the automatic steering	To engage. Indicates the automatic steering is ready to be engaged.





Button	Function	Tap to.../Indicates...
	Activate external video input	
	View full screen external video	To replace guidance screen with video feed. Tap again to resume guidance screen viewing.
	Status of data transfer for Office Sync	<ul style="list-style-type: none"> • If field data is being sent or received, an icon at the top right of the screen displays. • If data is being sent or received, an orange arrow blinks between the tractor and office computer.
 (White)	Status of xFill	Indicates xFill is ready
 (Blue)	Status of xFill	Indicates xFill is engaged, has been used between 0 and 15 minutes
 (Red)	Status of xFill	Indicates xFill is engaged, and 5 minutes remain
	Forward movement	For EZ-Pilot and EZ-Steer® assisted steering system, indicates you are traveling forward.
	Reverse movement	For EZ-Pilot and EZ-Steer system, indicates you are traveling in reverse.



Button	Function	Tap to.../Indicates...
	Coverage logging status	<p>On:  (Green with checkmark)</p> <p>Off:  (Gray with red X)</p> <p>Inactive:  (Gray)</p>
 	Virtual Section Switch for Field-IQ	<p>Shows the current section mode for the controller.</p> <p>Automatic: </p> <p>Manual: </p>
 	Virtual Master Switch for Field IQ	<p>Shows the Master Switch status.</p> <p>On: </p> <p>Off: </p>
 	Section control for Field-IQ	<p>Automatic: </p> <p>Manual: </p>

Feature mapping buttons

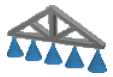

Button	Function	Button	Function
	Pause guidance		Start recording headland
	Nudge left		Pause recording headland
	Nudge right		End headland recording
	Shift AB line		Set A point
	Shift By		Set B point
	Record FreeForm guidance pattern		Next AB line

Setting screen buttons

Tap...	To go to...	To complete functions, including...
	<i>System</i> screen	<ul style="list-style-type: none">• Quick Start Wizard• Display settings• Advanced settings<ul style="list-style-type: none">• Save/Load Configurations• Digital Output• Advanced User Configurations• NMEA Output• Status• About the Display• Restore Defaults• Calibrate Touchscreen
	<i>GNSS</i> screen	<ul style="list-style-type: none">• Set up GNSS, position quality and advanced settings• View status of GNSS, satellite, DGPS
	<i>Data</i> screen	<ul style="list-style-type: none">• Manage Data• Set up Office Sync
	<i>Guidance</i> screen	<ul style="list-style-type: none">• Turn Settings• Coverage Settings• Nudge Settings• Mapping settings• FreeForm Recording• Headland/Infill Switching• Boundary Setup

Tap...	To go to...	To complete functions, including...
	<i>Implement</i> screen	Set up: <ul style="list-style-type: none">• Implement• Application Control• Boom Height Control• Yield Monitoring
	<i>Vehicle</i> screen	Set up and view status of automatic steering

Automatic steering controls

Button/Indicator	Tap to...	Indicates...
 (Yellow)	Engage the auto steering system	System is ready to engage
 (Green)	Disengage the auto steering system	System is engaged
 (Red)	Indicator only	System cannot engage



Adjust aggressiveness

At the *Guidance* screen, tap  to open the control for adjusting aggressiveness.





EZ-Steer and EZ-Pilot: Changing from forward to reverse

The CFX-750 display displays a button indicating the direction you are traveling:

- Forward: 
- Reverse: 

As you are applying material in the field when using EZ-Pilot, you may want to manually move the tractor in reverse. When the tractor moves in reverse, the button switches to .

If the display does not reflect that you are moving in the reverse or forward direction, to indicate to the display the correct direction, tap:

-  if you are moving forward
-  if you are moving in reverse