

Operator's Manual

ULTRA GUIDANCE PSR ISO

Automated Steering System
for tractors and self propelled machinery
in Agriculture and Forestry

Item # 560 144

Version ISO US.12.11.07-001
From SW version PSR_02_145
November 2012
American Version
Printed in Germany

Imprint

All rights reserved
© Copyright by
Reichhardt GmbH Steuerungstechnik
Hofgut Ringelshausen
35410 Hungen / Germany

Phone +49 (0) 6043 - 9645 - 0
Fax +49 (0) 6043 - 4365
Web www.reichhardt.com
E-mail welcome@reichhardt.com

No part of this book may be reprinted, copied or reproduced in any form or by any means without express permission of Reichhardt GmbH.

Any type of reproduction, distribution or storage on data carriers in any form and of any kind not authorized by Reichhardt GmbH represents a violation of national and international copyright laws and will be prosecuted.

Some illustrations may vary slightly from the actual product received. This has no impact on operation or function.

All information, illustrations and technical data in this publication represent the latest available at the time of print. Design changes may take made at any time and without notice.

Responsible party for publication: Reichhardt GmbH Steuerungstechnik

Table of Contents

Remarks	7
1. Safety.....	9
1.1. Intended use	9
1.2. General advice	9
1.2.1. Responsibilities of the owner	9
1.3. Safety symbols and advice.....	10
1.4. Safety decals on the system	10
1.5. Directional information in this manual.....	11
1.6. Demands on operating and service personnel.....	11
1.7. Safety regulations	11
1.8. Danger zone	12
1.9. Preparations for emergencies	12
2. System Description	13
2.1. Various Modes of Operation.....	13
2.2. Base Module	14
2.2.1. PSR vBasic	14
2.2.2. PSR iBasic	14
2.3. Sensor Options.....	15
2.3.1. PSR SKY.....	15
2.3.2. PSR SONIC.....	15
2.3.3. PSR TAC	15
3. Installation of system components	17
3.1. Installation of ISOBUS-Terminal	17
3.2. Installation of PSR iBox	18
3.3. Installation of steering motors	19
3.3.1. Installation of RDU	19
3.3.2. Use of other steering motors.....	20
3.4. Installation of Ultra Sound Sensors.....	20
3.5. Installation of the TAC-Sensor	21
3.6. Installation GPS-Systems RGS-Smart/RGS-RTK.....	22
3.7. Removal of individual components	22

4.	Operation	23
4.1.	Operating interface ISOBUS terminal	23
4.1.1.	Function of the buttons	23
4.1.2.	Function keys	23
4.2.	On and off switch of ULTRA GUIDANCE PSR ISO	25
4.3.	Activation and Deactivation of ULTRA GUIDANCE PSR ISO	25
4.4.	Main screen.....	26
4.5.	Select drive mode	26
4.5.1.	Automatic Drive modes	27
4.5.2.	Drive mode manual	28
4.6.	Reaction setting	29
4.7.	Spacing setting	30
4.8.	Menu structure	31
4.9.	Main Menu	32
4.9.1.	ISOBUS terminal settings	33
4.9.2.	Computer Setting	35
4.9.3.	Set measurements	36
4.9.4.	Setting the GPS receiver.....	37
4.9.5.	Teach-In Menu.....	43
4.9.6.	Diagnostic.....	51
4.9.7.	System Information.....	54
4.9.8.	Service menu	55
4.9.9.	Calculator	56
4.10.	Setting parameters – Adjusting values	57
4.10.1.	Acceptance of values.....	58
4.11.	Numerical entry.....	59
4.12.	Saving changes.....	59

5.	PSR SKY	61
5.1.	GPS mode overview	61
5.2.	Menu structure PSR SKY.....	63
5.2.1.	Main screen PSR SKY.....	64
5.2.2.	Main menu PSR-SKY	66
5.3.	A-B line.....	66
5.3.1.	Setting a straight A–B line.....	67
5.3.2.	Asynchronous tracks.....	69
5.4.	Drive mode Circles.....	72
5.4.1.	Setting circles.....	72
5.5.	Multi-line Mode	74
5.6.	Working with a stored mode	80
5.7.	Set working width.....	81
5.8.	Implement offset setting.....	82
5.9.	Nudging setting.....	83
5.10.	Working with GPS.....	84
5.10.1.	Calibrating a Reference Line.....	84
5.10.2.	Working with Multi-Line	85
5.11.	PSR SKY Quick Start.....	86
6.	PSR SONIC	89
6.1.	Overview Drive mode PSR SONIC	89
6.2.	Menu structure PSR SONIC.....	90
6.3.	Adjusting Sensors	90
6.4.	Main Menu PSR SONIC.....	92
6.4.1.	Sample Spacing SONIC	92
6.4.2.	Joint use of PSR SONIC – PSR SKY	93
6.5.	Set working width.....	94
6.6.	PSR SONIC drive modes.....	95
6.6.1.	Track Cross	95
6.6.2.	Track Outside	96
6.6.3.	Swath Middle/Swath - zig zag.....	96
6.6.4.	Crop Edge	97
6.6.5.	Crop Edge cross wise.....	98
6.6.6.	Crop Edge with correction	99
6.7.	PSR Sonic Quick Start	100

TABLE OF CONTENTS

7.	PSR TAC.....	101
7.1.	Overview Drive mode PSR TAC.....	101
7.2.	Menu structure PSR TAC	102
7.3.	Main screen PSR TAC.....	102
7.4.	Main menu PSR TAC	103
7.4.1.	TAC sensor calibration	103
7.4.2.	Select two TAC sensors.....	104
7.4.3.	Joint use of PSR TAC – PSR SKY.....	105
7.5.	Set working width.....	106
7.6.	PSR TAC Quick Start.....	107
8.	Coupling of drive modes.....	109
9.	Work and Storage Conditions.....	113
10.	Troubleshooting.....	115
11.	Trade Terms and Abbreviations.....	127

Remarks

Thank you for choosing ULTRA GUIDANCE PSR ISO. Please take the time to thoroughly read through this User Manual. It is meant for You the User. It contains all needed information for safe operation and handling of this system. The instructions are based on current regulations for worker safety and health protection, at the time of printing this manual. If you have questions about this steering system that aren't covered in this manual, please consult your nearest dealer or address questions directly to the manufacturer.

Reichhardt GmbH Steuerungstechnik
Hofgut Ringelshausen
35410 Hungen / Germany

Phone +49 (0) 6043 - 9645 - 0
Fax +49 (0) 6043 - 4365
Web www.reichhardt.com
E-mail welcome@reichhardt.com

To understand the Operator's Manual

While reading this manual, please consider the following:

Illustrations may vary from the actual components used. This may be due to different operation modes, or software versions. When ISOBUS terminals are used, hardware pictures may vary due to various placement options, and have no impact on functioning the system.

Always use original parts

Reichhardt original spare parts are designed for this steering system. They live up to highest standards of safety and reliability. Components or parts that are not provided by Reichhardt should not be used for this system because they might jeopardize the safety and function of the system. Therefore, we can not be responsible for any redesign or adaptations. Any obstinate changes on the steering system voids company warranty. In addition, conformity declaration (CE Symbol) or local authority regulations could be voided. This also applies to the removal of factory applied seals.

1. Safety

1.1. Intended use

This automatic steering system is designed to be controlled by persons working in agriculture or forestry including special cultures like vineyards, fruit trees, or vegetables. Any usage beyond recommendations is therefore prohibited. ULTRA GUIDANCE PSR ISO is not suitable for applications on narrow dikes or steep hillsides, when danger of vehicle roll-over exists. It should not be exposed to areas that are in danger of explosions. Never expose the unit or individual components to chemicals such as: acids, lye, oils, lubricants or other aggressive petro-chemical materials. The manufacturer is not responsible for any damages relating to non-purpose oriented usage. The risk is the sole responsibility of the user. These purpose oriented conditions also apply to recommended operator regulations as well as service and maintenance directions.

1.2. General advice

Please read this manual thoroughly. This steering system is fabricated under respected technical regulations and expertly installed. In this manual you receive all the information required for proper operation and maintenance of the system. Please observe all reference points and directions exactly. Failure to do so could lead to personal injury or equipment damage. This manual and safety decals may also be available in other languages. Check with your dealer or our internet website.

This manual is considered a permanent part of the steering system and shall remain with the steering system in the event that it is sold to other parties.

Measurements in this manual are given in US Standard. Make sure to use correct tools.

If original brackets or parts are not used, it could potentially lead to injury or material damage caused by malfunction of the steering system. Therefore, always use approved brackets and spare parts.

1.2.1. Responsibilities of the owner

Only persons who have read and understood the complete manual should work with this system.

Only persons which are comfortable with installation, service and repair of the steering system, and also aware of possible dangers in conjunction with the job, should use the system.

Regional regulations for health protection and accident prevention must be obeyed at all times and while working with the system. Never use the system on public roads or highways.

Any changes to the steering system which are not authorized by the manufacturer, void any liability of the manufacturer in the event of a malfunction.

If you do not understand any part of this manual and need assistance please contact your dealer.

1.3. Safety symbols and advice

In this manual, the following safety symbols and caution signs are used. You are being warned about possible personal or material hazards. There are also tips to reduce stress.



Danger! This symbol warns of imminent threat of danger which could lead to serious bodily harm or death. This danger can appear when operator manuals and instructions are not being followed.



Warning! This symbol warns of a dangerous situation that could lead to serious bodily harm or death. This danger can appear when operator manuals and instructions are not being followed.



Attention! This symbol warns of potentially dangerous situations which could lead to bodily harm, damage to the machine or other major material damages. Disregard of these safety instructions can lead to loss of the warranty. This danger can appear when operator manuals and instructions are not being followed.



Advice! This symbol warns of material damage or directs your attention to tips and advice which may lighten your work load. Heeding this advice leads to more comfortable work and longer life expectancy of this equipment.

1.4. Safety decals on the system

All potentially dangerous spots on the system are also identified with warning decals (pictogram). These pictograms advise of potential dangers. They are part of the contents of this manual. Keep safety signs in good, clean, and readable condition. Be sure new components or parts include the current safety signs. The meaning of various pictograms is explained in the following text.

If needed, new decals can be ordered through a local dealer.



Attention! Read and observe the manual and safety instructions prior to operation.



Warning ! On all public roads and highways the automatic steering ULTRA GUIDANCE PSR ISO must be deactivated.

1.5. Directional information in this manual

Right-hand and left-hand sides are determined by facing in the direction of forward travel.

1.6. Demands on operating and service personnel

Every person operating or servicing this system must meet the following minimum requirements:

- He/she is physically capable of controlling the machine.
- He/she is able to safely perform the work with the machine and system as specified in this operating manual.
- He/she understands the functionality of the machine and system within the scope of the work and can recognise and avoid the related hazards.
- He/she has understood the operating manual and can implement the information contained therein accordingly.
- He/she is familiar with the safe operation of vehicles.

1.7. Safety regulations

With exception of the driver, no other person should ride in the driver's area of the vehicle fitted with the steering system. Additional persons could distract or block visibility of the driver and prevent him from operating and observing the steering system.

The presence of a rider on a passenger seat is only acceptable for brief observations or training purpose. The passenger seat is never considered a children's seat. Only experienced persons, with the operation of the machine, should be considered for schooling on a machine which is fitted with the steering system.

Pay special attention that no children are near or on the vehicle, which is fitted with the steering system. This is important to be aware of as soon as the motor is running. Children are unpredictable and supervision is limited when operating the steering system.

Before starting field work, get comfortable with the use of the system and the vehicle. As soon as the steering system is activated, a responsible adult must be in charge of supervision and monitoring. In dangerous situations it is always safer to turn off the system and drive by hand in order to avoid personal injury or material damage. The steering system is automatically deactivated when the driver's seat is abandoned. Use the main switch to additionally shut it off.

Be prepared to steer by hand at the end of the field or track, since the system is not able to turn the machine on the headland.



Warning! Never activate the steering system while driving on public roads! For safety reasons, it is advised to keep at least one hand on the steering wheel when using the steering system at speeds higher than 6 mph. In the event of a malfunction, action can be taken immediately.

1.8. Danger zone

At no time should there be any person within the danger zone after the steering system is activated. This danger zone is shown in the following illustration. At any sign of danger the operator should deactivate the steering system immediately. The operator can reactivate the steering system once the danger zone is clear.

For service and control duties, only authorized persons can enter the danger zone after receiving verbal confirmation with the operator. Such people have to be clearly informed about possible dangers before entering the danger zone. All activities between the operator and these persons should be discussed beforehand. All service, calibrating, and control duties on the steering system should only take place, if technically possible, on a parked vehicle with the engine turned off. It is the operator's responsibility that the vehicle can not be started inadvertently by untrained persons without previous verbal agreement.

Danger zone:

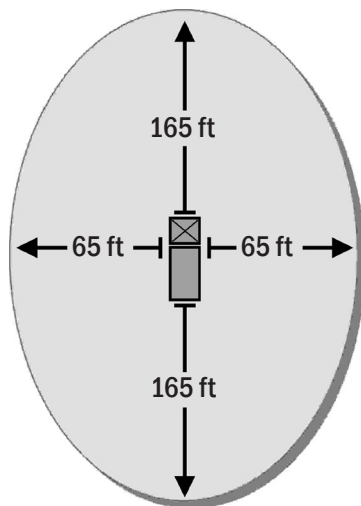

Danger! People present within the danger zone may be exposed to serious bodily harm or even death. People could be run over in the event of a possible machine malfunction. The operator is obligated to stop the vehicle as soon as people enter the danger zone.

Beware of defective or electronic lines which are not securely attached. These can cause fatal electric shocks.

Defective hydraulic lines or those which are not securely fastened can become loose and toss wildly around. High-pressure hydraulic oil can leak and cause serious injuries to the skin or face.

Preparations for emergencies

Prepare for possible emergencies:

- Always have a fire extinguisher and First Aid Kit on hand.
- Always have emergency phone numbers for fire department, ambulance and doctor on hand.

2. System Description

ULTRA GUIDANCE PSR ISO is an automatic steering system for all vehicles which feature full hydraulic steering capability or for vehicles which are set up preliminary for an ISO compatible automatic steering system. It is possible to automatically steer self propelled machinery in applications like farming, forestry and specialty crops like vegetables.

ULTRA GUIDANCE PSR ISO uses various sensors depending on the mode of operation to steer a vehicle along existing tracks, structures or with the help of satellite supported positioning.



Attention! ULTRA GUIDANCE PSR ISO is designed to support the driver to operate the machine more efficiently. When using the ULTRA GUIDANCE PSR ISO, the driver is obligated to observe his surrounding area and the machine. He should shut down the system in any dangerous situation, and revert to steering by hand.

2.1. Various Modes of Operation

ULTRA GUIDANCE PSR ISO has three different application modes:

1) PSR hBasic integrates the steering system into the hydraulic system of the vehicle. It can operate with various hydraulic systems (constant flow or load sensing).

Advantages:

- Base installations on various vehicles for simple quick change of components.
- Improves steering performance through quick response times.
- Ideal for operating speeds exceeding 10 mph.

2) PSR eBasic utilizes an electric motor to activate the steering wheel.

Advantages:

- Simple installation.
- Inexpensive base installations.
- Ideal when using several vehicles.

3) PSR ISO means, that the steering valve is controlled via the existing ISOBUS in the vehicle. It is therefore suitable for all vehicles which are set up preliminary with ISOBUS steering.

Advantages:

- Plug-and-Play simple installation.
- Base installation.
- No mechanical changes on the vehicle.

2.2. Base Module

2.2.1. PSR vBasic

PSR vBasic is the basic hardware which will be integrated into the vehicle. It is composed of the wiring harness and mounting brackets for the iBox.

PSR vBasic stays with the vehicle in which it was installed.

2.2.2. PSR iBasic

PSR iBasic is the intelligent component of ULTRA GUIDANCE PSR ISO and consists of:

PSR iBox – is the core component of ULTRA GUIDANCE PSR ISO. With a PSR-controller, the weather proof distribution box steers all functions of ULTRA GUIDANCE PSR ISO. The PSR iBox is installed for easy access outside of the tractor cab. Suitable mounting brackets are contained in the PSR vBasic. The iBox is lockable and provides dirt and weather protected connections for trouble free function even when changing vehicles.

ULTRA GUIDANCE PSR ISO can be operated by any ISOBUS terminal.



Picture 1:
PSR iBox

2.3. Sensor Options

2.3.1. PSR SKY

PSR SKY is satellite supported high accuracy steering utilized in all applications where exact parallel tracking without existing plant rows, ridges or tram lines is possible. It may be used for increased efficiency by using full implement width in every pass. Pending customer preference, the satellite receiver can work with WAAS-, Beacon-, OMNISTAR-, EGNOS (L-Band) or RTK corrected signals. PSR SKY is also compatible with other satellite receivers which the customer may already have, provided the transmission rate 19200 Baud, NMEA 0183 compatibility and an update rate of at least 5 HZ.



Picture 2:
PSR SKY

2.3.2. PSR SONIC

PSR SONIC is a driving option for precise steering along existing tracks, plant rows, ridges, or marker tracks. Sonic sensors can read many different physical structures. They are hand adjustable. With an accuracy of 1 1/4 inches, PSR Sonic is uniquely suitable for seeding, transplanting, maintenance and harvesting field and vegetable crops.



Picture 3:
PSR SONIC

2.3.3. PSR TAC

PSR TAC is the system with the greatest precision. Unique low-wear plastic paddles gently and precisely detect vegetation in closed row crops.

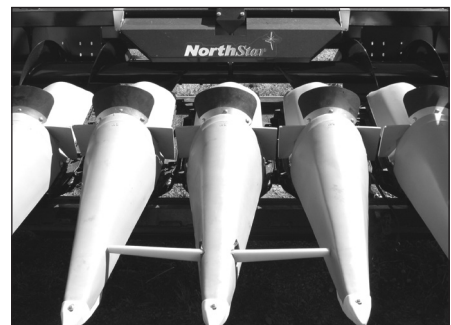

Picture 4:
PSR TAC

3. Installation of system components

Following strict industry standards and safety regulations, ULTRA GUIDANCE PSR is professionally assembled and installed before it gets used for field operation.

The PSR iBox and various sensors can be exchanged between eight different vehicles.

Any vehicle intended for ULTRA GUIDANCE PSR ISO has to have PSR vBasic installed. The initial installation has to be done by personnel trained and authorized by Reichhardt for this product. In this manual we describe only the installation of system components into vehicles which are already auto steer ready.



Attention! Turn off ULTRA GUIDANCE PSR ISO before attempting any installations by switching the main switch off (see chapter 4.2.).

After each hardware installation, test the complete system function with the diagnostic program (see chapter 4.9.4.). This will help to avoid malfunction through, for example, poorly fitting electric connections.

Make sure to protect connectors after each component change, by using blind caps and plugs to prevent contamination.



Warning! Sharp edges or moving parts can lead to hand or skin injuries (crushing, fissures, effusions of blood).

3.1. Installation of ISOBUS-Terminal

In case the ISOBUS terminal should be moved from one vehicle to the other, please gather information in the operator's manual of the terminal manufacturer.

3.2. Installation of PSR iBox

A portion of the vBasic is the mounting bracket of the PSR iBox. It will be permanently installed in the vehicle and is available for further usage.



Advice! In order to protect the connectors from moisture and dirt, and assure optimum contact during the next operation, always screw on blind caps and plugs (see adjacent figure).

The PSR iBox is easily installed by following these instructions:

1. Insert the tabs on the upper edge of the mounting bracket into the cut-out's on the backside of the PSR iBox (see Picture 6).
2. Flip the PSR iBox down (see Picture 7).
3. Grab the latch and insert the hook into the slot provided (see Picture 7) and rotate the latch (see Picture 8) to lock.
4. Insert the cable connectors X_A and X_B into the bottom of the PSR iBox.
5. Make sure that both cables X_A and X_B are properly inserted and locked with the locking slide provided.



Picture 5:
Mounting plate PSR iBox



Picture 6:
Step 1: Positioning



Picture 7:
Step 2: Inserting



Picture 8:
Step 3: Locking



Attention! Make sure that the latches on both sides of the PSR iBox are tightly connected to the mounting bracket.

3.3. Installation of steering motors

3.3.1. Installation of RDU

The Reichhardt Steering Motor RDU will be expertly installed and turned over to the customer field-ready.



Advice! Any time the steering motor is not in use, while on the road or when stopped, lock it into the inactive position so there is no contact to the steering wheel. That way the life expectancy of the steering motor RDU and its contact wheel will be greatly extended.

To install the RDU into another vehicle

- Push the mounting slider onto the holding bracket.
- Slide the holding bracket of the RDU between the steering column and the mounting slider.
- Slide the motor unit close the steering wheel so that the contact wheel, in the non action position, is approximately 1 3/4" inches.
- Fasten the RDU in this position to the steering column bracket. Tighten the thumb screw beneath the slider by hand. Do not use any tools.
- Connect the connector cable of the RDU motor to the cable harness of the vehicle.
- To activate automatic steering grab the motor friction wheel and push it away from the steering wheel. The locking device releases, and the motor is drawn towards the steering wheel. The RDU steering assistant is now operation ready.
- During active operation, if the steering wheel is not getting enough force, the contact pressure may be too low. Slide the RDU motor closer to the steering wheel or increase the spring tension.



Advice! By marking the optimal position on the mounting bracket now, it will be useful to refer to it during the next vehicle installation.



Attention! Keep hair, clothing, gloves, necklaces and other jewellery away from moving parts! Long hair, loose clothing, jewellery or similar loose parts can become caught in moving components.

Do not insert your fingers between the mounting base and mounting slider. This can cause injuries.



Picture 9:
Slide RDU into the mounting slider

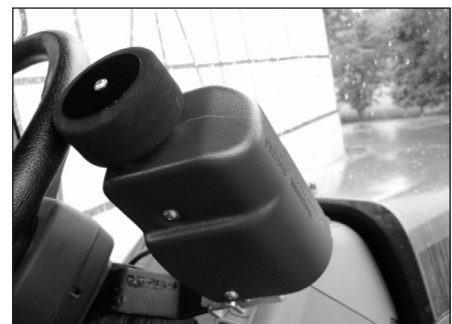

Picture 10:
RDU in operating position

3.3.2. Use of other steering motors

Steering motors of competitive brands can be integrated into the Reichhardt steering system, if it is technically possible. Reichhardt will provide the necessary cables and adapters. The installation and adaptation to other vehicles is described in the operator manual of the manufacturer of such motors.

3.4. Installation of Ultra Sound Sensors

Sensors do not require programming prior to use.

When switching vehicles, installation follows the same guide lines as used during first installation. After installation the connector plug of the sensors is inserted into the receiver of the vehicle. The placement and angle of the sensors depends on the field application (see chapter 6.1.).



Advice! The gauge reading measurements in the diagnostics program (see chapter 4.9.6.) should range between 20 and 28 inches. When the sensor is properly aligned with the guide structure/tram-line, it will find a reading of 59 inches. In case the sensor is not positioned correctly or defective, swing it to a different position and test it again.



Picture 11:
Sonic sensors side by side



Picture 12:
Sonic sensors behind each other

3.5. Installation of the TAC-Sensor

Normally the TAC-Sensor is permanently installed by authorized service into the corn header or other devices. The sensor cable plug needs to be connected to the receptacle on the vehicle.

The TAC-Sensor may be installed with a special mounting bracket. Make sure to install it as directed by Reichhardt service personnel.

Connect the sensor cable plug to the receptacle on the vehicle. Depending upon various applications, make sure that the TAC-Sensor receives proper side to side adjustment, since it should be centered between rows.

Information for operation of the TAC-Sensor is found in chapter 7.



Advice! If the TAC-Sensor is completely removed, pay attention during reinstallation that the rounded part of the sensor housing is pointing forward and the connector plug is on the right-hand side in the back.

The paddles are always mounted with the square edge pointing up.

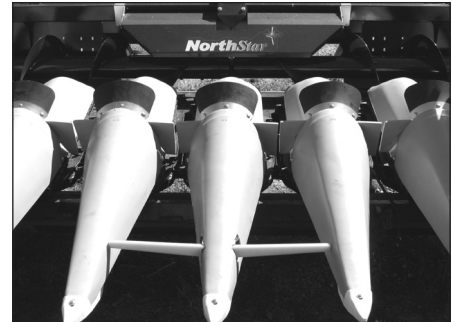

Picture 13:
TAC-Sensor in working position

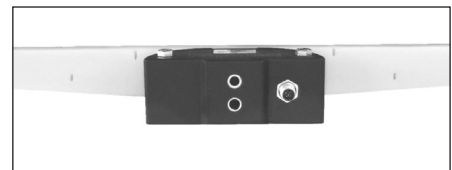

Picture 14:
TAC-Sensor

3.6. Installation RGS/GPS-Systems

Place the RGS 100 receiver with the magnetic foot on top of the mounting plate on the vehicle. Place the RGS 320 receiver on to the mounted bracket and tighten it.

After the GPS receiver is mounted, route the receiver cable and connect it with X_{19} on the cable harness X_B and X_{09} on the cable harness X_A (only with RGS-RTK).



Advice! Pay attention when routing the cable that it does not get exposed to sharp corners or edges to avoid chafing. Also make sure it is free of mechanical loads such as tension.



Attention! Depending how the system is configured by authorized service, the GPS system could be under constant electric load. This could slowly drain the vehicle battery during lengthy interruptions of the operation. As soon as the PSR iBox is removed from the vehicle, the electric current to the GPS receiver is interrupted. If the electric current of the GPS receiver comes through the PSR iBox, the electricity to the GPS receiver is interrupted as soon as the system is switched off. 20 to 30 minutes of warm-up may be required when restarting.



Picture 15:
 Reichhardt RGS 100 receiver



Picture 16:
 Reichhardt RGS 320 receiver

3.7. Removal of individual components

The de-installation of individual components follows in reverse logical order as described in the installation directions.



Advice! During disassembly make sure to properly close plugs and receivers with provided blind covers.



Attention! Connect the cable X_A and X_B to the blind connectors on the bracket for the PSR-iBox and lock in place with the safety slide.

4. Operation

4.1. Operating interface ISOBUS terminal

All settings are made via the ISOBUS terminal.

The display is split in two areas:

Zone **A**: Contains information to the current drive mode.
 Zone **B**: Function keys for operation.

The input is menu directed and multilingual over five function keys, which change their function depending on the displayed symbols in zone **B**. Details are found within the appropriate drive modes.

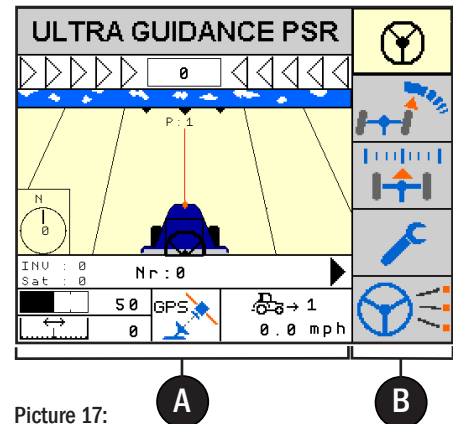

Picture 17:
Main screen

4.1.1. Function of the buttons

Two additional functional zones are located within the information display:

Zone **C**: Button for accessing and advancing information on the respective job.
 Zone **D**: For changing desired tractor color.

The selected function is displayed by the button in the shape of a square frame.



Advice! You can find information in the manual to your ISOBUS terminal which shows you how to change the button in the main screen.

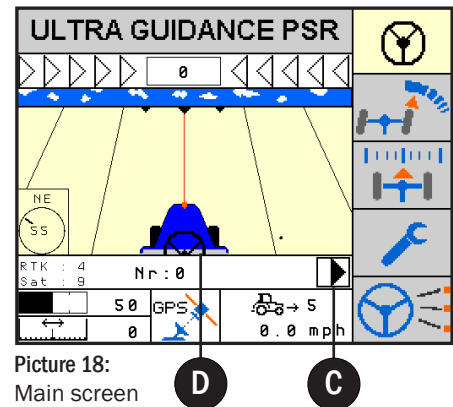

Picture 18:
Main screen

4.1.2. Function keys

The touching of function key **B** result in one of the items listed here:

Activate/deactivate steering



= Error message: steering cannot be activated.



= Automatic steering deactivated.





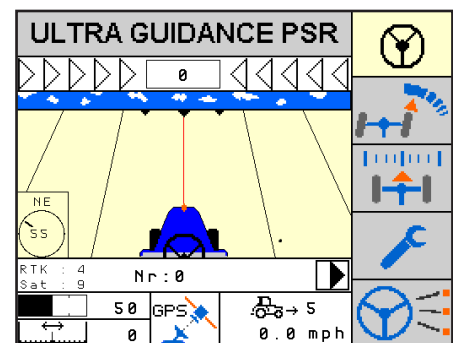

= Automatic steering activated.





Picture 19:
Main screen

CHAPTER OPERATION

Plus / Minus key  
 • Changes numerical values.

Arrow right / left  
 • Scrolls through the menus.
 • Functions as electronic dial.

Arrow up / down  
 • Scrolls through the menus.

Enter key 
 • Confirms the selected menu selection/input.

Reaction Setting 
 • Changes in the menu reaction setting.
 • Confirms the set reaction level.
 • Switches to the next multi-line.

Re-Center/Nudge 
 • Enters the re-centering menu.
 • Modifies nudge value.
 • Calibrates the reference line in GPS.

Main Menu 
 • The main menu switches in the main screen.
 • Switches into the Teach-Menu of the corresponding drive mode when briefly pressed.

Drive Mode Setting 
 • Allows you to change the drive mode.
 • Confirms a selected drive mode.
 • Switches between automatic steering and the dial.

Escape 
 • Jumps back by one menu level or interrupts actual input and returns to previous setting

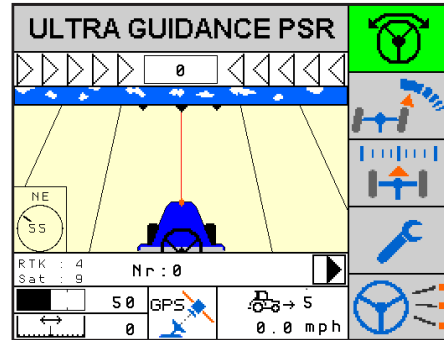

Picture 20:
 Main screen

4.2. On and off switch of ULTRA GUIDANCE PSR ISO

By pressing the main switch ULTRA GUIDANCE PSR ISO is activated. Depending on the vehicle an applicable main switch is installed. Please ask the service technician where the main switch was installed.

Read the safety instructions and confirm by pressing the Enter key .



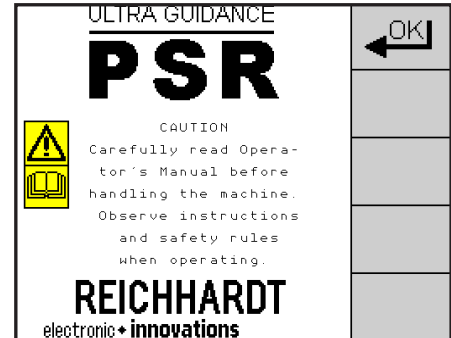

Attention! ULTRA GUIDANCE PSR ISO has to be turned OFF at the end of field work and before entering public roads by the main switch.



Picture 21:
 Safety information

4.3. Activation and Deactivation of ULTRA GUIDANCE PSR ISO

By the displayed symbol of the function key **A** you see the current status of the steering system. The symbol  shows, that ULTRA GUIDANCE PSR ISO is active. If you see symbol  PSR ISO TOP is deactivated.

Activating ULTRA GUIDANCE PSR ISO:

The system can only be activated when the main screen is on.

- By pressing the function key .
- By activating the foot switch.
- By the menu TL-TOP.

Deactivating ULTRA GUIDANCE PSR ISO:

- By pressing the function key .
- By the menu TL-TOP.
- By activating the foot switch.
- By switching the main switch ON/OFF.
- By manually moving the steering wheel.

The system will deactivate automatically:

- When driving speed is too high.
- When experiencing a system malfunction.
- When opening the cab door or leaving the drivers seat (if activated at set up).

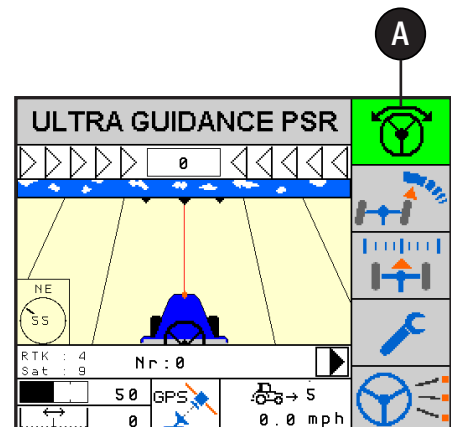

Picture 22:
 Main screen (steering activated)

4.4. Main screen

The display on the main screen is dependent on the current application.

A - Spacing

Display of the actual center offset setting.

B - Reaction level

Display of the actual reaction level setting for the selected drive mode.

C - Drive mode

Display of the current drive mode.

D - Information display

Main information display.

E - Vehicle information

Display of the vehicle number and actual drive speed.

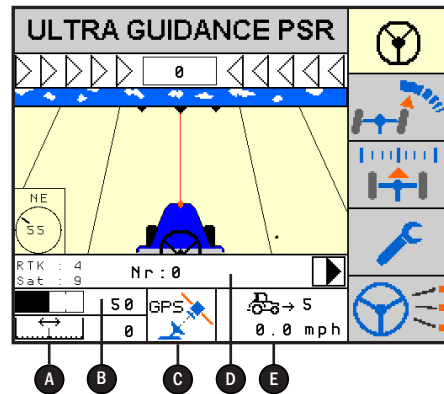

Picture 23:
 Main screen GPS

4.5. Select drive mode

ULTRA GUIDANCE PSR ISO represents auto steering by utilizing various guide line sensing devices. The guide line comprehension depends on the sensor and is described as drive mode. Before working with ULTRA GUIDANCE PSR ISO, set the desired drive mode. PSR-SKY and PSR-TAC identify already the respective drive mode. There are 9 drive variations for the ULTRA SONIC mode. The differences are identified by the mounting of the sensors.



4.5.1. Automatic Drive modes

Display: Main screen

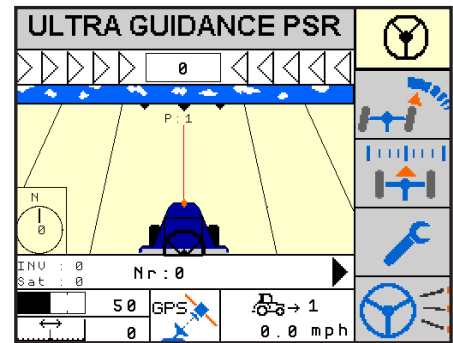
Press the function key  until the symbol flashes.



Picture 24:
Main screen

Select by the function keys ,  the desired drive mode.

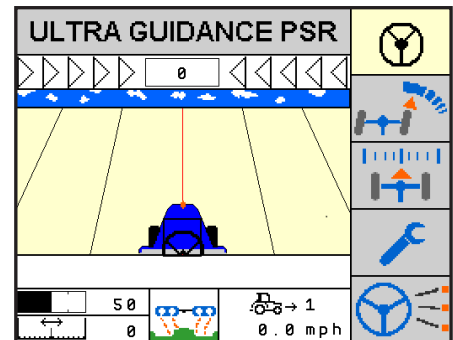

Picture 25:
New drive mode selected

Press the function key  briefly to store the selected drive mode and to return to the main screen.





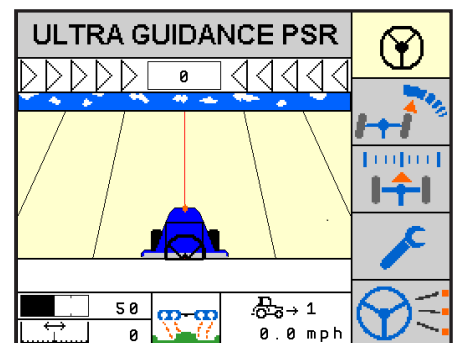





Advice! If the drive mode setting is not completed correctly, the selected drive mode is reject and the previously set drive mode remains activated.





Picture 26:
New drive mode activated

CHAPTER OPERATION

The following drive modes are available depending on the selection of the system. (Detailed information about various drive modes are found in respective chapters):

PSR TAC	
PSR SKY	
PSR MEC (not available in Europe)	
PSR SONIC Swath in center/ swath zig zag	
PSR SONIC drive track cross wise	
PSR SONIC drive track outside	
PSR SONIC crop edge with correction left/right	
PSR SONIC crop edge cross wise left/right	
PSR SONIC crop edge left/right	

4.5.2. Drive mode manual

A quick touch of the function key  can switch between automatic steering or manual steering mode. The vehicle can now be steered with the function keys   (steering by wire).

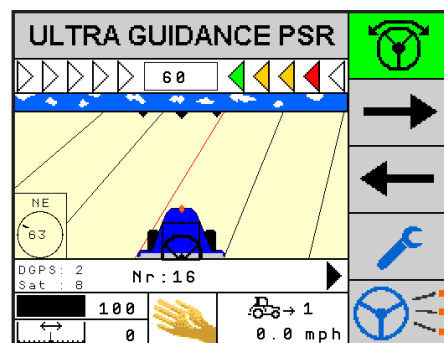

Picture 27:
 Steering by wire activated



4.6. Reaction setting

Display: Main screen

Reaction identifies the sensitivity of the steering system in relationship to movements of the vehicle. HIGH means very sensitive (steering reaction will be aggressive), LOW means less sensitive (the steering reaction will be gentler).

With the steering reaction low the vehicle will make gentle steering adjustments. With a higher reaction setting the vehicle steering reaction is increased.

Press the function key  until the symbol flashes.

By pressing the function keys  , the operator can increase or decrease the steering reaction level. The range of settings goes from 0% to 100%. The setting information will be stored with the actual drive mode in the system.

➔ **Advice!** To press the function key  will disengage the steering system when changing the reaction setting.

Tap the function key  to store the reaction level.

➔ **Advice!** If there is no input for 30 seconds the menu automatically returns to the main screen. The current reaction level will be stored.

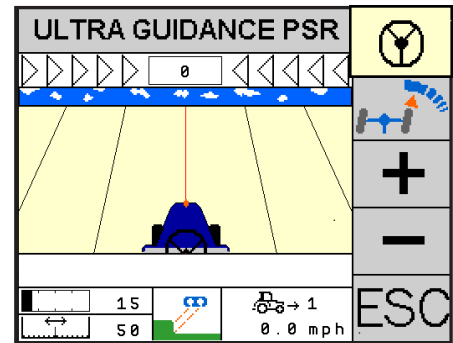

Picture 28:
 Reaction level low

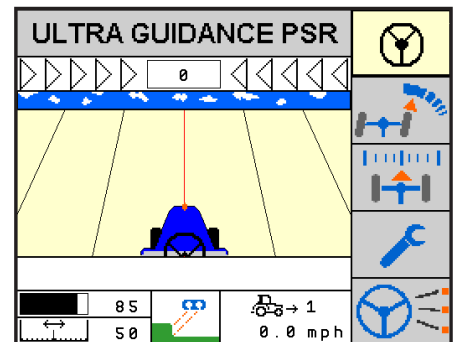



Picture 29:
 Reaction level normal



4.7. Spacing setting

Display: Main screen

Spacing identifies the distance of the machine to the default line. The setting of these values are needed to allow the implement to continue to seamlessly work lines.

Press the function key  until the symbol flashes.

Pressing the function keys   sets the distance. The range of settings is between + 12 and + 35 inches for the distance to the crop edge. Or between -20 and +20 inches for the distance to the center of the vehicle. The setting information will be stored with the actual drive mode in the system.

 **Advice!** Pressing the function keys   will disengage the steering system when changing the spacing setting.

Tap the function key  to store the spacing level.

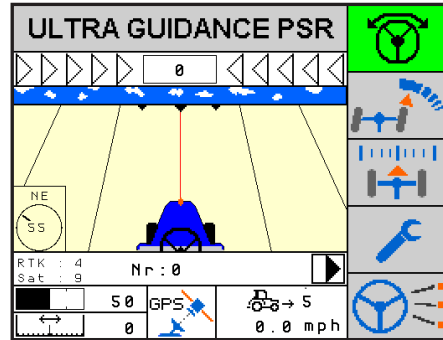

Picture 30:
 Drive mode with center offset

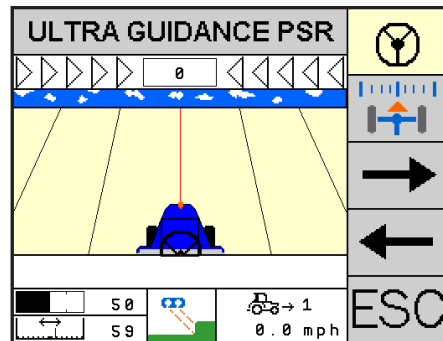

Picture 31:
 Drive mode with distance to the crop edge

4.8. Menu structure

ULTRA GUIDANCE PSR ISO is steered with the help of stored menus. The menu in the PSR cBox is built up on 4 levels for simple operation, and easy understanding in many different languages.

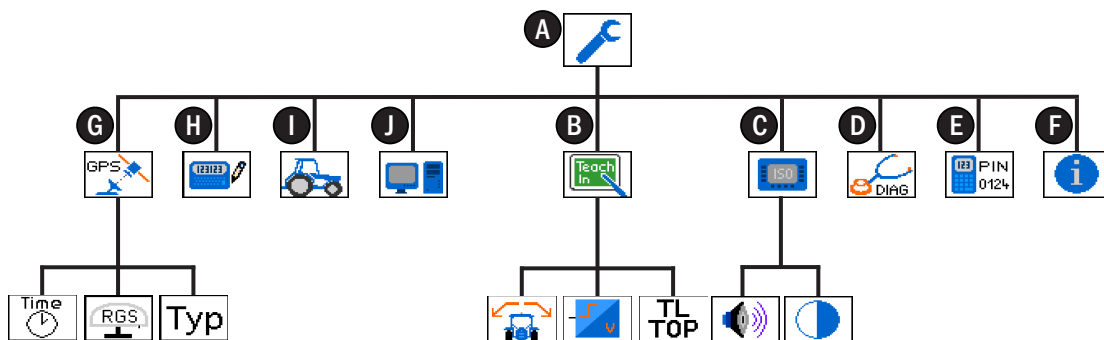

Picture 32:
 Menu structure

- A** – Main Menu
- B** – Teach-In
- C** – Terminal
- D** – Diagnostic
- E** – Service menu
- F** – System information
- G** – GPS receiver settings
- H** – Calculator
- I** – Vehicle number
- J** – Computer settings



4.9. Main Menu

Display: Main screen

Press the function key  until the main screen shows up at the display.

The upper line in the main menu shows in which position the system is presently set. The lower line shows the related menus.

As illustrated the field in the middle (current selection) is accentuated by a bold frame.

Press the function key ,  to browse to the required symbol. Press the function key  to select the accentuated field.

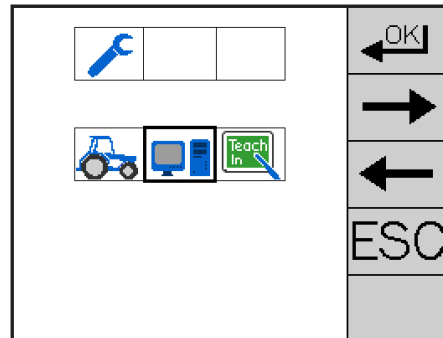

Picture 33:
Main menu

4.9.1. ISOBUS terminal settings

At the ISO operating unit the operator can adjust sound level and contrast. Choose  and confirm the selection.

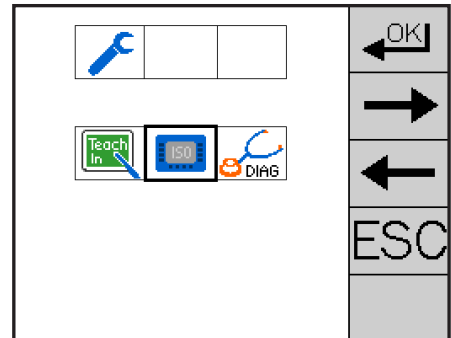

Picture 34:
Settings ISO operating unit

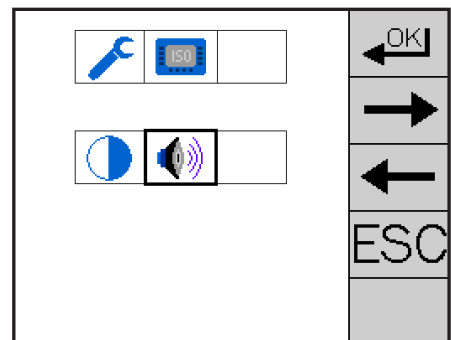

Sound level setting

Choose  and confirm the selection.



Picture 35:
Choose sound level

The setting of the actual loudness of the sound strength shows in bars on the monitor.

Press the function keys   to adjust the sound to the desired level. Each new level is checked by a control sound with the new setting.

Press and hold the function key  until the save screen appears. Proceed as described in chapter 4.12.

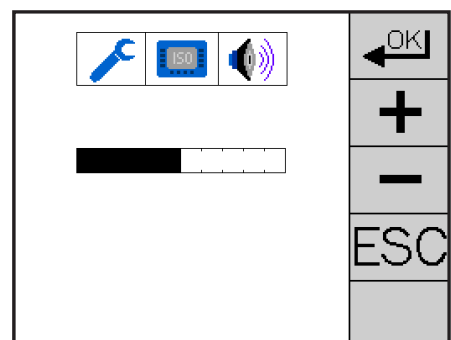

Picture 36:
Set sound level

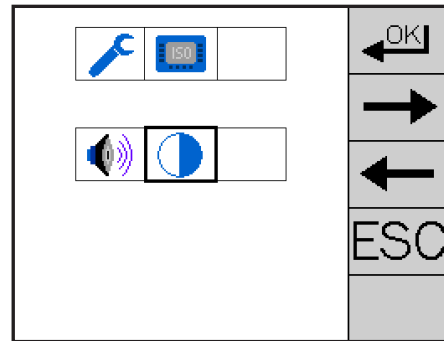

Contrast adjustment

Choose  and confirm the selection.



Picture 37:
 Choose contrast

The contrast for the display is shown on the monitor.

Press the function keys   to set the desired contrast. You already see the modification while you enter it.

Press and hold the function key  until the stored symbol appears. Proceed as described in chapter 4.12.

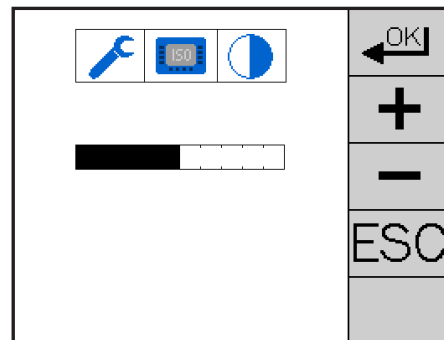

Picture 38:
 Set contrast

4.9.2. Computer Setting

This is the area where language and measurement unit are set.

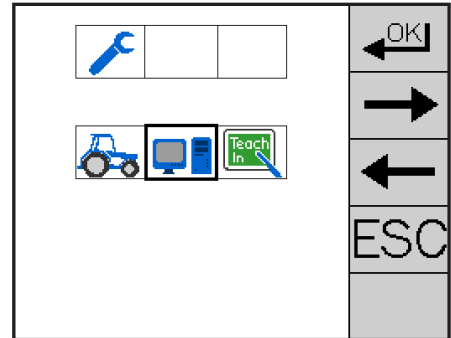

Choose  and confirm the selection.

 **Advice!** The language and units of the ISO terminal settings are always accepted. Please consult the manual of the respective ISO terminal manufacturer for more information.



Picture 39:
 Select Computer settings

Set language

Press the function keys ,  for parameter “No: 5” and adjust the value, as described in chapter 4.11., to the requested one.

No: 5 = language

Val: 0 = German

Val: 1 = English

Val: 2 = French

Val: 3 = Dutch

Val: 4 = Polish

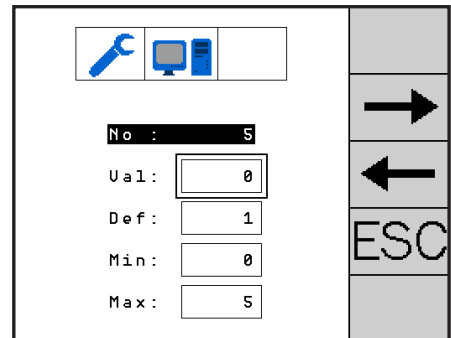

Val: 5 = Romanian

Val: 6 = Spanish



Picture 40:
 Set language

Enter settings

Press the function keys ,  for parameter “No: 6” and adjust the value, as described in chapter 4.11., to the requested one.

No: 6 = measurement unit

Val: 0 = metric

Val: 1 = US Standard

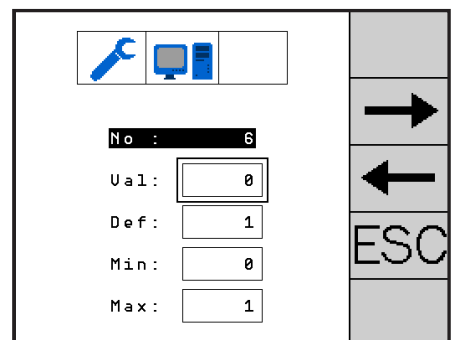

Picture 41:
 Set measurements



4.9.3. Set measurements

ULTRA GUIDANCE PSR ISO can store settings of up to eight different vehicles. All vehicle settings will be stored under one number. When switching the PSR iBox to another vehicle, choose the vehicle number under which the stored information is found.

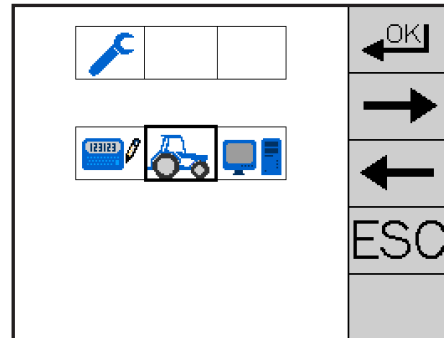
Choose  and confirm the selection.



Picture 42:
 Set vehicle number

Press the function keys   to select the required vehicle number.

Press and hold the function key  until the stored symbol appears. Proceed as described in chapter 4.12.

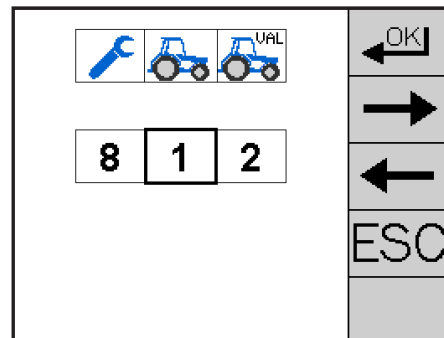

Picture 43:
 Selection of vehicle number

4.9.4. Setting the GPS receiver

In order to connect a GPS receiver to the automatic steering system, settings must be made accordingly.

➔ **Advice!** A GPS receiver is required for PSR SKY operation. In addition, the GPS receiver can be used as a speed sensor for all other drive modes.

Choose  and confirm the selection.

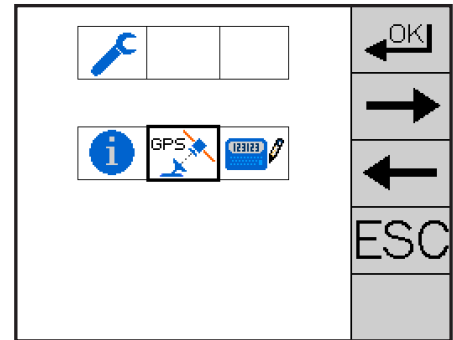

Picture 44:
 Selecting set GPS receiver



Setting the RGS receiver

RGS receivers refer to GPS receivers which can be purchased directly from Reichhardt. The distinction is made here between GPS receivers which process DGPS correction signals and those which are RTK capable. This affects the precision which you can obtain with your steering system.

The settings of the RGS receiver can be adapted to your personal applications. The RGS receiver has 2 ports. An ULTRA GUIDANCE PSR ISO is connected to the port "PSR". The port "Other" is freely available for your personal requirements, e.g. for surveying.

➔ **Advice!** These functions are only available to you if you use an RGS receiver.

Choose  and confirm the selection.

➔ **Advice!** If  is not visible, **Typ** must be set to .

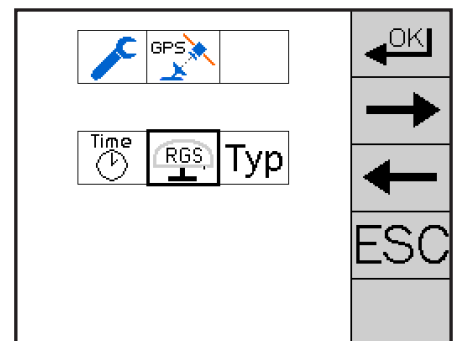

Picture 45:
 Setting set RGS receiver

Setting port “PSR”

Choose **PSR** and confirm the selection.

➔ Advice! For ULTRA GUIDANCE PSR ISO, it is recommended to set RMC messages to 10Hz and GGA messages to 1Hz. All other messages should be set to “off”.

Press the function keys   to select the desired setting.

Briefly press the function key  to change the setting.

Press and hold the function key  until the stored symbol appears. Proceed as described in chapter 4.12.

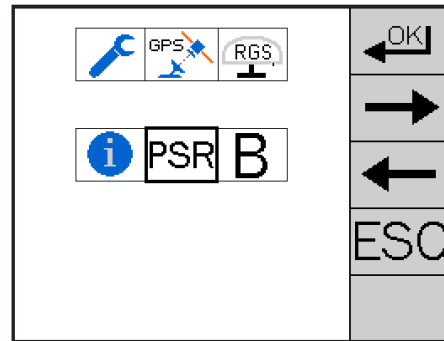

Picture 46:
 Selecting port “PSR”

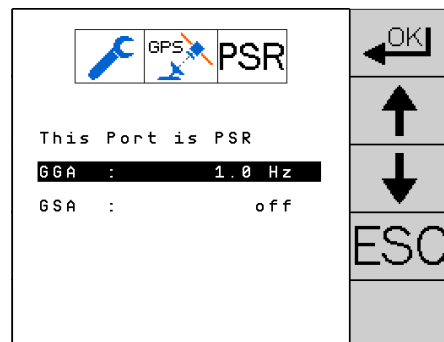

Picture 47:
 Setting port “PSR”

Setting port “OTHER”

Choose **B** and confirm the selection.

This port is freely available to you and can be set according to your needs. You can make the following settings:

- GGA : 0.2 - 10Hz
- GSA : 0.2 - 10Hz
- RMC : 0.2 - 10Hz
- ZDA : 0.2 - 10Hz
- VTG : 0.2 - 10Hz
- GLL : 0.2 - 10Hz
- GSV : 0.2 - 10Hz
- GST : 0.2 - 10Hz
- RRE : 0.2 - 10Hz
- Baud: 4800 - 115200 baud

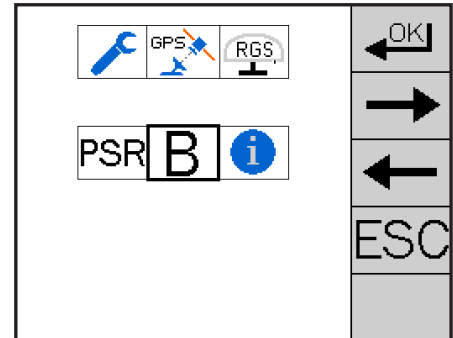

Picture 48:
 Selecting port “OTHER”

Press the function keys **↑**, **↓** to select the desired setting.

Tap the function key **←OKJ** to change the setting.

Press and hold the function key **←OKJ** until the stored symbol appears. Proceed as described in chapter 4.12.

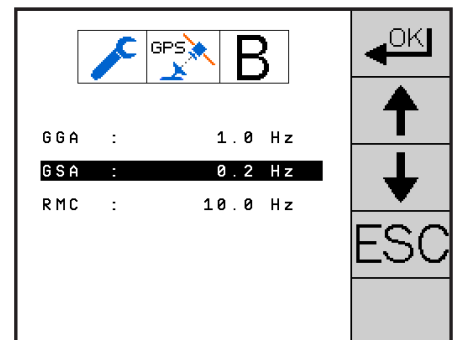

Picture 49:
 Setting port “OTHER”

General RGS receiver settings

Choose  and confirm the selection.

In this menu general settings for the GPS receiver are made. You can make the following settings:

- NP : number of decimal places, 5 - 7 possible.
- Appl : Shift application. Depends on GPS receiver, e.g. RTK <-> WAAS/EGNOS
- PRN 1: Reference satellite 1
- PRN 2: Reference satellite 2
- Diff : Difference mode. Depends on GPS receiver.

Press the function keys   to select the desired setting.

Tap the function key  to change the setting.

Press and hold the function key  until the stored symbol appears. Proceed as described in chapter 4.12.

 **Advice!** The setting for “NP” always should be set to 7. This way you receive the highest accuracy for the positioning of the GPS receiver.

 **Advice!** PRN 1 and PRN 2 must always be set identically.

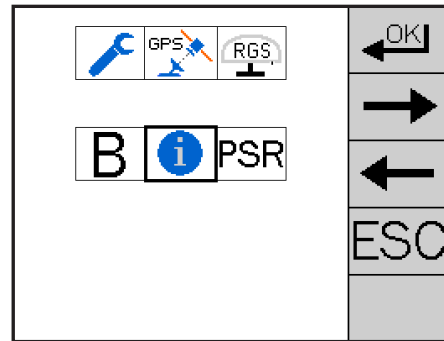

Picture 50:
 Selecting general RGS receiver settings

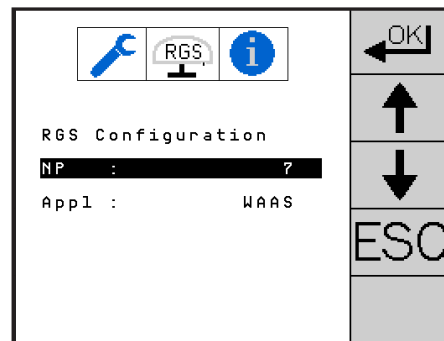

Picture 51:
 General RGS receiver settings

GPS receiver type

Here you can choose from among 3 protocol types depending on the GPS interface on the vehicle.

Choose **Typ** and confirm the selection.

➔ **Advice!** **Typ** is only available if the current type is **RS 232**. Otherwise the menu directly jumps to “Set type” (Picture 53).

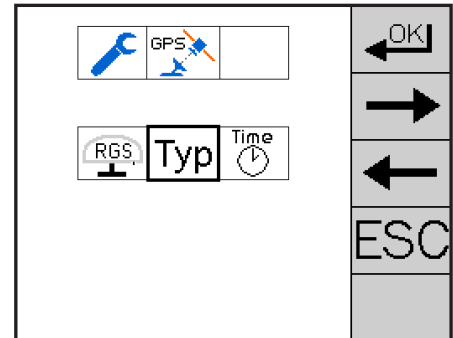

Picture 52:
 Select type

Press the function keys **→**, **←** to select the desired type.

The protocol **RS 232** is a serial interface. GPS messages are evaluated which are received in the format NMEA_0183.

➔ **Advice!** It is recommended to use the following settings:

- RMC = 10 Hz, GGA = 1 Hz
- or
- GGA = 5 Hz, VTG = 5 Hz

Protocols **NMEA 2000** and **J 1939** are standard CAN BUS protocols. One of these protocols is supported depending on the GPS receiver used; please refer to the manual of the respective GPS receiver:

- | | |
|--------------|--------------------------------------|
| J
1939 | VDS and VP each 5-10 Hz |
| NMEA
2000 | PRU and CSRU each 10 Hz, GNSS - 1 Hz |

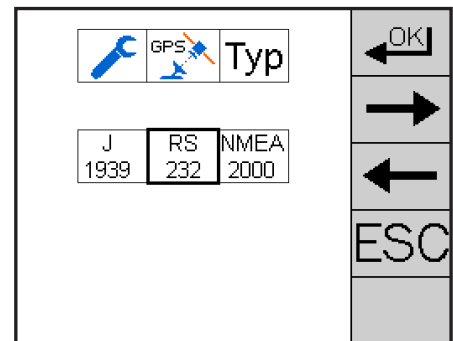

Picture 53:
 Set type

GPS after-run time

The set GPS after-run time determines how long the GPS receiver is supplied with power during a pause.



Advice! Processing can be continued quickly after short pauses.



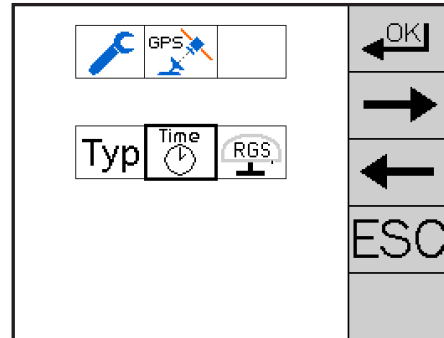

Attention! During a pause, the GPS receiver should always have an unobstructed view of the sky.

Choose  and confirm the selection.



Picture 54:
 Selecting Time

Press the function keys   to set the desired after-run time. Alternatively, you can also set the value manually as described in chapter 4.11.

Press and hold the function key  until the stored symbol appears. Proceed as described in chapter 4.12.

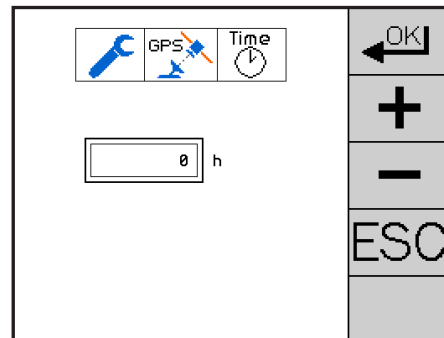

Picture 55:
 Setting the time

4.9.5. Teach-In Menu

Choose  and confirm the selection.

In the teach-in menu, you can set the desired speed sensor and tilt sensor. In addition, you can switch the TRACK-LEADER TOP mask on and off.

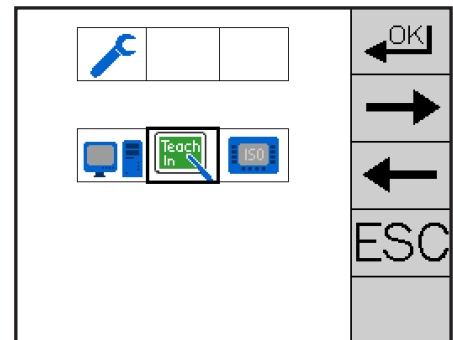

Picture 56:
 Selecting Teach-In

Setting the vehicle speed

A speed is required for Ultra Guidance PSR to take over automatic steering. The vehicle steers from a speed of 0.25 mph. The speed can be detected in three ways:

- GPS receiver
- Speed pulses from the vehicle/radar sensor
- ISO bus 11783

Choose  and confirm the selection.

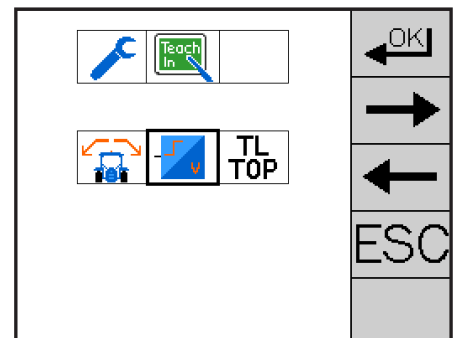

Picture 57:
 Selecting vehicle speed

Selection of speed sensors





Advice! Depending on the current speed sensor, one of the adjacent images will appear.

The speed type is used to set which signal should be used to detect the current speed.

If the speed is currently detected by the vehicle/radar sensor, select  and confirm the selection.

If the current speed is being detected by the GPS receiver or ISO bus 11783, the menu will switch directly to the selection menu for the speed signals.

Press the function keys   to set the speed type.

Press and hold the function key  until the stored symbol appears. Proceed as described in chapter 4.12.

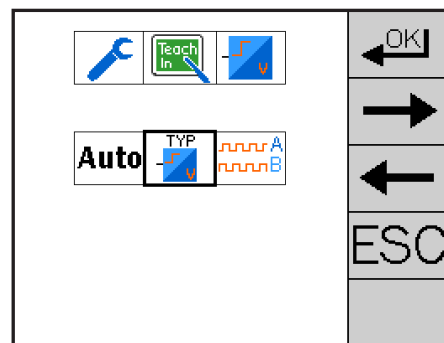

Picture 58:
 Selecting the menu

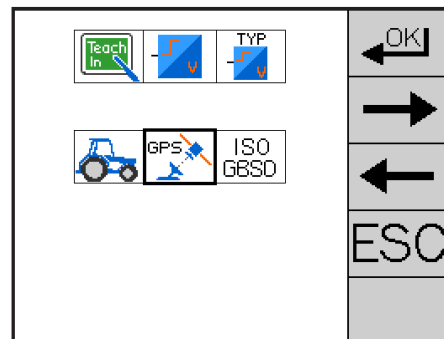

Picture 59:
 Selecting vehicle speed

The following speed sensors are available for selection:



GPS: Speed signal from GPS receiver.



ISO GBSD: ISO BUS 11783 message. Ground Based Speed. This speed is measured on the ground. The speed could be detected by radar sensor, for example.



ISO WBSD: ISO BUS 11783 message. Wheel Based Speed. This speed corresponds to the speed at wheel including slip.



Incremental sensor: Speed pulses from the vehicle/radar sensor.

If the current speed is being detected by the GPS receiver or ISO bus 11783, the menu will switch directly to the selection menu for the speed signals.

Using an incremental sensor

Choose  and confirm the selection.

Press and hold the function key  until the stored symbol appears. Proceed as described in chapter 4.12.

After confirming the selection, the following menus are available for selection:



Speed sensor type: Selection of speed sensors.



Incremental: For setting the speed pulses manually.



Auto: For setting the speed pulses automatically.

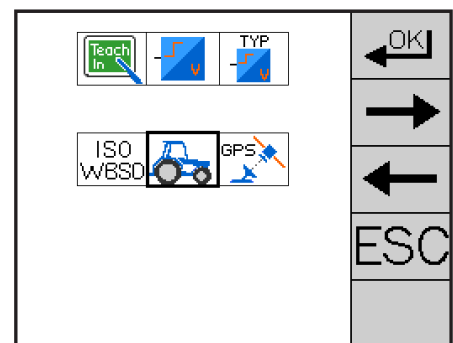

Picture 60:
 Setting the incremental sensor

➔ **Advice!** If the speed signal from the vehicle/radar sensor is used, the increments must also be set.

If the current speed is being detected by the GPS receiver or ISO bus 11783, the menu will switch directly to the selection menu for the speed signals.

Automatic speed calibration

In order to calibrate the speed between the tractor meter and ULTRA GUIDANCE PSR ISO automatically, a distance of exactly 328 ft must be driven.

Choose **Auto** and confirm the selection.

Choose **Start** and confirm the selection.

Now drive for a distance of exactly 328 ft.

Choose **Stop** and confirm the selection. Proceed as described in chapter 4.12.

➔ **Advice!** Check the taught speed calibration in the menu “Manual entry of speed increments” and correct the speed calibration if necessary.

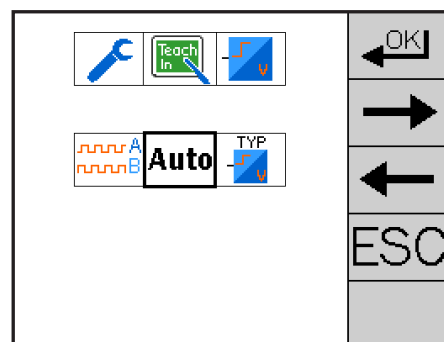

Picture 61: Calibrating speed automatically

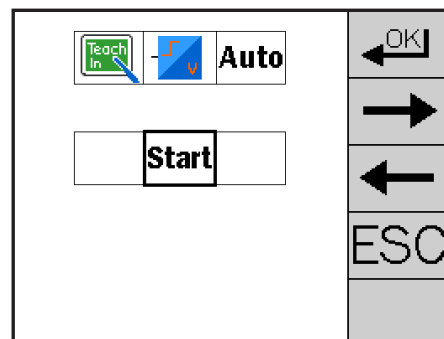

Picture 62: Automatic speed Start

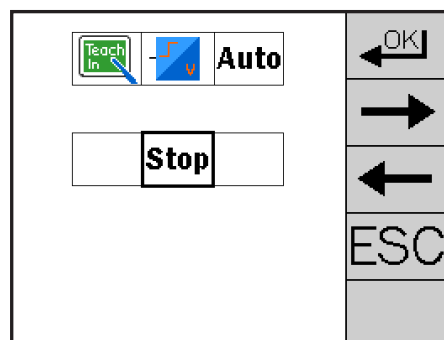

Picture 63: Automatic speed Stop

Entering the speed manually

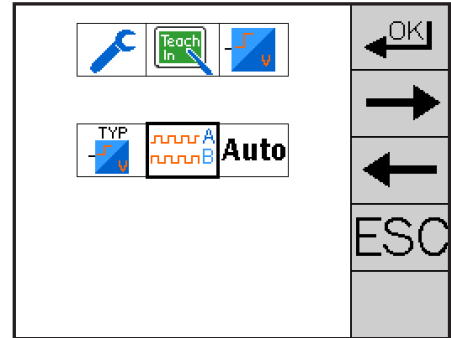

Here you can set the speed between the tractor meter and ULTRA GUIDANCE PSR ISO manually.

Choose  and confirm the selection.



Picture 64:
 Manual speed selection

Now you can set the differential speed between the ULTRA GUIDANCE PSR ISO and the tractor meter so that they agree with each other.

Press the function keys   to set the speed pulses. Alternatively, you can also set the values manually as described in chapter 4.11.

 **Advice!** To check the set increments, drive the vehicle keeping your speed as closely as possible to 3 mph. Compare the driving speed of the vehicle with the speed indicated on the display.

If the speed indicated on the display is too high, increase the speed increments.

If the speed indicated on the display is too low, decrease the speed increments.

Check the different driving speeds.

Press and hold the function key  until the stored symbol appears. Proceed as described in chapter 4.12.

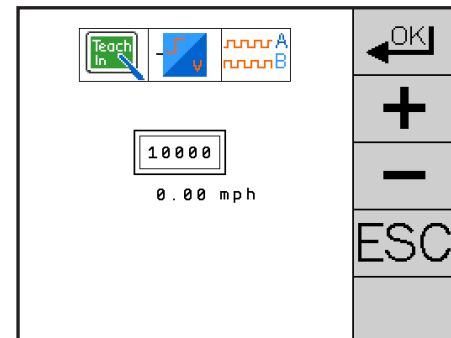

Picture 65:
 Setting the speed manually

Switching TRACK-LEADER TOP on/off

TRACK-LEADER TOP allows you to expand the functional scope of ULTRA GUIDANCE PSR ISO. Please refer to the Reichhardt PSR ISO TOP operating manual for more information.

Choose **TL TOP** and confirm the selection.

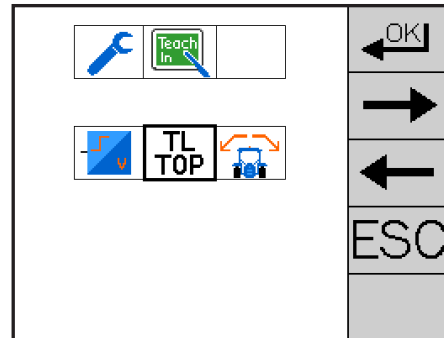

Picture 66:
 Selecting TRACK-LEADER TOP

Choose **ON**, **OFF** to switch the TRACK-LEADER TOP on or off.

ON = switch TRACK-LEADER TOP on.

OFF = switch TRACK-LEADER TOP off.

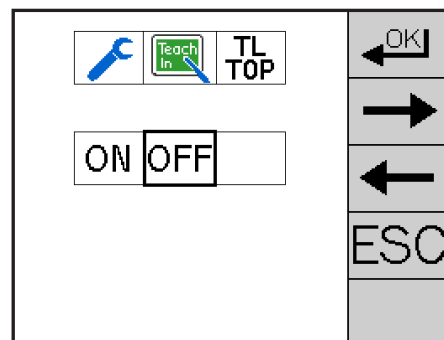

Picture 67:
 Switching TRACK-LEADER TOP off

Press and hold the function key **OK** until the stored symbol appears. Proceed as described in chapter 4.12.

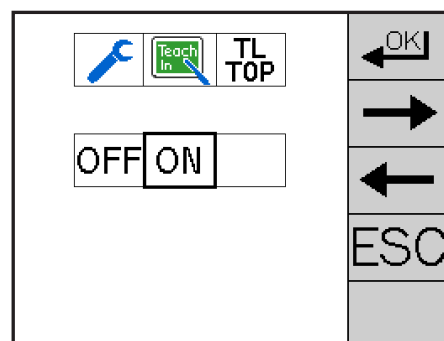

Picture 68:
 Switching TRACK-LEADER TOP on

Setting the tilt sensor

This menu item is for switching the tilt sensor on/off and for calibrating the tilt sensor.

Choose  and confirm the selection.

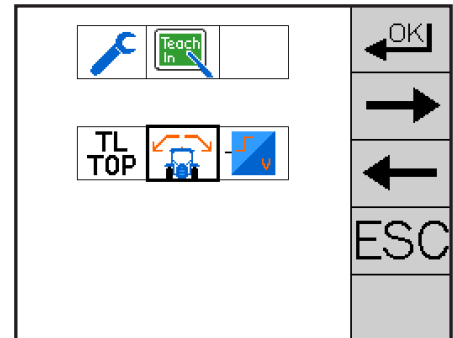

Picture 69:
 Selecting the tilt sensor

Switching the tilt sensor on/off

Select **ON** | **OFF** to switch the tilt sensor on/off.

ON = switch tilt sensor on.

OFF = switch tilt sensor off.

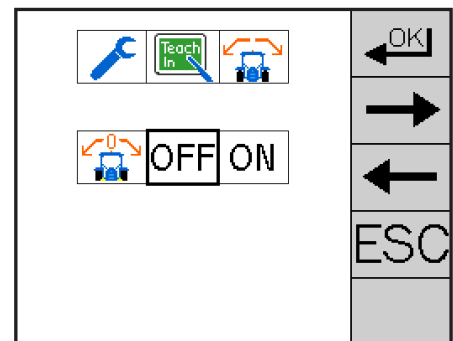

Picture 70:
 Switching the tilt sensor off

Press and hold the function key  until the stored symbol appears. Proceed as described in chapter 4.12.

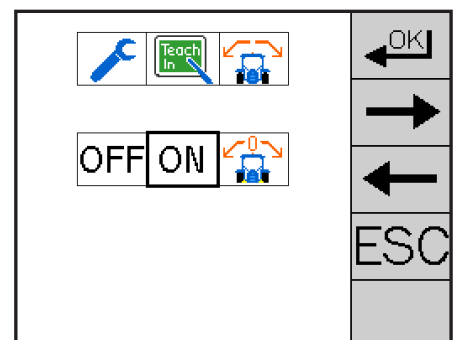

Picture 71:
 Switching the tilt sensor on

Calibrating the tilt sensor

When using a tilt sensor, its zero position must be calibrated.

Choose  and confirm the selection.

 **Advice!** Calibrate the vehicle on an even surface to obtain the most precise possible results.

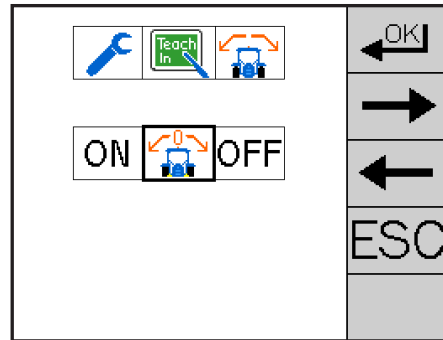

Picture 72:
 Selecting Calibrate tilt sensor

A flashing "1" will now appear on the display. Select the wheel position on the ground. Confirm this position by pressing the function key .

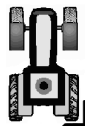

Turn the vehicle by 180° and place the wheels exactly on the previously selected wheel positions.



A flashing "2" will now appear on the display. Confirm this position by pressing the function key . Proceed as described in chapter 4.12.

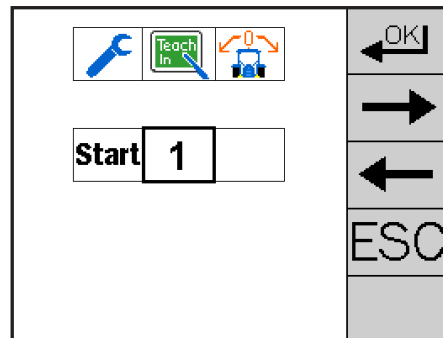

Picture 73:
 Calibrating position 1

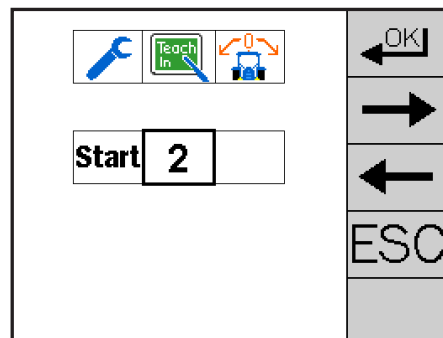

Picture 74:
 Calibrating position 2

4.9.6. Diagnostic

The diagnostic program gives an overview of the current conditions of the system. It also can help identify malfunctions.



Advice! To avoid problems with electric connections, be advised to check all input for proper function after switching between vehicles.

Choose  and confirm the selection.

On the screen, the upper line shows the sensor **A**. The lower line displays the corresponding values.

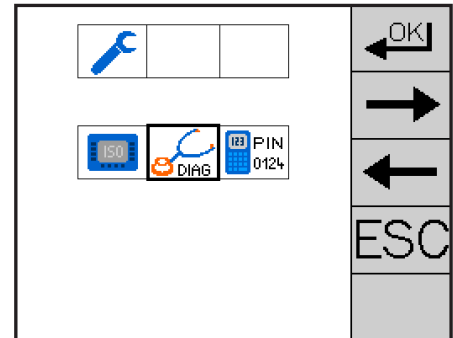

Picture 75:
 Selecting Diagnostic

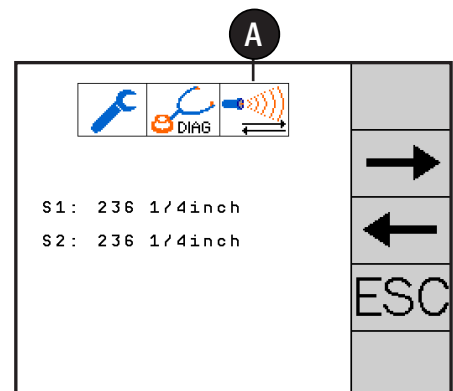

Picture 76:
 Diagnostic menu

CHAPTER OPERATION



Ultra sound: When these are connected via the front coupler, it shows the distances of the sensors to the selected measuring object. If a value of 59 inches shows, the sensor is not connected, wrongly adjusted or defective.



Gyroscope: When traveling left the value lowers, when traveling right the value increases. During stand still it should show about 500, and when standing still the value should not fluctuate.

-42,97 = rotation to left 20,03 = rotation to right



Tilt sensor: In a parked vehicle, sitting level, the value should be about 450. A slight tilt to the left the value drops, a slight tilt to the right and the value increases.

-0,023 = tilt to left 1,025= tilt to right



Mechanical row finder: Displays the actual position of the receiver tool. When moving the receiver tool, the value increases or decreases accordingly.



TAC-Sensor: The display shows the actual values of the sensors (S1/S2 and/or S3/S4 depending configuration). When the paddle is at rest, a value of 50 should show. While moving the sensor, the value increases and should not exceed 500.

Contact an authorized dealer if values under 40 or over 500 are showing, or if nothing changes when moving the wand.



Wheel angle sensor: It shows the current angle relative to the axle. If the angle changes with the help of the steering wheel, the value either increases or decreases accordingly.



Danger! Faulty signal reception could be life threatening. If, when moving the steering wheel, the steering axle moves, but the displayed value does not change, the automatic steering system must be stopped immediately. Call authorized service and make sure, that the vehicle will not be used with automatic steering until authorized service clears it for such operation mode again.



Safety Switch: The screen shows the status of the safety switch. When opening the cab door or activating the seat contact switch the value changes from 0 to 1 or vice versa.



Speed: The actual vehicle speed is shown.



Pressure sensor: The value shown should change when turning the steering wheel. During stand still the value should be between 165 and 200.



RDU impulse counter of the steering motor: If the friction wheel is turned manually, both values should change with rotation.



Foot Switch: "0" = Switch not activated; "1" = switch activated.



GPS: In several menus the actual values of the GPS receiver are shown.

- The values for Lon. / Lat. are the coordinates of the GPS receiver. They should constantly change when in motion. In a parked vehicle only small variations should be seen after the third decimal. Stronger variations suggest of considerable satellite drift when parked.
- Quality: Signal quality of the GPS receiver.
- Date and time correspond not to the actual local time but GPS-Time.
- Heading: Shows the driven compass angle.
- Sat: Number of currently received satellites.
- HDOP: Accuracy of the position. The higher the value the worse the positioning.
- Reference-ID: ID of the reference signal used.
- Display of current updates.
- Display of update data of the messages displayed by the GPS receiver.



The actual hours and miles driven with automatic steering are displayed. The value shown under Code is required when asking about service questions.



Display of the steering mode.



In several menus various values like voltage, Baud rate and CPU-load, as well as failure state for the CPU are seen.



4.9.7. System Information

The information menu answers questions about the software version and the serial number of the PSR ISO mask and the PSR iBox. Information about a dealer or service partner is also shown.

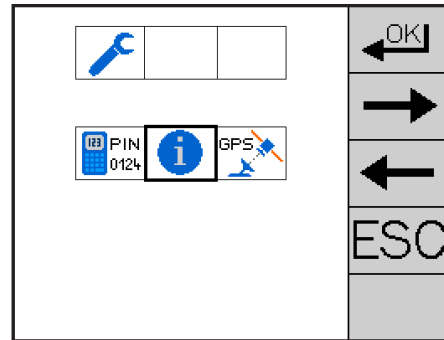
Choose  and confirm the selection.



Picture 77:
 System information

Press the function keys   to find the next information page.

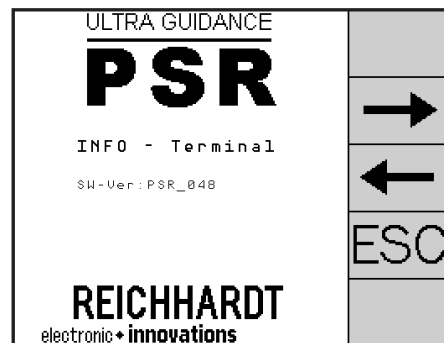

Picture 78:
 Information page PSR ISO mask

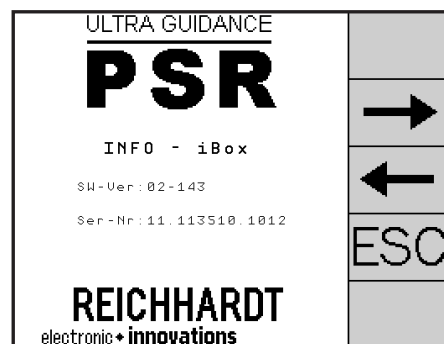

Picture 79:
 Information page PSR iBox



Advice! Have this information on hand when contacting customer service.

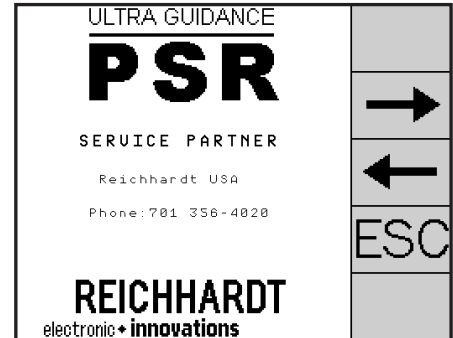

Picture 80:
 Information page customer service

4.9.8. Service menu

Choose  and confirm the selection.

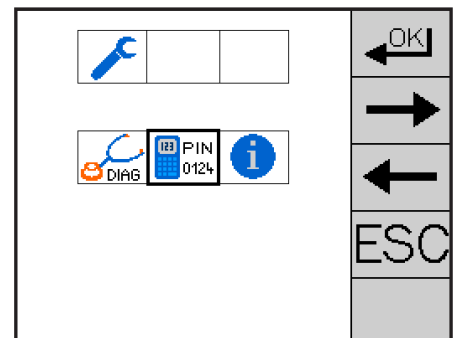

Picture 81:
 Service Menu



Attention! For safety reasons access is only provided to authorized service personnel.

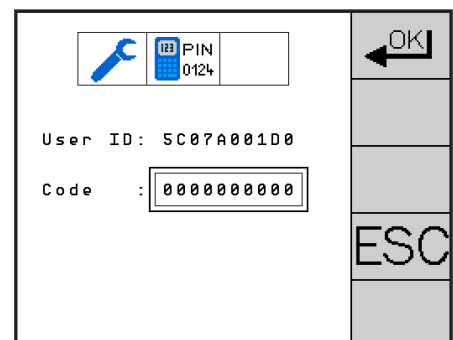

Picture 82:
 Enter - PIN

4.9.9. Calculator

In the menu Calculator, you can execute numerical calculations.

Choose  and confirm the selection.

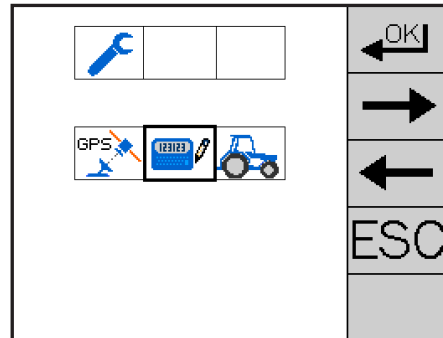

Picture 83:
 Select Calculator

The result is displayed by pressing the button .

The current entry is cancelled by pressing the button .

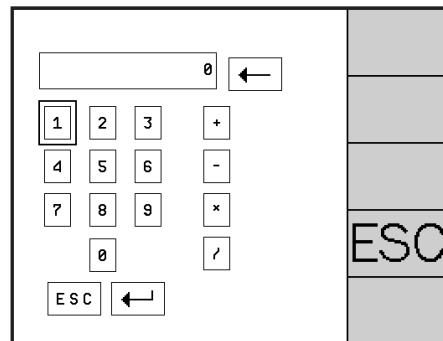



Picture 84:
 Calculation

 **Advice!** Press the function key  to return to the main menu.

4.10. Setting parameters – Adjusting values



The menu Set parameters is used to adjust or reset all the required parameters.

➔ **Advice!** The function key  can be used at any time to cancel all changes and to leave the menu.

➔ **Advice!** The function key  only appears when you have made an entry. The data is accepted when you press this function key. Proceed as described in chapter 4.12.

Parameter selection

Each parameter is designated by a number.

- Press the function keys   until the desired parameter is shown.
- These values are directly taken over by selecting Def - Min - Max. Alternatively, you can also set the value manually as described in chapter 4.11.

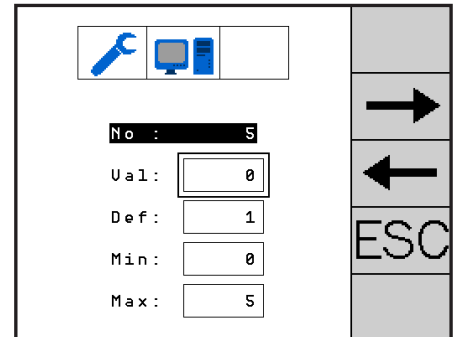

Picture 85:
 Setting the values

No	Parameter
Def	Default value
Val	Set value
Min	Minimum value
Max	Maximum value

Table 1:
 Abbreviations in the screen display

4.10.1. Acceptance of values

- Acceptance of default value

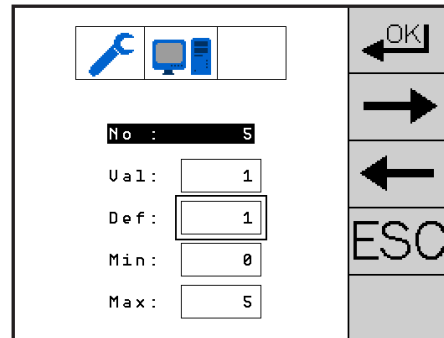

Picture 86:
Accept Def.

- Acceptance of minimum value

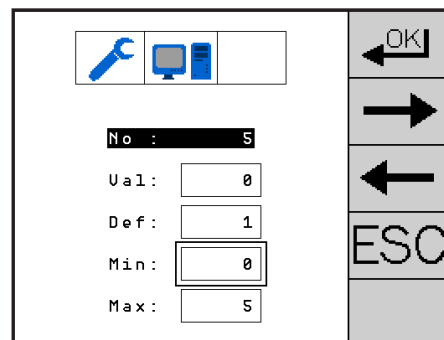

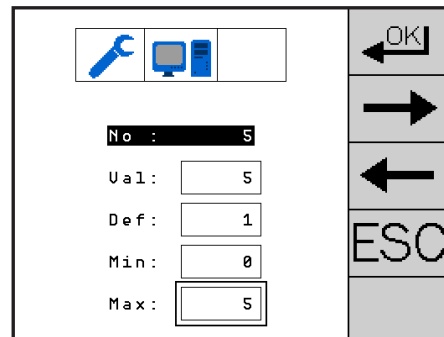

Picture 87:
Accept Min.

- Acceptance of maximum value



Picture 88:
Accept Max.

4.11. Numerical entry

Min and Max define the possible range of values. Enter the desired value and confirm by pressing  or the function key .

 **Advice!** Please refer to the user manual of the ISOBUS terminal for how to use and enter digits.

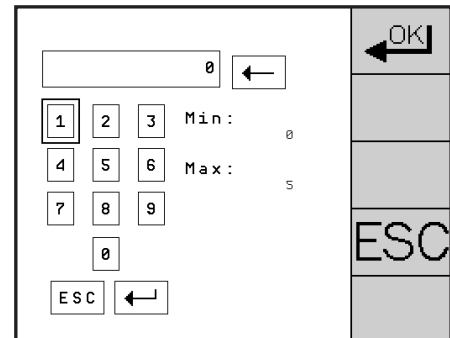

Picture 89:
 Setting a value

4.12. Saving changes

After you make settings, you will be prompted to indicate whether you want to save your changes or not.

Select  and confirm the selection to save the changes.

Select  and confirm the selection to discard the changes.

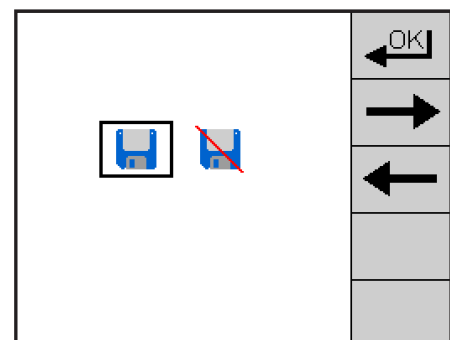

Picture 90:
 Save changes

5. PSR SKY

5.1. GPS mode overview

A-B mode

In the A-B mode a reference line is determined by manually setting two points in the field (see adjacent figure).

Vehicle steering then follows automatically parallel to the reference line. The system is capable to store up to 200 different reference lines (A-B lines).

➔ **Advice!** Even if the vehicle does not drive the minimum distance between A and B, the system will calculate and store the shortest distance.

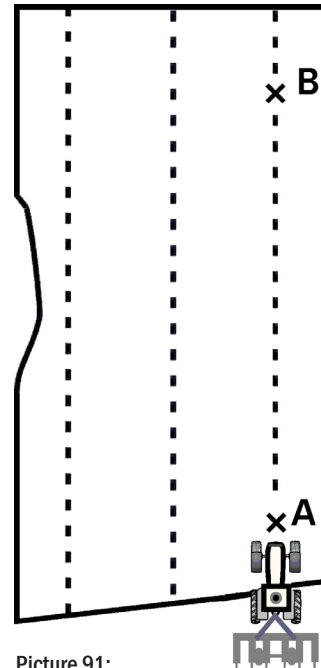

Picture 91:
A-B line

In the A-B mode, the reference line is determined by manually setting the beginning point and indicating the compass direction.

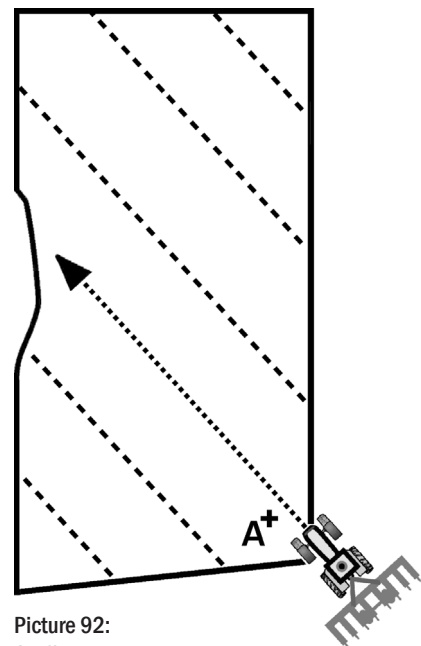

Picture 92:
A+ line

Multi-line

The GPS-Mode Multi-line can join up to 10 A-B lines into one job. This would be suitable for working fields around the perimeter as in the adjacent figure (e.g. harvesting with a combine harvester).

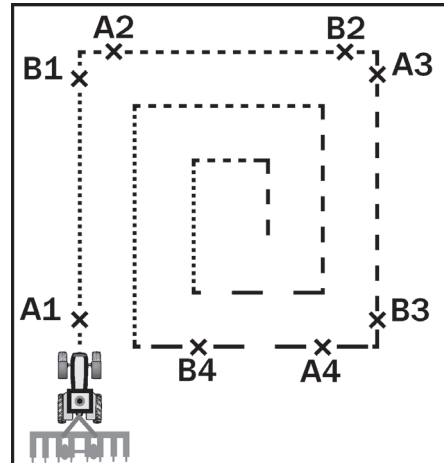

Picture 93:
Multi-line

Circles

In the GPS mode Circle, a center is set. The vehicle is driven in circles around this center at the distance of the working width. This GPS mode is suitable for working fields e.g. around circular irrigation lines.

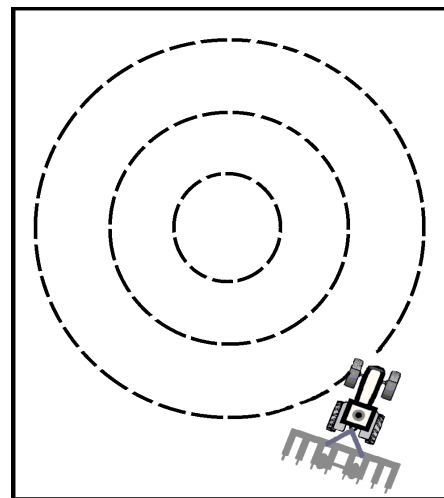

Picture 94:
Circle

5.2. Menu structure PSR SKY

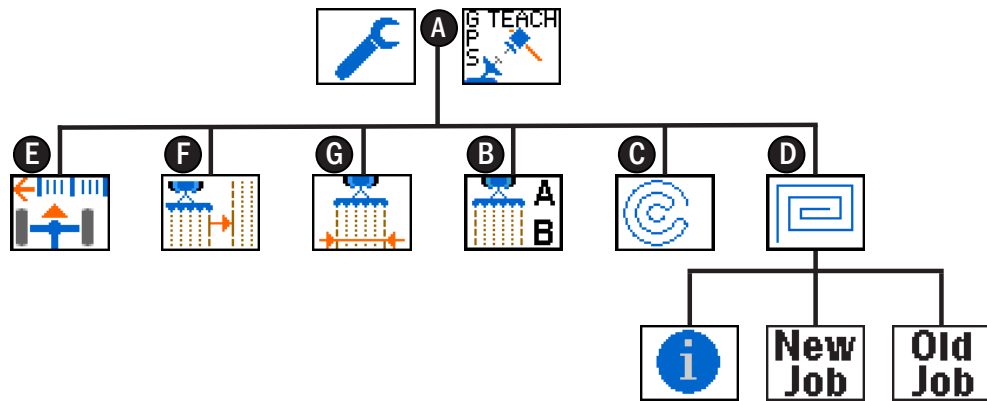

Picture 95:
 Menu structure PSR SKY

- Ⓐ = Main menu PSR-SKY
- Ⓑ = A-B line
- Ⓒ = Circles
- Ⓓ = Multi-line
- Ⓔ = Nudging setting
- Ⓕ = Implement offset setting
- Ⓖ = Working width setting



Advice! As long as the automatic steering is activated, only menu **F** Implement Offset is available.

5.2.1. Main screen PSR SKY

Display: Main screen

Here you can set the drive mode PSR SKY as in the adjacent picture (see chapter 4.5.).

Unique features of the drive mode PSR SKY:

A variety of information is available in PSR SKY drive mode.

Press  to switch to the additional information.

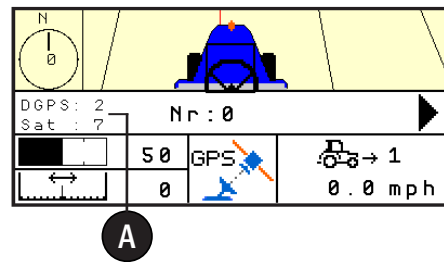

Picture 96:
Main screen PSR SKY

GPS Status

In the display field **A**, the operator can observe the quality of the GPS signal. The display of “2” indicates that a DGPS signal has been acquired. The following table gives an overview of GPS signal quality.

The second number Sat tells how many satellites are being received and utilized.

Quality	
0	INV
1	GPS
2	DGPS
4	RTK fix
5	RTKF

Table 2:
GPS status table

 **Advice!** If the display shows the quality “float” it is recommended to wait until the quality changes to “fix”. If fewer than 4 satellites are received GPS driving is not possible.

GPS mode

The display field **B** shows the selected job.
The second line indicates how the selected job was designated.

 **Advice!** In “Multi-line” drive mode, the name is preassigned by the system.

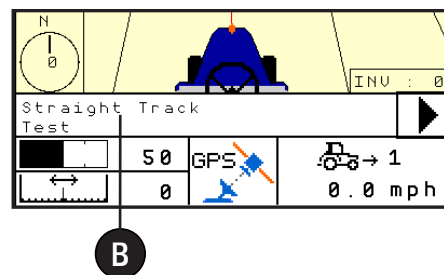

Picture 97:
Main screen PSR SKY

Direction/Working width

The display field **C** shows the target direction in which you are working.

The second line, “W-width”, indicates the working width currently set in the system.

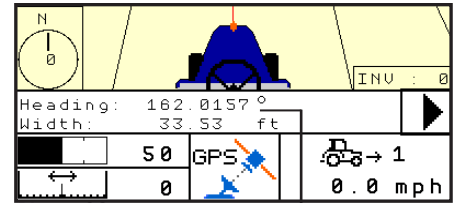

Picture 98:
Main screen PSR SKY

Reception strength

The display field **D** shows the GSM reception strength. The adjacent table shows an overview of the available reception strength.

➔ **Advice!** GSM reception is only available if you installed an RTK CLUE-Modem.

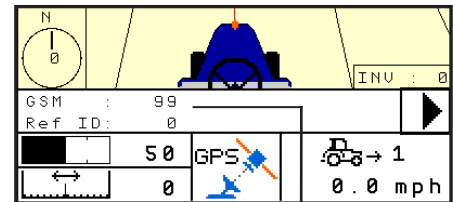

Picture 99:
Main screen PSR SKY

Reception	
99	No reception
0-10	Weak reception
32	Full reception

Table 3:
GSM reception strength

The second line indicates the base station from which the correction signal is received.

Work Data

In this display field, all important data relating to the actual GPS job is shown.

In the display field **E** the deviation from the current guide line is given in inch. The deviation is additionally displayed as arrows. The direction of the arrow represents the required steering correction.

The track counter **F** shows the current track number where the vehicle is located. Track # 0 is the established reference line. Tracks to the right are positive and tracks to the left are negative. The possible max number would be -9999 to + 9999.

➔ **Advice!** In the drive mode PSR SKY is a deviation distance left or right from the reference line indicated. It means that all following passes are being pushed left or right.

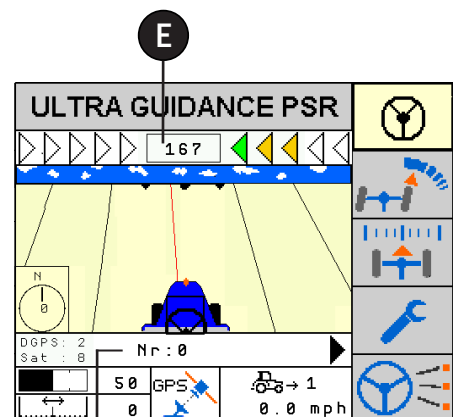

Picture 100:
Main screen PSR SKY

5.2.2. Main menu PSR-SKY

Display: Main screen

Tap the function key  to change the main menu PSR SKY.

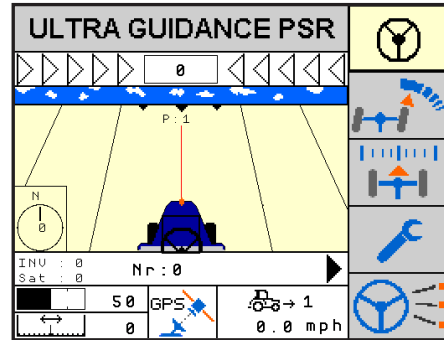

Picture 101:
 Main screen PSR SKY

5.3. A-B line

Choose  and confirm the selection.

 **Advice!** This function is only available as long as the automatic steering is deactivated.

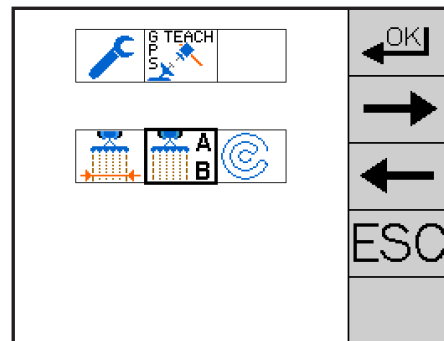

Picture 102:
 Select A-B line

5.3.1. Setting a straight A-B line

A - Field

Press “Field” to select a field which has been previously created and stored.

B - New

Press “New” to create a new field.

C - Delete

Press “Delete” to delete the currently selected field.

D - Method

Press “Method” to specify how the A-B line should be created. The following selections are available:

- A + B = set points A and B.

Select the button “W-width” to set your working width.

Use the button “Set A” to set point A of your A-B line and “Set B” to set point B of your A-B line.

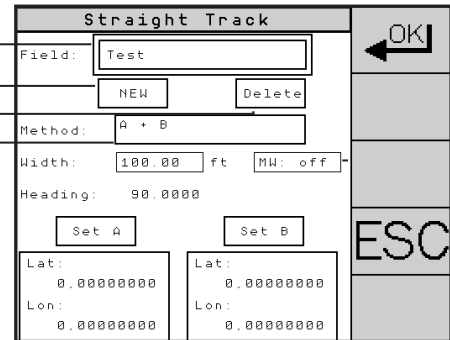

Picture 103:
 Select New Job

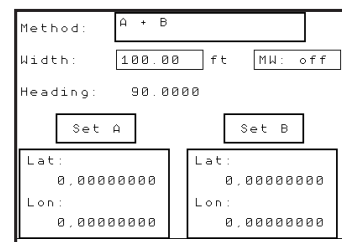

Picture 104:
 New job (A-B line)

- A + Heading = set point A, enter compass direction.

Select the button “W-width” to set your working width.

In the “Heading” display, select the exact compass direction in which you wish to drive. As an alternative, you can specify the compass direction by homing in on a certain point and driving towards it. Confirm the selection as soon as the heading is correct.

Use the button “Set A” to set point A.

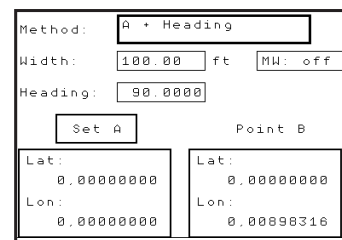

Picture 105:
 New job (A + Heading)

- Lat/Lon = entry of coordinates of points A and B.

Select the button “W-width” to set your working width.

Select buttons “Point A” and “Point B” to enter the current coordinates.

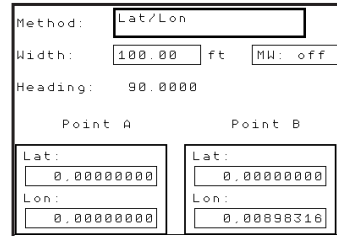

Picture 106:
 New job (Lat/Lon)

- Lat/Lon + Heading = entry of coordinates of points A and B, entry of compass direction

Select the button “W-width” to set your working width.

In the “Heading” display, select the exact compass direction in which you wish to drive. As an alternative, you can specify the compass direction by homing in on a certain point and driving towards it. Confirm the selection as soon as the heading is correct.

Select button “Point A” to enter the current coordinates.

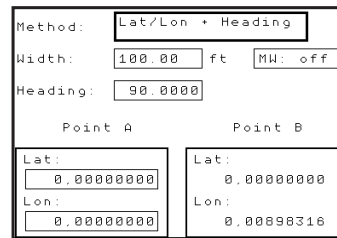

Picture 107:
 New job (Lat/Lon + Heading)



Advice! It is recommended to use two corners of the field as A and B points. The larger the distance between the two marker points the more exact the reference line. A distance between points A and B which is less than 60 ft is not acceptable to the system.



Advice! We recommend using “A + Heading” and “Lat/Lon + Heading” only when the exact compass direction is known.

In this system the compass direction of the reference line is also stored with each job.

Stop the vehicle when you want to readjust the heading in which you wish to drive.



Advice! The Set W-width function is only possible if “AT” (asynchronous tracks) is switched off.

5.3.2. Asynchronous tracks

With different working widths, you can drive the field in the pattern of the track entered (e.g. 10 rows of onion bed tracks and a working width of 20 ft + 1 maintenance track for irrigation and a working width of 10 ft). We refer here to asynchronous tracks.

Select the “AT” button and make settings for asynchronous tracks.

The following selections are available in the Asynchronous Tracks area.

Area **A** “Seed rows”:

- W-width = Working width of the seed rows.
- Number of tracks = entry of tracks to be driven

Area **B** “Tram path”

- W-width = Working width of the tram path.
- Number of tracks = entry of tracks to be driven

Area **C** “Type of AB track 0”

- Type of track = with which type (seed rows or tram path) the “asynchronous tracks” should begin.

The seed rows is used e.g. when you want to harvest a track with seeds.

The tram path is used e.g. when you wish to use a track as a tramline.

- Track # = with which track the selected seed rows/tram path is to begin.
- Active = “AT” on/off.

Confirm this entry by pressing the function key



Advice! All current coordinates (Set A + Set B) with respect to the current A-B line are accepted in the area **C**.

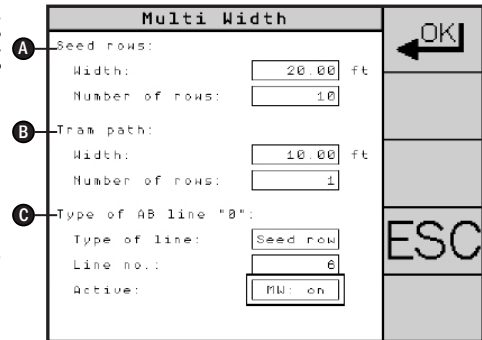

Picture 108:
 Asynchronous tracks

Example 1 of asynchronous tracks:

If you have created three seed rows (B) with a working width of 16 ft and two tram path (P) with a working width of 26 ft and would like to begin with track 3 B, you have to make the following settings:

Seed rows:

- W-width: 16 ft
- Number of tracks: 3

Tram path:

- W-width: 26 ft
- Number of tracks: 2

Type of AB track "0":

- Type of track: Seed rows
- Track #: 3
- Active: AT: on

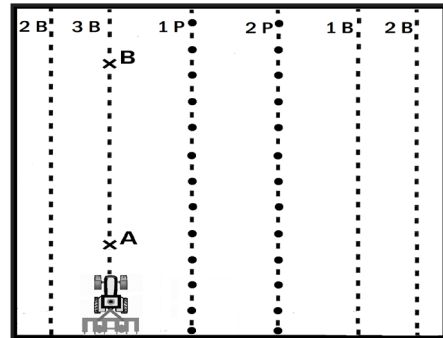

Picture 109:
Asynchronous tracks

Multi Width		OK
Seed rows:		←
Width:	16.00 ft	
Number of rows:	3	
Tram path:		
Width:	26.00 ft	
Number of rows:	3	
Type of AB line "0":		ESC
Type of line:	Seed row	
Line no.:	3	
Active:	MW: on	

Picture 110:
Asynchronous tracks

Example 2 of asynchronous tracks:

If you have created two seed rows (B) with a working width of 10 ft and four maintenance tracks (P) with a working width of 20 ft and would like to begin with track 2 P, you have to make the following settings:

Seed rows:

- W-width: 10 ft
- Number of tracks: 2

Tram path:

- W-width: 20 ft
- Number of tracks: 4

Type of AB track "0":

- Type of track: Main. track
- Track #: 2
- Active: AT: on

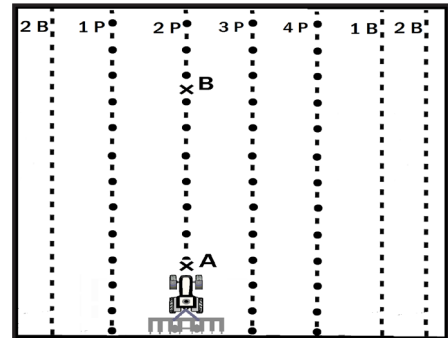

Picture 111:
Asynchronous tracks

Multi Width	
Seed rows:	
Width:	<input type="text" value="10.00"/> ft
Number of rows:	<input type="text" value="2"/>
Tram path:	
Width:	<input type="text" value="20.00"/> ft
Number of rows:	<input type="text" value="4"/>
Type of AB line "0":	
Type of line:	<input type="text" value="Tram pat"/>
Line no.:	<input type="text" value="2"/>
Active:	<input type="text" value="MH: on"/>

OK
ESC

Picture 112:
Asynchronous tracks

5.4. Drive mode Circles

Choose  and confirm the selection.

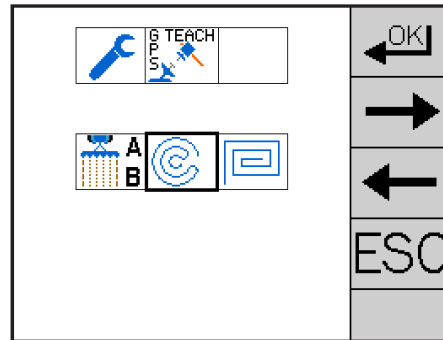

Picture 113:
 Drive mode Circles

5.4.1. Setting circles

Please refer to chapter 5.3.1. for items **A** - **C**.

D - Method

Select "Method" and specify how the circles should be created. The following selections are available:

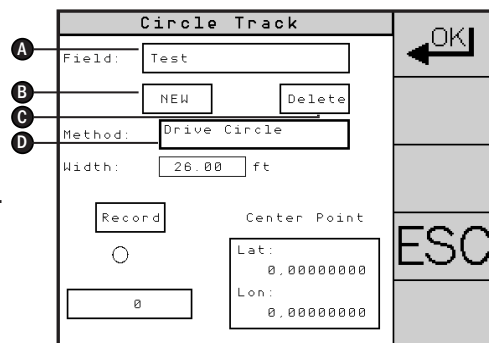

Picture 114:
 New job

- Drive in circle = By driving along a circular track, the center is defined for all the following tracks. ULTRA GUIDANCE PSR ISO automatically calculates the center of the circle after a three-quarter turn.

Select the button "Width" to set your working width.

Select "Record" and start/stop the recording. Now make a three-quarter turn. You can track the progress using the blue bar.

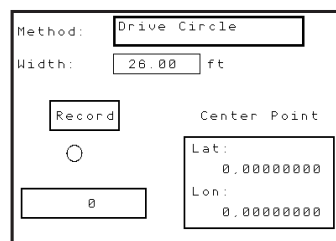

Picture 115:
 New job (Drive in circle)

- Lat/Lon = Entry of coordinates of center of circle.

Select the button “W-width” to set your working width.

Select button “Lat/Lon” to enter the current coordinates of the center of the circle.

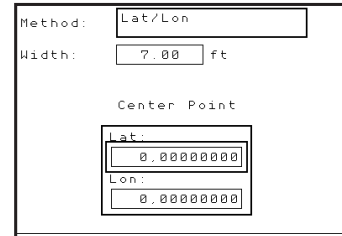

Picture 116:
New job (Lat/Lon)

- Set Center = set the center of the circle.

Select the button “W-width” to set your working width.

Select button “Set Center” to set the current coordinates of the center of the circle.

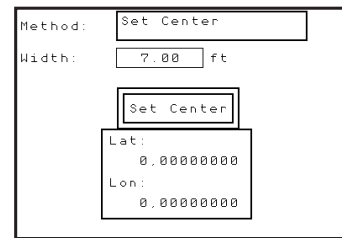

Picture 117:
New job (Set Center)

5.5. Multi-line Mode

Enter the individual reference lines in the same sequence of operation. The system does not allow for exchange of reference lines at a later time.

Choose  and confirm the selection.

 **Advice!** This function is only available as long as the automatic steering is deactivated.

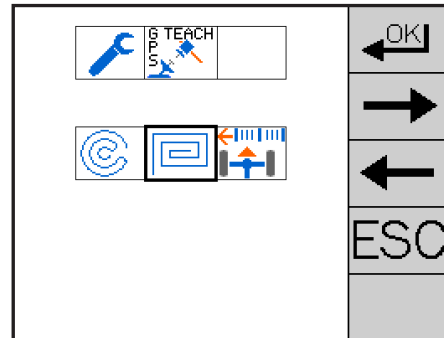

Picture 118:
 Select Multi-line mode

Recording Multi-Line in A-B Mode:

Choose  and confirm the selection.

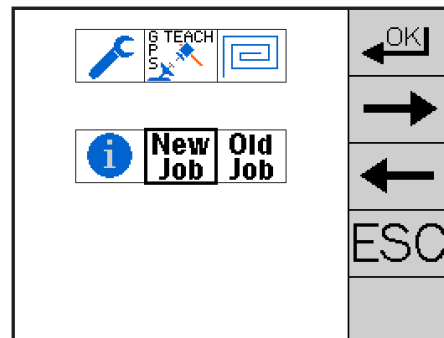

Picture 119:
 Select new Job

Choose  and confirm the selection.

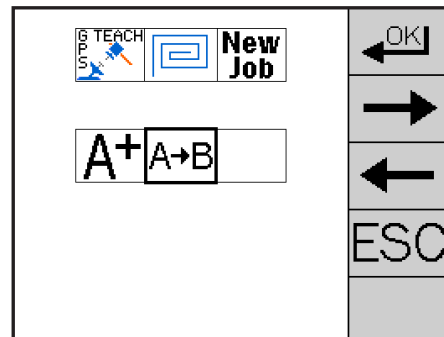

Picture 120:
 Select Job mode

An “A” in a blinking frame appears on the display. Left to this the number of the current reference line is shown in picture 121. Drive to the desired point A of your current reference line and confirm this position.

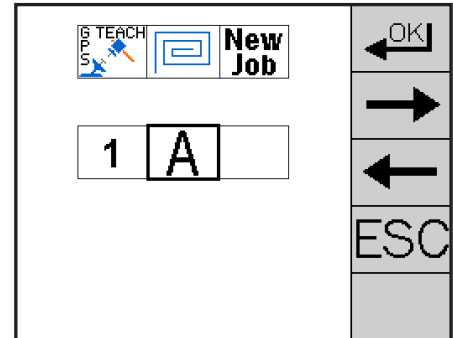

Picture 121:
 Confirm Point A

A “B” in a blinking frame appears on the display. Drive to point B and confirm this position.

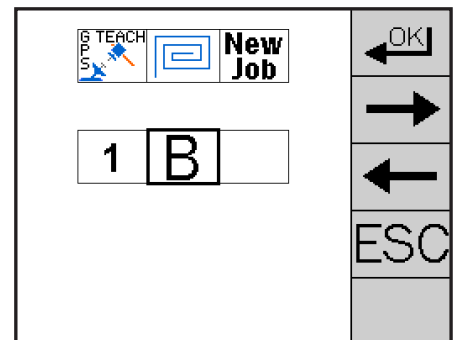

Picture 122:
 Confirm Point B

Select **Start** if you want to add an additional line.

Select **Stop** if you want to stop the multi-line.

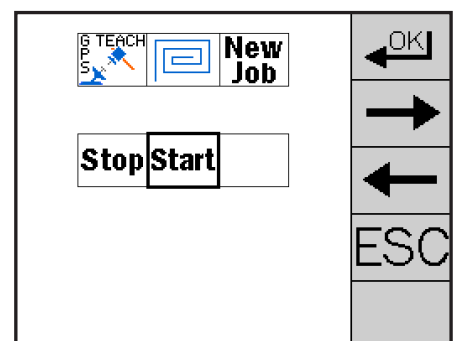

Picture 123:
 Add additional line

Start As soon as you have chosen, the next reference line will be displayed with an "A" in a blinking frame. Continue as described.

In the multi-line mode up to 10 reference lines can be stored.

After the 10th line is entered the multi-line info is automatically stored.

After storing the multi-line the main display returns.

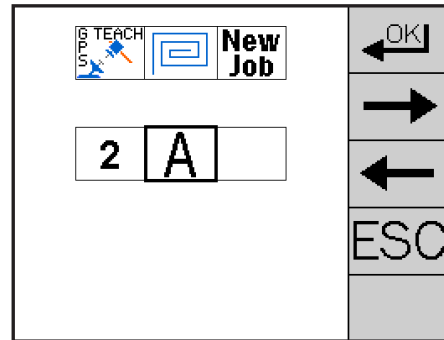

Picture 124:
 Confirm Point A

Recording Multi-Line in A+ Mode:

Choose **New Job** and confirm the selection.

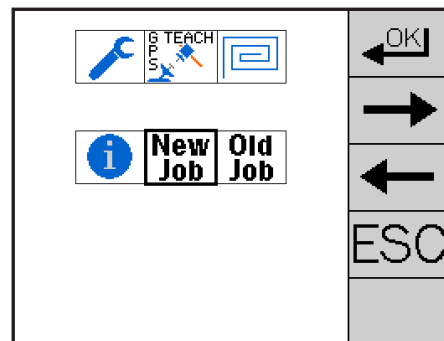

Picture 125:
 Select new Job

Choose **A+** and confirm the selection.

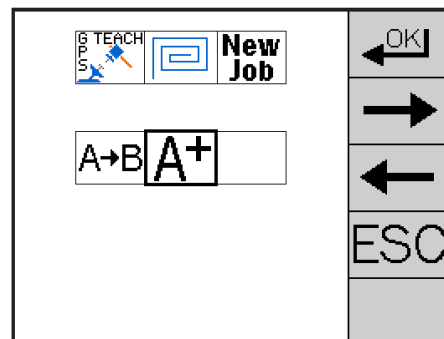

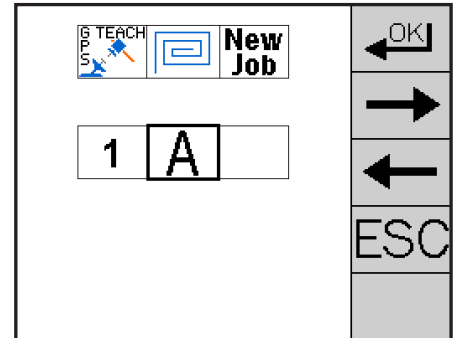

Picture 126:
 Select Job mode

An "A" in a blinking frame appears on the display. Left to this the number of the current reference line is shown in picture 127. Drive to the desired point A of your current reference line and confirm this position.





Picture 127:
 Confirm Point A

The information display shows the current driving direction. Stop the vehicle to set the compass direction manually.

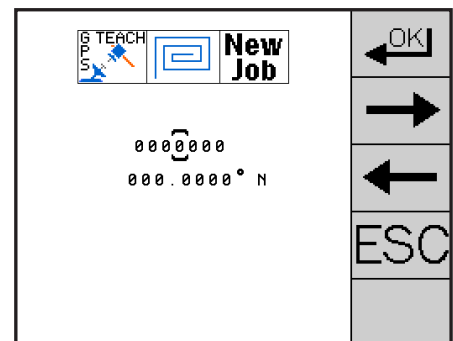
Press the function keys ,  to select the decimal place of the compass direction you want to enter.



Picture 128:
 Selecting the decimal of the compass direction

Use the buttons ,  to exactly set the compass direction.

Confirm the entry. Press and hold the function key  to save the entry. As an alternative, you can specify the compass direction by homing in on a certain point and driving towards it.

 **Advice!** Stop the vehicle when you want to readjust the direction in which you wish to drive.

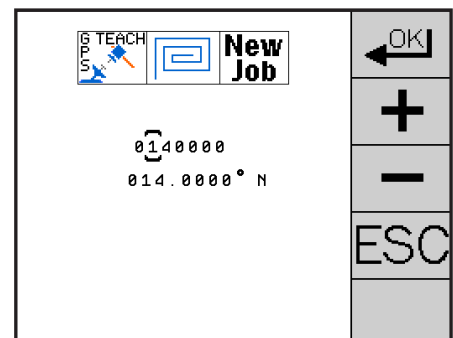

Picture 129:
 Set compass direction

Select **Start** if you want to add an additional line.

Select **Stop** if you want to stop the multi-line.

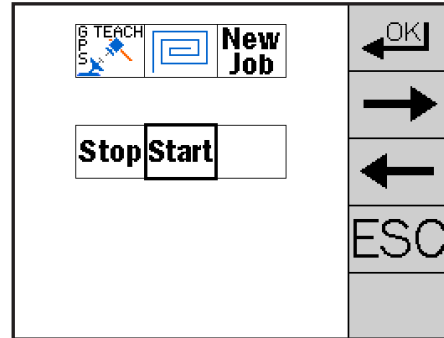

Picture 130:
 Add additional line

Start As soon as you have chosen, the next reference line will be displayed with an "A" in a blinking frame. Continue as described.

In the multi-line mode up to 10 reference lines can be stored.

➔ Advice! After the 10th line is entered the multi-line info is automatically stored.

After storing the multi-line the main display returns.

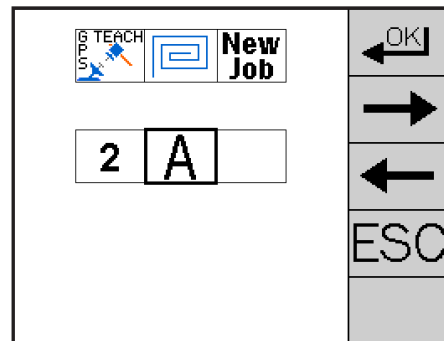

Picture 131:
 Confirm Point A

Multi-line Information

Choose  and confirm the selection.

The number in the lower display field shows the reference line with the corresponding compass direction of the multi-line.

 **Advice!** The system shows all stored reference lines in the multi-line mode.

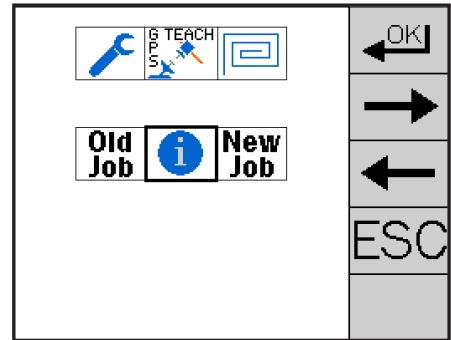

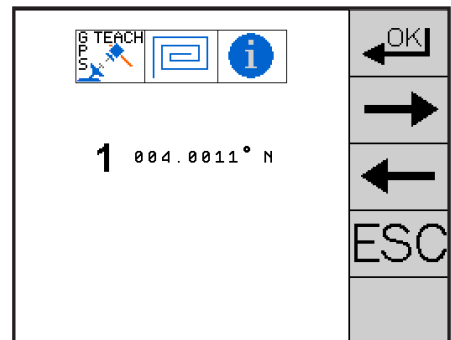

Picture 132:
 Multi-Line Information





Picture 133:
 Multi-line Information

5.6. Working with a stored mode

Choose  and confirm the selection.

Choose  and confirm the selection.

Select the desired reference line in the mode and confirm the selection.

For  or , proceed as described in the associated chapters.

 **Advice!** Check the working width set in the system, as the selected job may contain another working width.

In order to ensure the maximum working accuracy of PSR SKY, drive to the first track at which you wish to begin working and check if there is a discrepancy from the target track.

If there is a discrepancy, proceed as described in chapter 5.5.1.

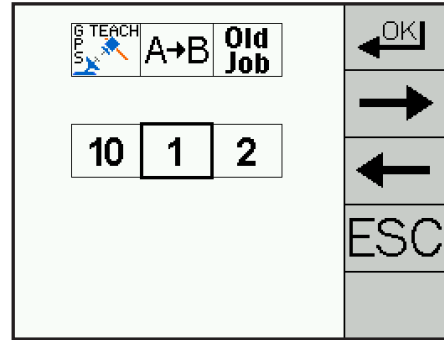



Picture 134:
 Select reference line

5.7. Set working width

The working width is required to assure a correct distance parallel the reference line.



Choose  and confirm the selection.

For  or , proceed as described in the associated chapters.

 **Advice!** This function is only available as long as the automatic steering is deactivated.

 **Advice!** When setting the working width consider a few inch overlap to avoid gaps.

This overlap depends on the quality of the GPS signal. It ranges from 1 to 4 inches with (RTK signal) or 6 to 12 inches with a (DGPS signal). It is best to determine the overlap on location with a test run.

Set the working width with the function keys  . Alternatively, you can also set the value manually as described in chapter 4.11. Working widths between 1,64 ft to 164 ft are possible.

Press and hold the function key  until the stored symbol appears. Proceed as described in chapter 4.12.

 **Advice!** Should the GPS signal weaken during a particular field operation, the working width may need re-setting. This causes all passes to be moved with the new setting.

In this case it is necessary to recalibrate the system to the reference line after each change to the working width (see chapter 5.5.1.).

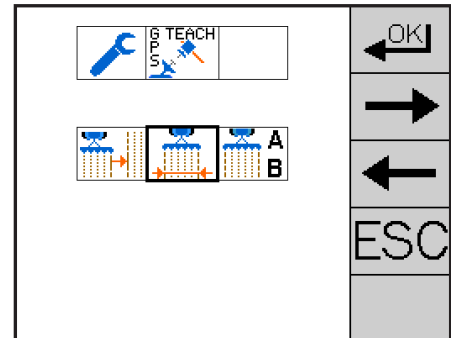

Picture 135:
 Select setting of working width

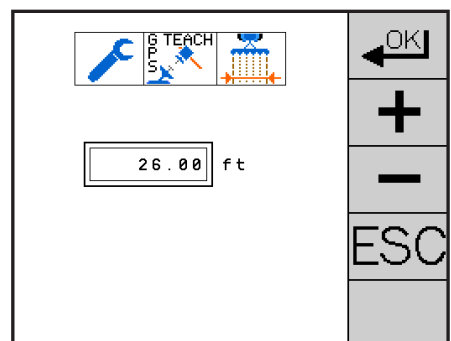

Picture 136:
 Set working width



5.8. Implement offset setting

The offset correction is needed when the implement is not centered on the steered vehicle.

Test this by driving 3 passes. The operator may notice overlap on one side, and a skip on the other side of the center pass (see adjacent figure).

To correct this offset in the steering system, measure the width of the skip.

Choose  and confirm the selection.

Press the function keys   to enter the previously measured value. Alternatively, you can also set the value manually as described in chapter 4.11.

- Offset to the right means the skip is on the left (in driving direction). Then enter the measured distance with a (-) in front.
- Offset to the left means the skip is on the right (in driving direction). Then enter the measured distance with a (+) in front.

Press and hold the function key  until the stored symbol appears. Proceed as described in chapter 4.12.

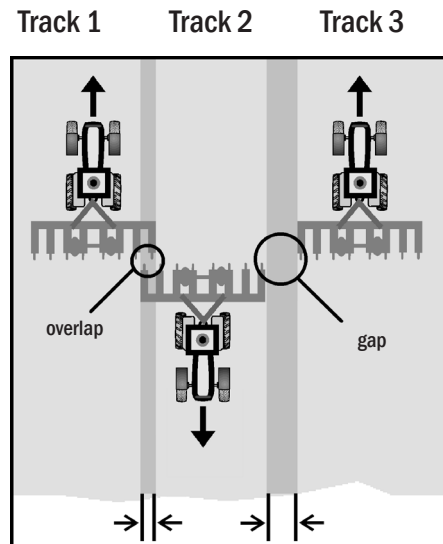

Picture 137:
 Demonstrate offset left/right

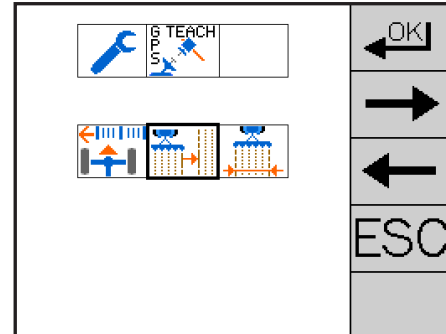

Picture 138:
 Implement offset setting

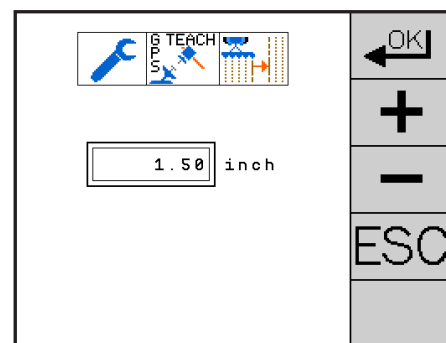



Picture 139:
 Setting offset left or right

5.9. Nudging setting

In the “Nudging setting” menu, you can set how many “inch” the distance in the main menu should be shifted with each press of the button.

 **Advice!** This setting only affects “GPS” drive mode.

Choose  and confirm the selection.

Press the function keys   sets the nudging value. Alternatively, you can also set the value manually as described in chapter 4.7.

Press and hold the function key  until the stored symbol appears. Proceed as described in chapter 4.12.

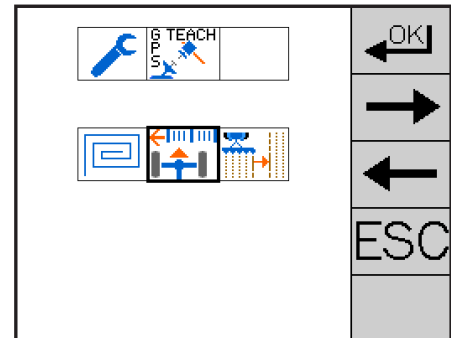

Picture 140:
 Select Nudging setting

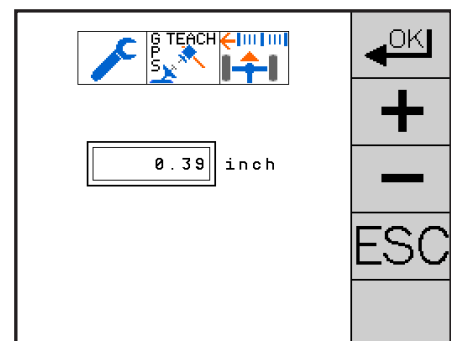

Picture 141:
 Set nudging

5.10. Working with GPS

5.10.1. Calibrating a Reference Line

Display: Main screen

Tap the function key  to change the “Calibrate reference line” menu.

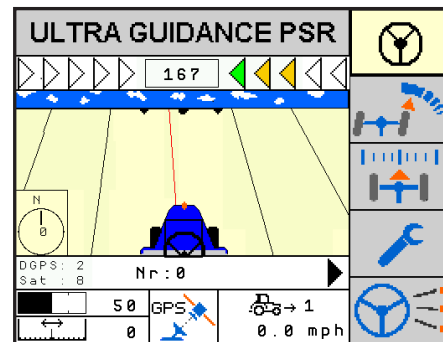

Picture 142:
 Main screen PSR SKY

Tap the function key  to set the reference line to zero.

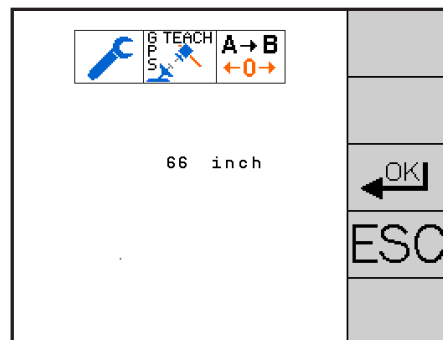

Picture 143:
 Calibrating a Reference Line

 **Advice!** After a work interruption, or a change in work location, a deviation of the index line can happen due to satellite drift. If the deviation is too much, it may be required to reset the reference line back.

Drive to a known position and reset the reference line.

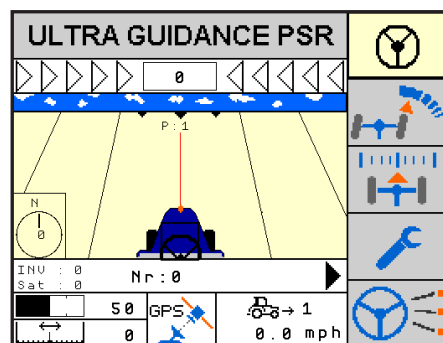

Picture 144:
 Set reference line to zero

5.10.2. Working with Multi-Line

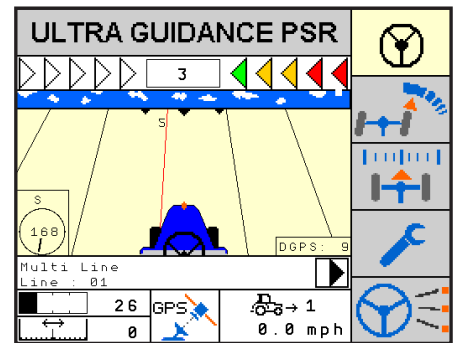

Display: Main screen

When the GPS Multi-line mode is active, new functions appear on the main screen.



Picture 145:
Main screen PSR SKY

Tap the function key  to change the reference line.

 **Advice!** When ULTRA GUIDANCE PSR is activated, pressing the function key  only pre-selects the next reference line.

In the display field **A** the pre-selected reference line number is shown inverse. As soon as ULTRA GUIDANCE PSR ISO is deactivated or the drive mode steering by wire is chosen, the pre-selected reference will be taken on by the system.

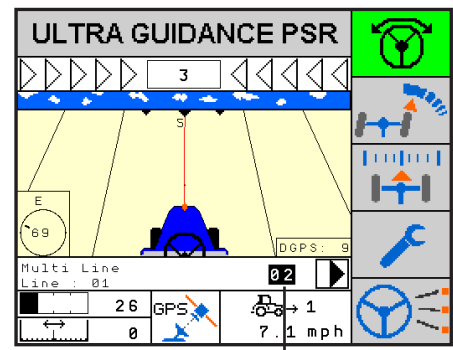

Picture 146:
Pre-selected reference line **A**

If ULTRA GUIDANCE PSR ISO deactivated, the next reference line will be taken on by the system immediately.

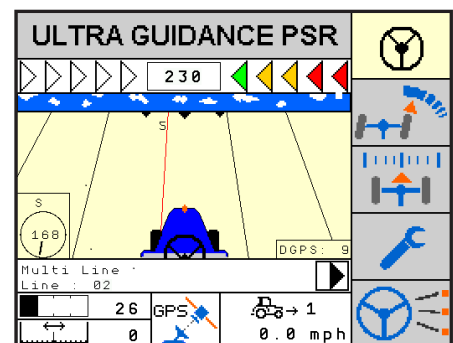

Picture 147:
Acceptance of pre-selected reference line

5.11. PSR SKY Quick Start

Select drive mode

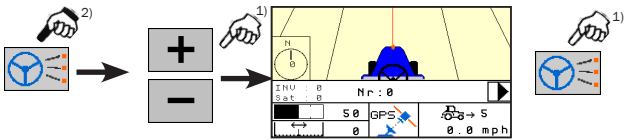

Set A-B / A+

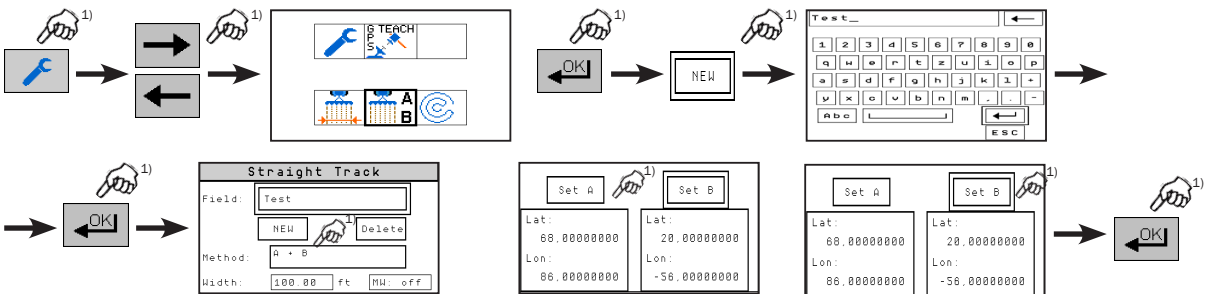

Set circles

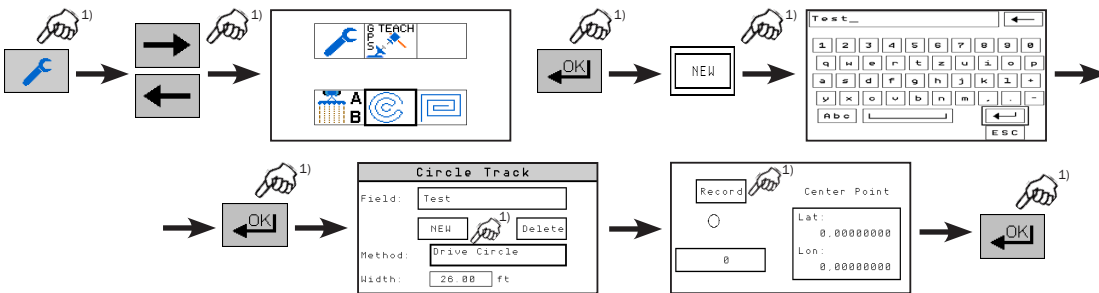

Set implement offset

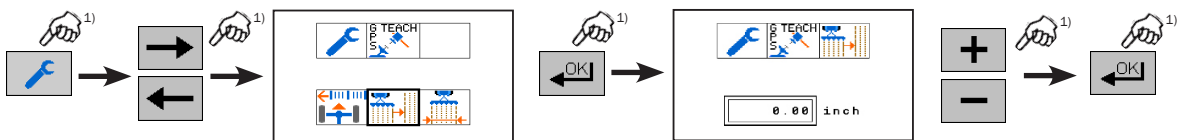

Calibrate reference line

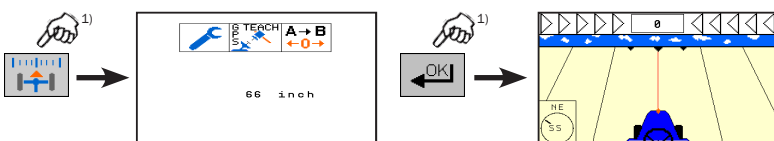

Legend:  Tap.  Press and hold, until there is reaction.

6. PSR SONIC

6.1. Overview Drive mode PSR SONIC

Ultra sound mode ULTRA GUIDANCE PSR ISO SONIC offers the following drive modes:

Drive mode with two sensor pairs



Track Cross

Steering by a given track. This is the ideal drive mode for working fields, spraying or fertilizing.



Track Outside

Steering by better reconcilable outside edges of a track.



Swath Middle

Uses a swath of hay, straw or other a as guide reference.



Swath zig zag

Uses a swath of hay, straw or other a as guide reference.

A load in a baler for example can become one-sided if the swath is small and fed at the same point into the machine. To keep that from happening the vehicle can be guided over the swath left to right and back again.

Drive Mode with one sensor pair



Crop Edge

Uses a crop edge as guide reference. It is possible to switch between crop edge left or right.



Crop Edge Cross wise

This drive mode is used when the reference line used is only on one side (example potato or asparagus).



Crop Edge with Correction

Crop edge guidance with height correction is used when working in hilly terrain to even out height differences.

6.2. Menu structure PSR SONIC

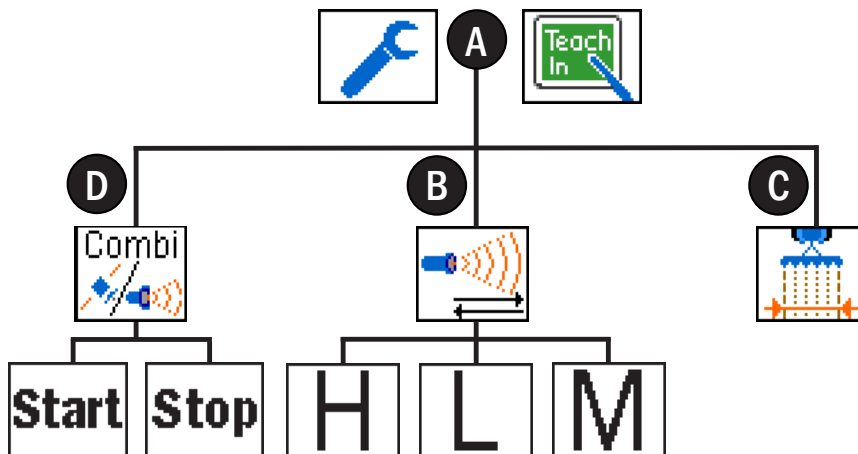

Picture 148:
 Menu structure PSR SONIC

- Ⓐ = Main Menu PSR SONIC
- Ⓑ = Sample Spacing PSR SONIC
- Ⓒ = Working width (When actively coupled)
- Ⓓ = Combined PSR SONIC - PSR SKY

6.3. Adjusting Sensors

The Ultra sound sensors are supported by incrementally adjustable carrier arms. They are manually adjustable to a degree of +/- 75 of vertical.

The carrier arms are mounted to a main carrier frame and are easily adjustable to fit the track of the respective vehicle.

In order to change a sensor direction, loosen the nut on the back side of the sensor mount, reach under the cover and rotate the sensor to the desired direction. Make sure it matches one of the holes provided.

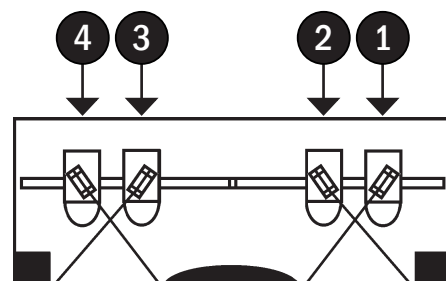

Picture 149:
 Sensor positions

The sensor placement is dependent on the driving mode. Preferably we use the 3rd hole from the middle of the plate.



Advice! The sensor adjustment or distance from the object (crop edge or track angle) should be between 20 and 28 inches. To achieve this dimension we can slide the sensor sideways or raise/lower the carrier frame.



Attention! For trouble free operation, always keep the sensor pairs ①/② and ③/④ together. Also make sure the pairs on each side should be the same distance from the center of the vehicle.

All sensors should be set in the same hole on the mounting plate. Exception: When driving in the crop edge with correction mode. In that configuration the sensor ② and ③ should point straight down.

PSR SONIC sensors can recognize plants when about 4 inches tall.

When creating a marker track (furrow) make sure it looks similar to the sketch provided.

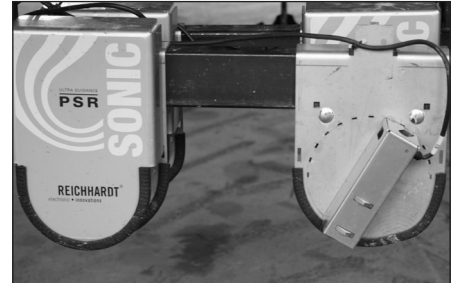

Picture 150:
Adjust sensor

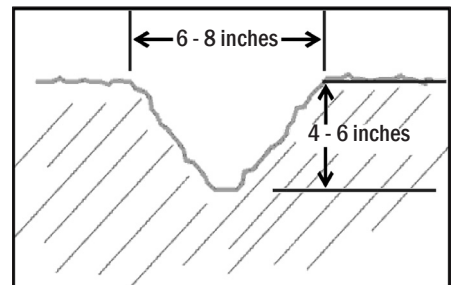

Picture 151:
Track shape

6.4. Main Menu PSR SONIC

Display: Main screen

Tap the function key  to change to the main menu PSR SONIC.

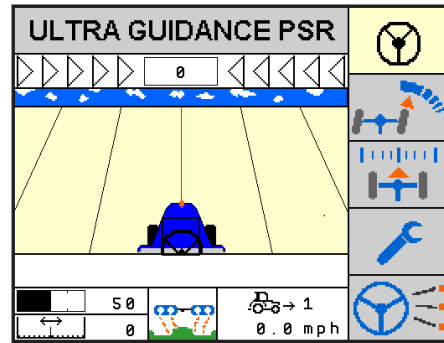

Picture 152:
 Main Menu PSR SONIC

6.4.1. Sample Spacing SONIC

With the sample spacing of the SONIC sensors, the operator can adjust how aggressive the steering correction should be when a deviation from the intended line is recognized.

Choose  and confirm the selection.

 **Advice!** This setting is meant for all PSR SONIC drive modes.

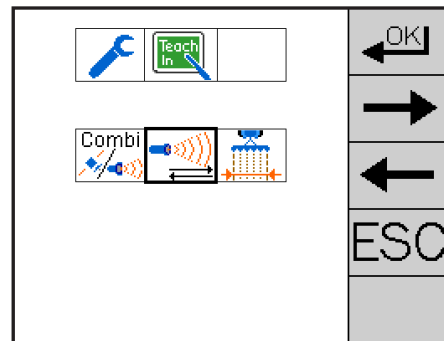

Picture 153:
 Setting of Sensor Sample Spacing

Choose **L** or **M** or **H** and press the function key  until the save screen shows. Proceed as described in chapter 4.12.

- L** = weak sample spacing. The vehicle reacts slower to a deviation.
- M** = normal sample spacing. The vehicle reacts normally to a deviation.
- H** = high sample spacing. The vehicle reacts even to the slightest deviations.

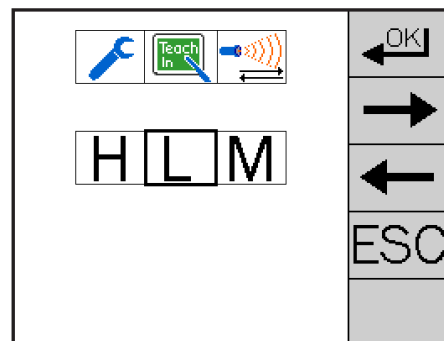

Picture 154:
 Selection of sample spacing

6.4.2. Joint use of PSR SONIC – PSR SKY

The combined use of PSR SONIC – PSR SKY helps when turning at the head land with entering into the next pass with PSR SKY.

In the field the work is done with PSR SONIC.

➔ **Advice!** Additional information and function options are found in chapter 8.

Choose  and confirm the selection.

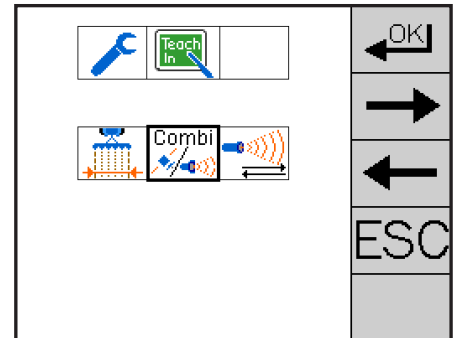

Picture 155:
 Combined PSR SONIC – PSR SKY

Choose **Start** or **Stop** and press the function key  until the save screen shows. Proceed as described in chapter 4.12.

Start = Activate coupling.

Stop = Deactivate coupling.

➔ **Advice!** The coupling for the actual PSR SONIC drive mode setting.

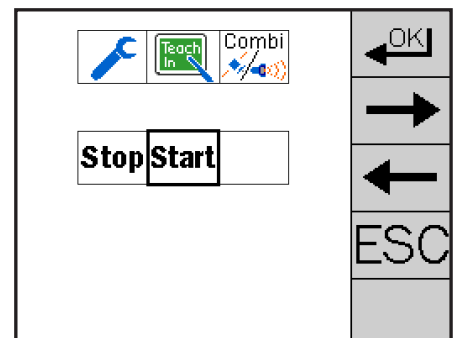

Picture 156:
 Activate coupling

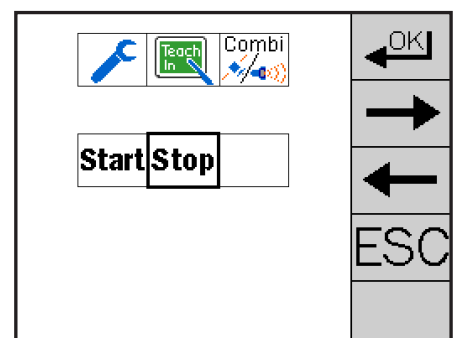

Picture 157:
 Deactivate coupling

6.5. Set working width



When the coupling is active the exact working width has to be set.

Contrary to PSR SKY it is not necessary to set a narrower working width.

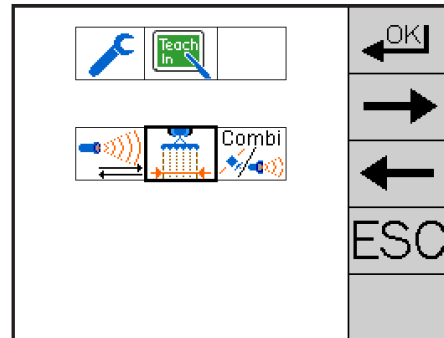
Choose  and confirm the selection.



Picture 158:
 Select setting of working width

Set the working width with the function keys  .

Press and hold the function key  until the stored symbol appears. Proceed as described in chapter 4.12.

 **Advice!** A working width can only be set when the coupling is active during a current PSR SKY mode.

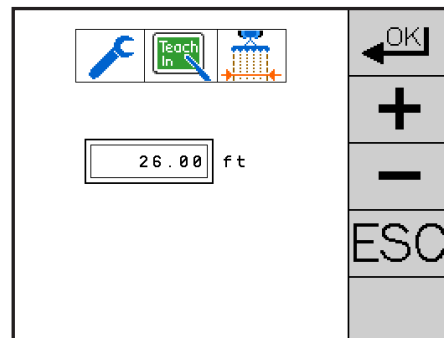

Picture 159:
 Set working width

6.6. PSR SONIC drive modes

All drive mode pictures show the sensors placed as the driver will see them from the drivers seat in forward driving direction.

6.6.1. Track Cross

Display: Main screen

Set drive mode according to the adjoined picture (see chapter 4.5.).

➔ **Advice!** In the drive mode Track Cross a measurement shows a slight deviation to the left or right of the guide line.

Set sensors:

Set sensors according to adjacent picture. Pay attention that the measuring ray hits the inside of the edge to be read.

For setting the distance, use a tape measure.

➔ **Advice!** Depending on the job, it might be advisable to install the sensors behind each other instead of side by side. In that situation, get a double reading of the same track which may improve accuracy. This might be workable when following a marker track when seeding.

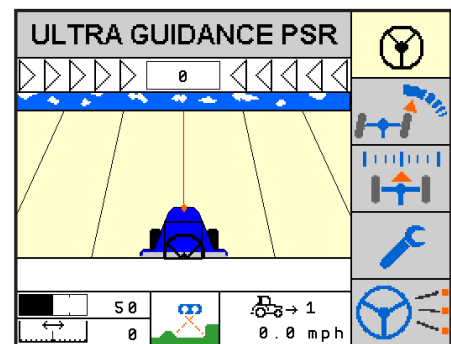

Picture 160:
Main Screen Track Cross

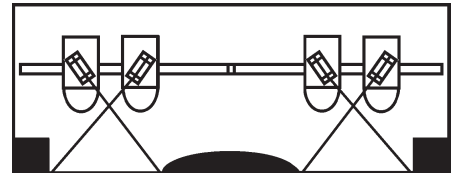

Picture 161:
Sensor Direction Track Cross



Picture 162:
Main Screen Track Cross



Picture 163:
Sensor placement behind one another

6.6.2. Track Outside

Display: Main screen

Set drive mode according to the adjoined picture (see chapter 4.5.).

➔ Advice! In the drive mode Track Outside the distance shows a slight deviation to left or right of the guide line.

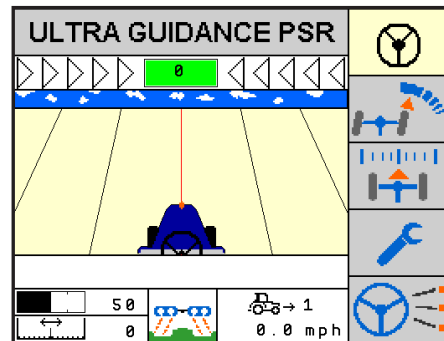

Picture 164:
Main screen Track Outside

Set sensors:

Set sensors according to adjacent picture. Pay attention that the outside sensor hits the upper third of the edge and the inner sensor hits the lower third of the edge.

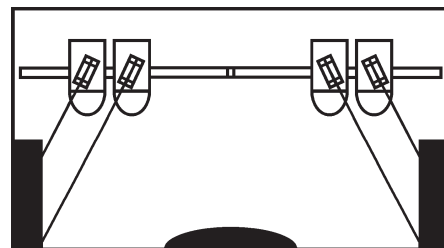

Picture 165:
Sensor direction drive mode Track Outside

6.6.3. Swath Middle/Swath - zig zag

Display: Main screen

Set drive mode according to the adjoined picture (see chapter 4.5.).

Tap the function key  to switch between drive mode Swath Middle and Swath zig zag.

➔ Advice! In the drive mode swath middle and swath zig zag, the distance shows a slight deviation to the left or right of the guide line.

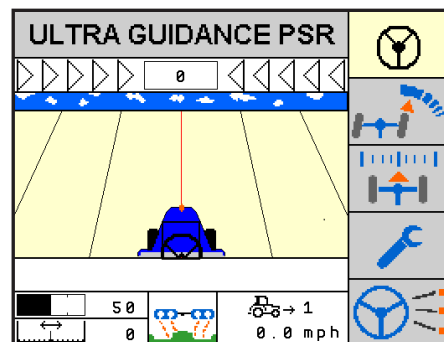

Picture 166:
Main screen Swath Middle

Set sensors:

Set sensors according to adjacent picture. Direct the sensors in such a way that the outside sensors hit the swath on the bottom edge and the inside units hit the swath in the upper area.

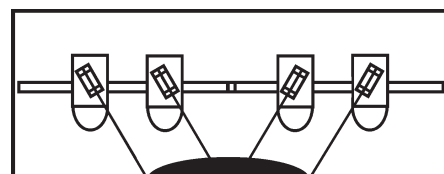



Picture 167:
Sensor direction Swath middle

6.6.4. Crop Edge

Display: Main screen

Set drive mode according to the adjoined picture (see chapter 4.5.).

Tap the function key  to switch between left and right crop edge.

 **Advice!** In the drive mode crop edge the distance shown is the medium distance between the left ①/② or right ③/④ sensor pair to the crop edge.

Set sensors:

Set sensors according to adjacent pictures. Pay attention that the outer sensor hits the upper third and the inner sensor hits the lower third of the crop edge.

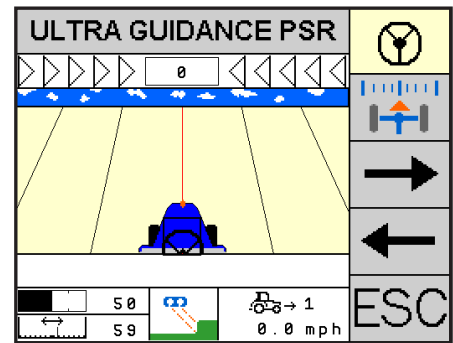

Picture 168:
Main Screen Crop Edge

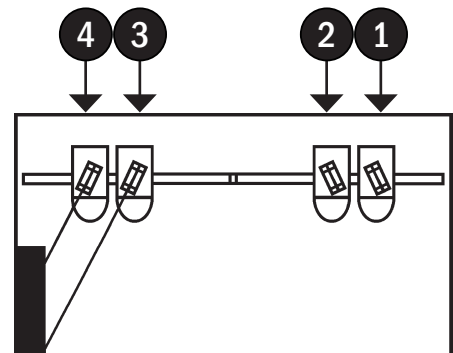

Picture 169:
Sensor direction left crop edge

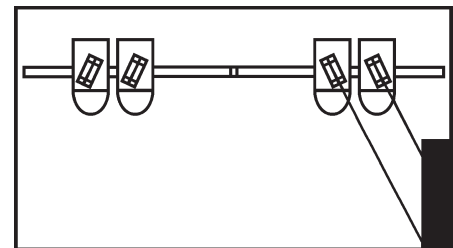



Picture 170:
Sensor direction right crop edge

6.6.5. Crop Edge cross wise

Display: Main screen

Set drive mode according to the adjoined picture (see chapter 4.5.).

Tap the function key  to switch between left and right crop edge cross wise.

 **Advice!** In the drive mode crop edge cross wise the distance shows a slight deviation left or right of the vehicle from the guide line.

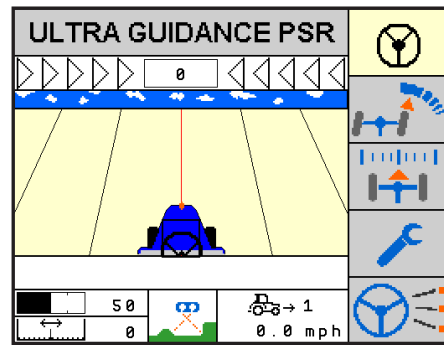

Picture 171:
 Main Screen: crop edge cross wise right

Set sensors:

Set sensors according to adjacent pictures. Pay attention that the measure rays are directed to hit the inside of the corner.

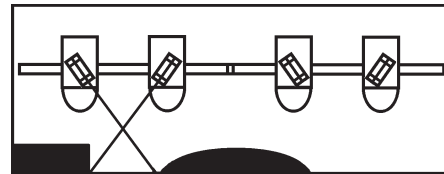

Picture 172:
 Sensor direction left edge cross

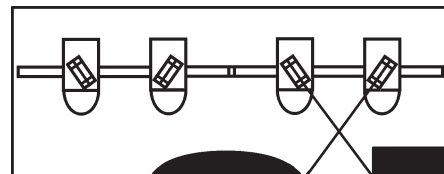

Picture 173:
 Sensor direction right edge cross

6.6.6. Crop Edge with correction

Display: Main screen

Set drive mode according to the adjoined picture (see chapter 4.5.).

Tap the function key  to switch between left and right crop edge with correction.

Advice! In the drive mode crop edge with correction the distance means measurement between the outer sensors ① or ④ to the guide edge.

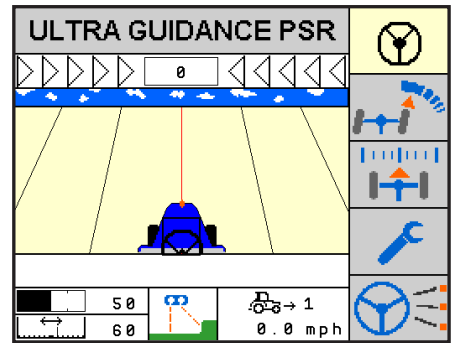

Picture 174:
 Main Screen Crop edge with correction

Set sensors:

Set sensors according to adjacent pictures. Pay attention that the measuring rays of the inner sensors ② and ③ go straight down. The rays of the outer sensors ① and ④ hit the middle of the upper crop edge.

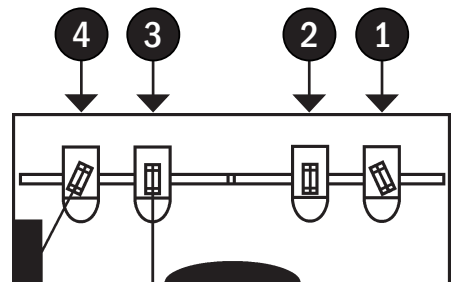

Picture 175:
 Sensor direction edge right correction

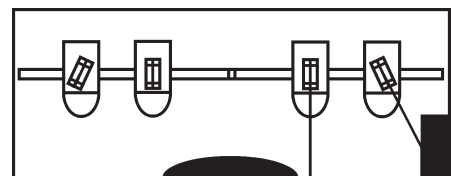

Picture 176:
 Sensor direction edge left correction

6.7. PSR Sonic Quick Start

Select drive mode

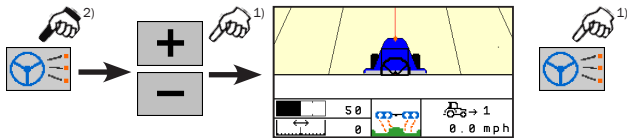

Set sample spacing

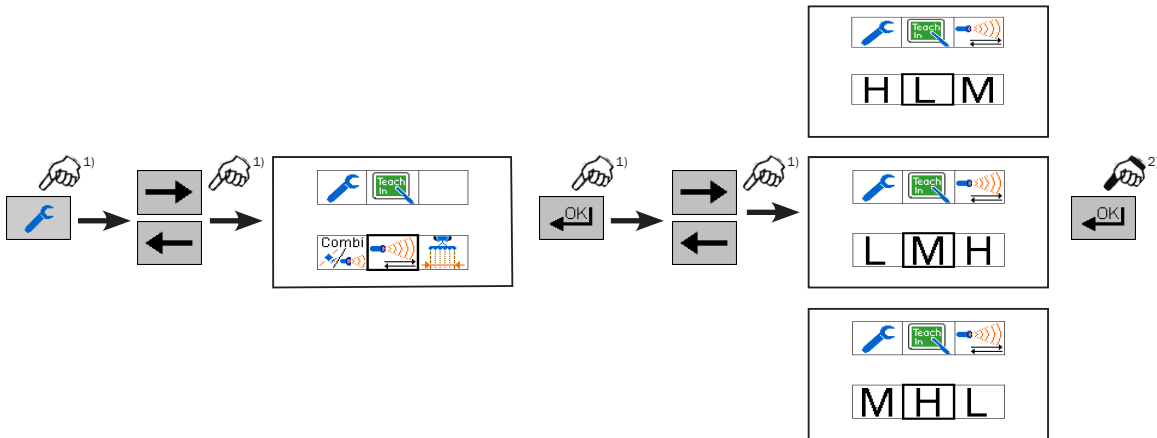

Switching PSR SONIC - PSR SKY on and off

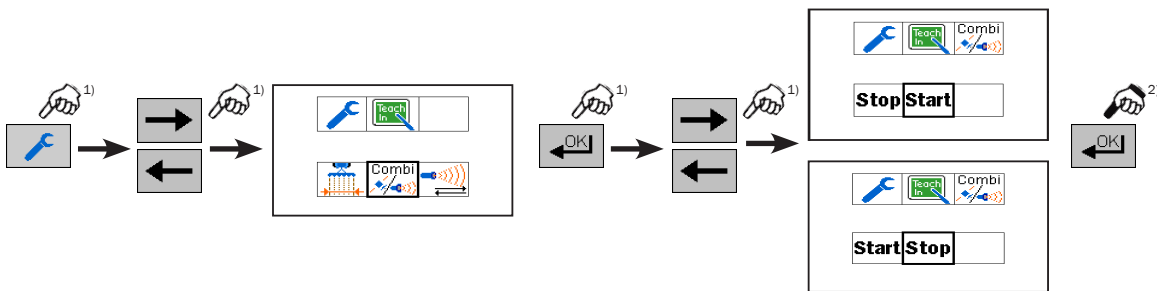

Set working width

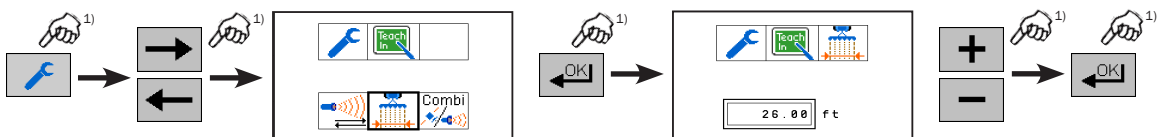

Legend: Tap. Press and hold, until there is reaction.

7. PSR TAC

7.1. Overview Drive mode PSR TAC

The mode ULTRA GUIDANCE PSR ISO TAC offers the following drive modes:



Steering on the basis of a closed row crop row (e.g. corn row)



Steering on the basis of a track with two row crop rows. Only the right TAC sensor is used as a guideline.



Steering on the basis of a track with two row crop rows. Only the left TAC sensor is used as a guideline.



Steering on the basis of any two row crop rows with one-side scanning on the inside.



Uses two row crop rows as a guide.

In case of gaps in the crop, the second TAC sensor can be used to achieve improved driving performance.

7.2. Menu structure PSR TAC

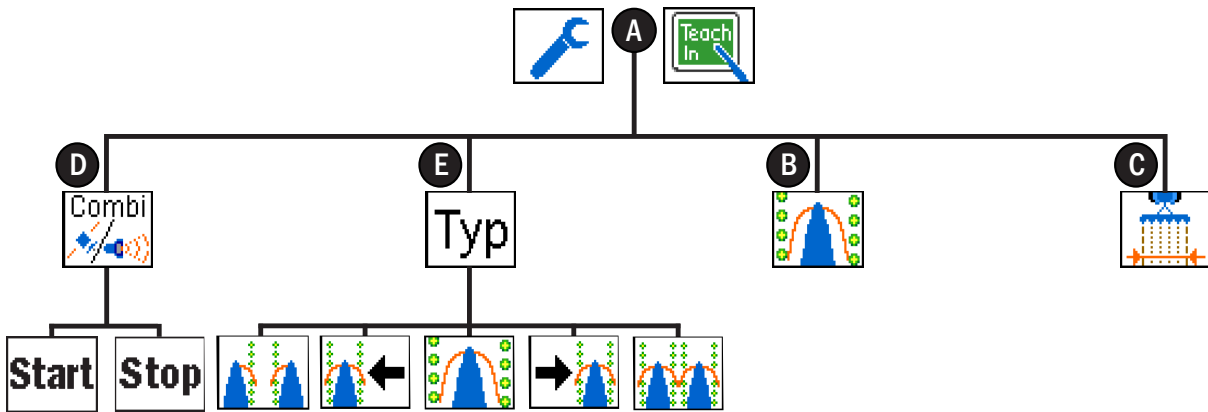

Picture 177:
 Menu structure PSR TAC

- Ⓐ = Main menu PSR TAC
- Ⓑ = TAC sensor calibration
- Ⓒ = Set working width
- Ⓓ = Joint use of PSR TAC – PSR SKY
- Ⓔ = Types of TAC sensors

7.3. Main screen PSR TAC

Display: Main screen

Set drive mode according to the adjoined picture (see chapter 4.5.).



Advice! In drive mode PSR TAC the distance shows a slight deviation of the vehicle to the left or right of the guide line.

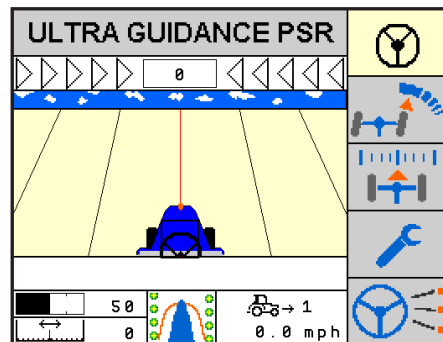

Picture 178:
 Main screen PSR TAC

7.4. Main menu PSR TAC

Display: Main screen

Tap the function key  to change to the main menu PSR TAC.

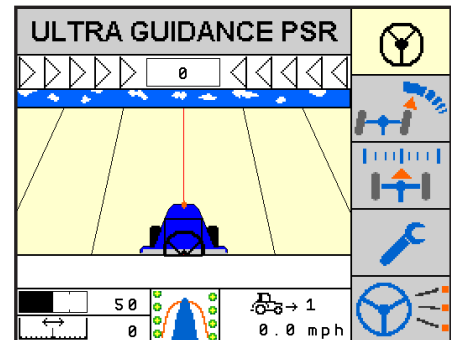

Picture 179:
 Main screen PSR TAC

7.4.1. TAC sensor calibration

Choose  and confirm the selection.

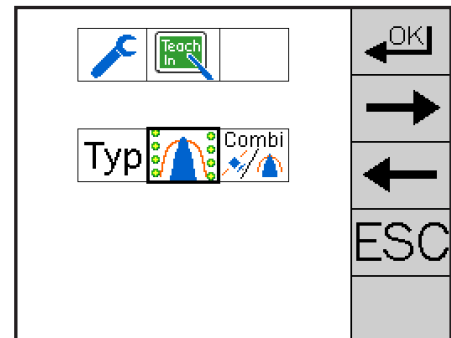

To get consistently good results with the TAC sensor, it is advised re-calibrate it occasionally. Especially during initial use or after lengthy periods of no use.

Make sure the plastic wand is in rest position. It should not touch anything or be moved by any action. Do not touch the sensor. The value should be between 40 and 70.



Picture 180:
 Select TAC sensor

Press and hold the function key  until the stored symbol appears. Proceed as described in chapter 4.12.

 **Advice!** For more consistent results, the vehicle may have two sets of sensors. When pressing the function keys   the operator will first see S1 then S2 then S3 and S4. All sensors will be calibrated together.

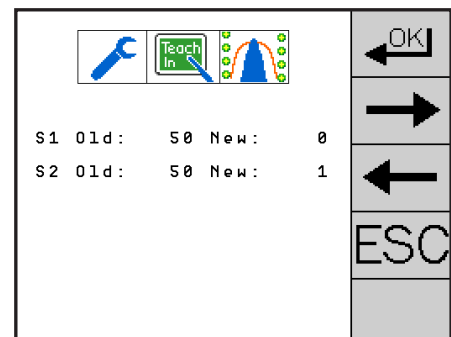

Picture 181:
 Calibrate TAC sensor



7.4.2. Select two TAC sensors

Using the TAC sensors, you can gently and precisely detect vegetation in closed row crops (e.g. corn) and steer the vehicle with maximum precision.

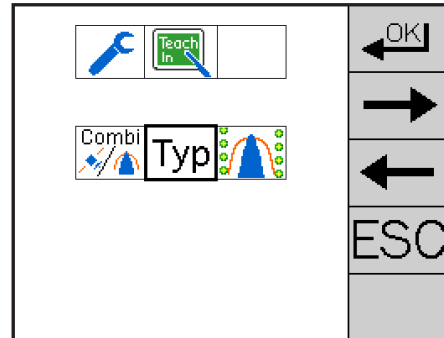
Choose **Typ** and confirm the selection.



Picture 182:
 Select type

Press the function keys ,  to select a method.

Press and hold the function key  until the stored symbol appears. Then proceed as described in chapter 4.12.

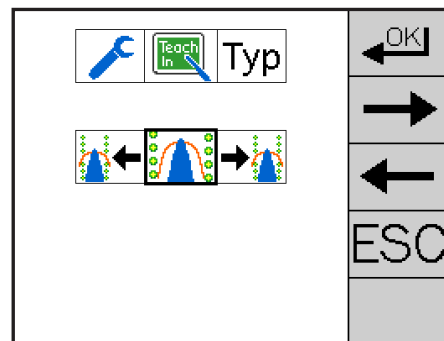



Picture 183:
 Select TAC sensor

7.4.3. Joint use of PSR TAC – PSR SKY

Coupling of PSR TAC – PSR SKY allows for quick and clean reentering of a new pass after turning on the headland with PSR SKY.

In the field, the work is done with the drive mode PSR TAC.

 **Advice!** Additional information and function options are found in chapter 8.

Choose  and confirm the selection.

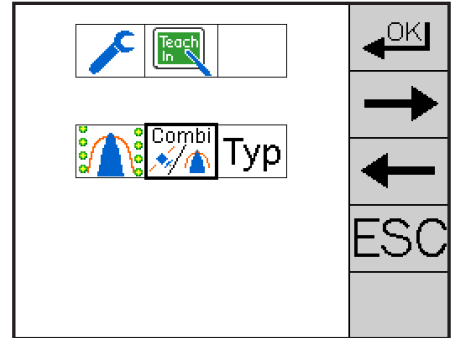

Picture 184:
Coupling of PSR TAC - PSR SKY

Choose **Start** or **Stop** and press the function key .

until the save screen shows. Proceed as described in chapter 4.12.

Start = Activate coupling.

Stop = Deactivate coupling.

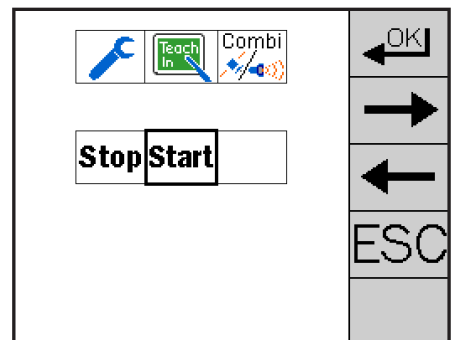

Picture 185:
Activate coupling

 **Advice!** The coupling for the actual PSR TAC drive mode setting.

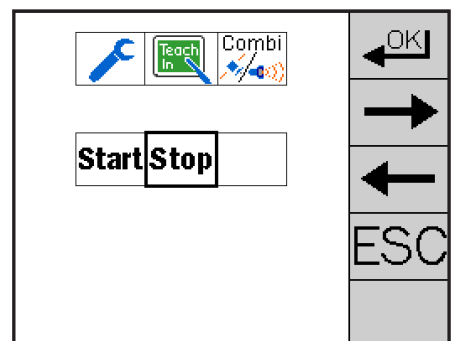

Picture 186:
Deactivate coupling

7.5. Set working width



When the coupling is active the exact working width has to be set.

Contrary to PSR SKY it is not necessary to set a narrower working width.

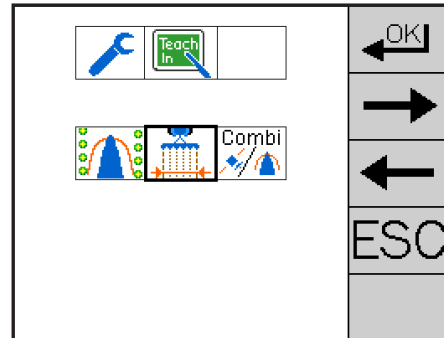
Choose  and confirm the selection.



Picture 187:
 Select setting of working width

Set the working width with the function keys  .

Press and hold the function key  until the stored symbol appears. Proceed as described in chapter 4.12.



Advice! A working width can only be set when the coupling is active during a current PSR TAC mode.

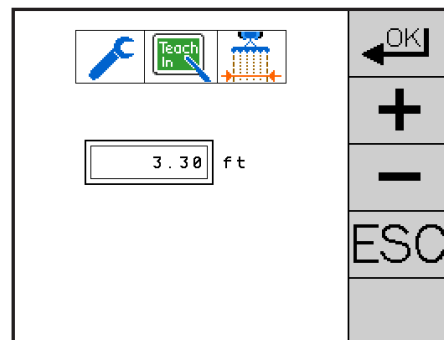

Picture 188:
 Set working width

7.6. PSR TAC Quick Start

Select drive mode

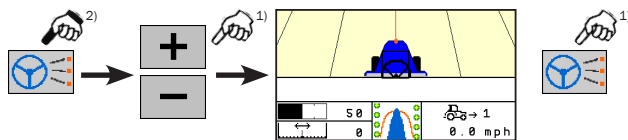

Calibrate TAC sensor

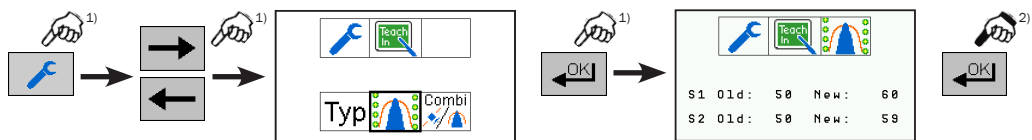

Switching coupling PSR TAC - PSR SKY on and off

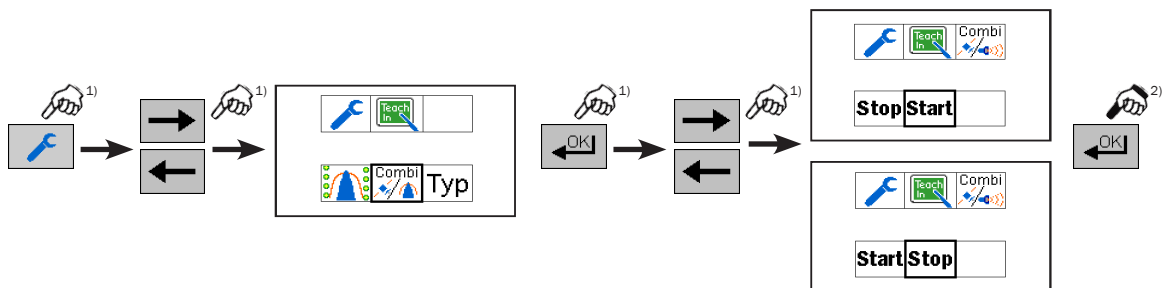

Select TAC sensor

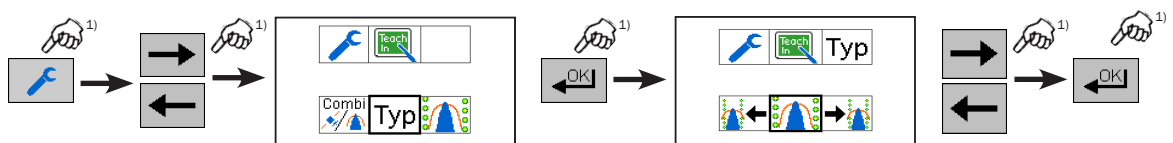

Legend: Tap.

Press and hold, until there is reaction.

8. Coupling of drive modes

The combined use of sensor drive mode and PSR SKY allows for easy and clean reentering after turning on the headland.

The sensor operation is preferred while working the field, but when turning at the end, PSR SKY guides the vehicle into the new pass accurately without time loss.

Example: Spraying corn with TAC: After turning at the end of the row, PSR SKY takes over the entering into the next pass, without any row count or advance marking.

The coupling can be turned on/off in any sensor drive mode.



Advice! When the coupling is activated, switching between automatic drive mode and steering by wire is not possible.

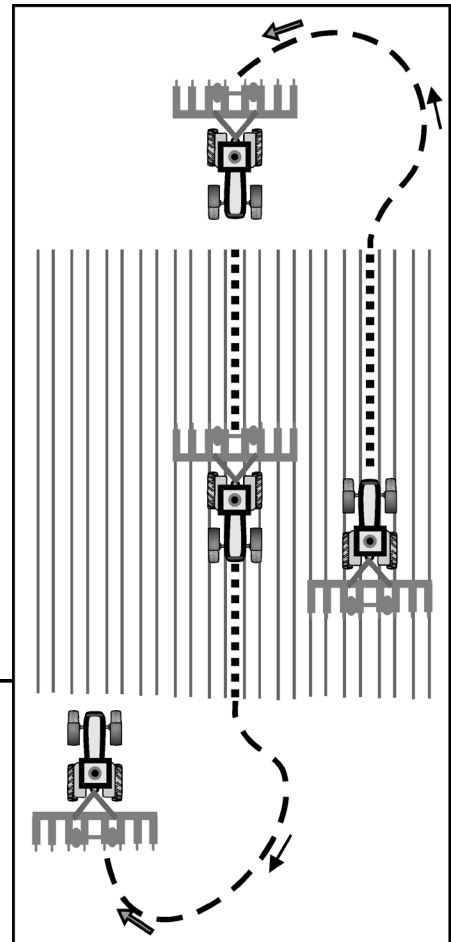
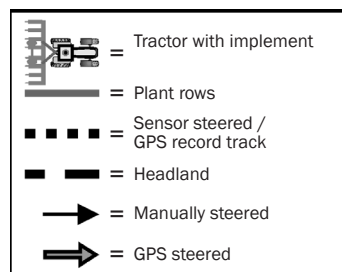

Picture 189: Combined navigation with the help of GPS and Sensors

Display: Main screen

The information field **A** is shown as “Combi”, meaning the coupling is activated.

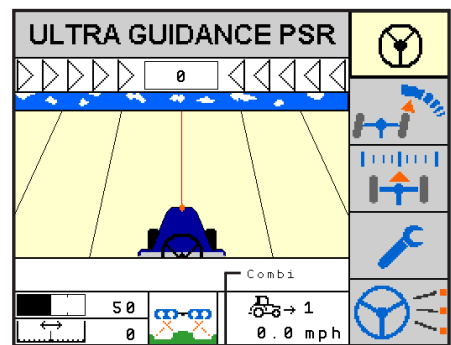

Picture 190: Main Screen sensor drive mode in coupling mode

Semi automatic switching between sensor drive mode PSR SKY

Drive through the field in the sensor drive mode. When the vehicle reaches the end of the field, de-activate the sensor mode by gripping the steering wheel to begin the turn around process.

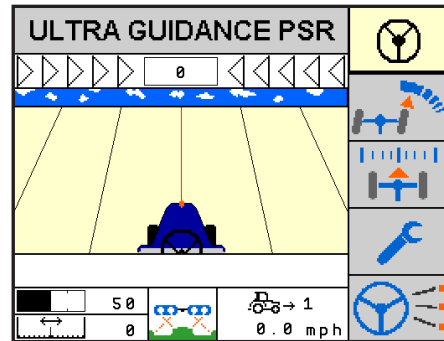

Picture 191:
 Main Screen sensor drive mode in coupling mode

As soon as the vehicle gets near the entrance of the next pass, the system will automatically switch to PSR SKY mode. An audible sound can be heard. This is the queue to activate ULTRA GUIDANCE PSR ISO, and the system takes over the re-enter phase.

➔ Advice! If the vehicle does not enter the next pass within 45 seconds, after deactivating the ULTRA GUIDANCE PSR ISO, an automatic switch to PSR SKY will not happen.

To free the system of automatic switching, travel with ULTRA GUIDANCE PSR ISO activated at least a stretch of 98 ft in a sensor mode.

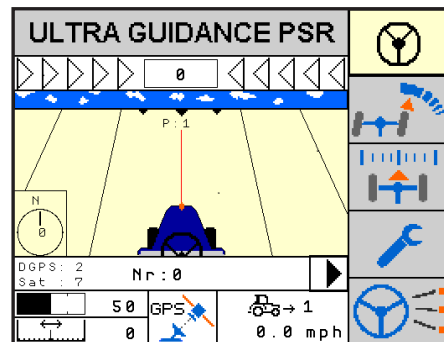

Picture 192:
 Main Screen after switching to PSR SKY

As soon as the vehicle finds itself in a new pass, the system switches back to the sensor mode from before the turn.

➔ Advice! After switching to drive mode PSR SKY, and the steering is not activated within 25 seconds, the drive mode switches automatically back to the previously set sensor mode.

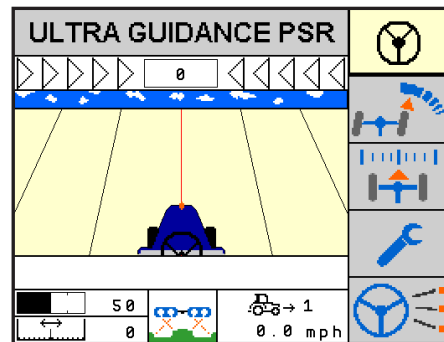

Picture 193:
 Main Screen after switching to Sensor drive mode

Manual switching between sensor drive mode PSR SKY

In certain situations it is advantageous when drive mode PSR SKY is manually checked and held. In case there is an actual obstacle on the head land (power pole etc.) or a tank refill is needed, it will be helpful find the next pass automatically.

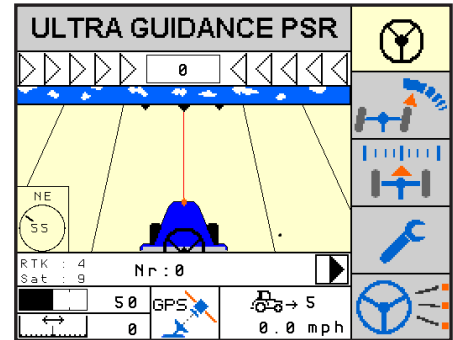

Picture 194:
 Main Screen sensor drive mode in coupling mode

Tap the function key  to switch from sensor drive mode to PSR SKY mode.

Advice! After manually using PSR SKY, the switch back to sensor mode has to be done manually also. It will not happen automatically.

To free the system of automatic switching, travel with ULTRA GUIDANCE PSR ISO activated at least a stretch of 98 ft in a sensor mode.

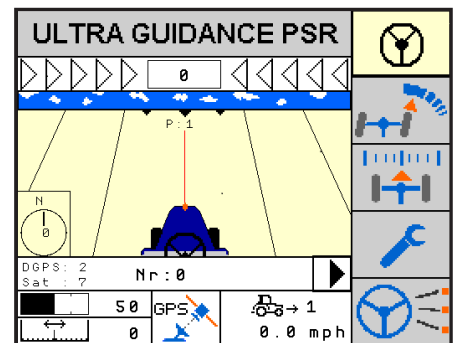

Picture 195:
 Main Screen after switching to PSR SKY

Tap the function key  to switch from PSR SKY to the sensor drive mode.

Advice! A manual switch of the PSR SKY mode into the previous sensor drive mode has no influence on the automatic switching.

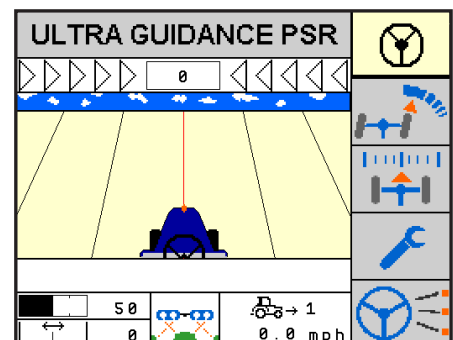

Picture 196:
 Main Screen after switching to Sensor drive mode

9. Work and Storage Conditions

The electronic components of the ULTRA GUIDANCE PSR ISO system, especially the PSR iBox, are designed to be used in adverse conditions. PSR iBox is weather resistant and can be installed outside of the drivers cab.



Advice! Never use a pressure washer on the PSR iBox or any of the harness connections. A wet cloth is recommended.

To extend life expectancy, store components of iBasic which are not permanently installed on the vehicle. Keep all hardware with the components, and store in a proper location. Avoid humidity, moisture, and locations with high temperatures. Avoid storing near windows, heaters, motors or venting systems. Avoid windows with direct sunlight.

10. Troubleshooting

Error-No.:	Description	Cause	Troubleshooting
GPS no Receiver	No GPS receiver connected.	- Open wire between GPS-receiver and PSR iBox.	- Check cables from PSR iBox to GPS-receiver.
		- Fuse B6.1 or B6.2 defective.	- Check fuses in PSR iBox. - Check which signals from the GPS receiver should be evaluated (NMEA 0183, NMEA 2000, J1939 GPS).
No GPS signal	No reception of GPS signals.	- Wrong wires are connected.	- Check whether correct serial port is connected.
		- Wrong baud rate.	- Check settings of GPS-receiver.
GPS Warm Up Please Wait	Reception of GPS signals, but they have to be checked.	- GPS receiver has not yet started correctly.	- Wait until GPS receiver has started correctly. - Drive to a place where you have open view to the sky.
Low GPS-Signal	Poor reception of GPS signals.	- No free view to the sky.	- Drive to a place where you have open view to the sky.
		- Objects (trees, houses etc.) disturb the reception.	
GPS no A-B-line	No A-B line saved under this job no.	- No A-B line saved under this job no.	- Save a new A-B line under current job number. - Select another job number, where an A-B line is saved.
Distance to A too far away	Saved A-B line is too far away.	- Saved A-B line too far away.	- Save new A-B line. - If this A-B line is to be driven, the vehicle must be moved closer to the position at which the A-B line was saved.
Too many GPS Lines	Position outside range.	- The system can register +- 10000 lines.	- Save new A-B line. - Drive to range of +- 10000 lines.
GPS no RMC	No GPRMC message received from GPS receiver.	- GPS receiver incorrectly configured.	- The GPS receiver must be reconfigured.
GPS no GGA	No GPGGA message received from GPS receiver.	- GPS receiver incorrectly configured.	- The GPS receiver must be reconfigured.
GPS no VTG	No GPVTG message received from GPS receiver.	- GPS receiver incorrectly configured.	- The GPS receiver must be reconfigured.
GPS J1939 No VP	No J1939 VP message received from GPS receiver.	- GPS receiver incorrectly configured.	- The GPS receiver must be reconfigured.
GPS J1939 No VDS	No J1939 VDS message received from GPS receiver.	- GPS receiver incorrectly configured.	- The GPS receiver must be reconfigured.

Error-No.:	Description	Cause	Troubleshooting
NMEA 2000 No RDU	No NMEA 2000 RDU message received from GPS receiver.	- GPS receiver incorrectly configured.	- The GPS receiver must be reconfigured.
NMEA 2000 No CSD	No NMEA 2000 CSD message received from GPS receiver.	- GPS receiver incorrectly configured.	- The GPS receiver must be reconfigured.
NMEA 2000 No PD	No NMEA 2000 PD message received from GPS receiver.	- GPS receiver incorrectly configured.	- The GPS receiver must be reconfigured.
Lost RTK	Loss of RTK quality in GPS receiver.	- GPS receiver receiving a lower quality than RTK.	- Check reference age of base station.
Lost DGPS	Loss of DGPS quality in GPS receiver.	- GPS receiver receiving a lower quality than DGPS .	- Check reference age from correction satellite.
GPS update rate too slow	GPS receiver sends insufficient # of messages per second.	- GPS receiver incorrectly configured.	- The GPS receiver must be reconfigured.
Terminal Version	Terminal version is too old.	- After Software update from PSR iBox, it may be necessary to transfer a new version to the PSR cBox.	- Update the PSR cBox with the version shown on the display.
PSR no license	Invalid Hardware.	- The used hardware is not compatible for this software.	- Contact your Reichhardt support.
Select Steering mode	No drive mode selected.	- No drive mode selected yet.	- Please select a drive mode.
		- The time for a certain drive mode has expired.	- Contact your Reichhardt support.
New license not possible	No additional scheduled activation of a drive mode can be made.	- This drive mode has already been activated 3 times.	- Contact your Reichhardt support.
Timeout license end	The time for a certain drive mode has expired.	- The scheduled activation has expired.	- Contact your Reichhardt support.
Last shut down bad	An error occurred during the last shutdown.	- The battery is not connected properly.	- Check to see if the battery is connected.
		- A software error has occurred.	- Contact your Reichhardt support.
1000	No signal from the wheel angle sensor.	- Short circuit in cable.	- Check the plug-in connections of the wheel angle sensor.
		- Open wire in cable.	- Check the cables from PSR iBox to the wheel angle sensor.
		- Sensor is defective.	- If all connections and lines are in proper working order, replace the wheel angle sensor.
		- Contacts of connectors are opened.	- Check contacts of connectors.

Error-No.:	Description	Cause	Troubleshooting
1001	Angle sensor does not work correctly.	- Axis is driven to block.	- Check mechanism of wheel angle sensor.
		- Mechanism or suspension of wheel angle sensor defective.	- For new angle sensors, the sensor has to be calibrated through the "teach-in" page.
		- A new wheel angle sensor was built in wrong.	
		- An obstacle prevents the movement of the axis.	
1010	Wheel angle sensor not in valid range	- Mechanism is defective.	- Check sensor mounting.
		- Open wire in cable.	- Check the cables from PSR iBox to the wheel angle sensor.
		- Sensor is defective.	- Check sensor.
		- Contacts of connectors are opened.	- Check contacts of connectors.
1019	Left and right angle sensors running apart.	- Wheels run too far apart.	- Turn wheels from full left to full right.
		- Open wire in cable.	- Check the cables from PSR iBox to the wheel angle sensor.
		- Sensor is defective.	- Check sensor.
		- Contacts of connectors are opened.	- Check contacts of connectors.
1020	Cabin door is open.	- Cabin door is open.	- Close cabin door.
		- Open wire in cable.	- Check the cables from PSR iBox to door switches.
		- Door switches are defective.	- Check door switches.
		- Contacts of connectors are opened.	- Check contacts of connectors.
1040	Pressure sensor open wire.	- Pressure sensor is defective.	- Visual control of pressure sensor.
		- Open wire in cable.	- Check the cables from PSR iBox to the pressure sensor.
		- Bolted connection of pressure sensor is not correct.	- Check bolted connection of pressure sensor.
		- Contacts of connectors are opened.	- Check contacts of connectors.
1041	Pressure sensor short circuit.	- Pressure sensor is defective.	- Visual control of pressure sensor.
		- Short circuit in cable.	- Check the cables from PSR iBox to the pressure sensor.
		- Bolted connection of pressure sensor is not correct.	- Check bolted connection of pressure sensor.
		- Contacts of connectors are closed.	- Check contacts of connectors.

Error-No.:	Description	Cause	Troubleshooting
1080	Gyroscope open wire.	- Gyroscope is defective.	- Visual control of gyroscope.
		- Open wire in cable.	- Check the cables from PSR iBox to the gyroscope.
		- Contacts of connectors are opened.	- Check contacts of connectors.
1081	Gyroscope short circuit.	- Gyroscope is defective.	- Visual control of gyroscope.
		- Short circuit in cable.	- Check the cables from PSR iBox to the gyroscope.
		- Contacts of connectors are closed.	- Check contacts of connectors.
1082	Gyroscope no reaction.	- Gyroscope is defective.	- Visual control of gyroscope.
			- Check the cables from PSR iBox to the gyroscope.
			- Check contacts of connectors.
			- Check analog value in diagnostic menu.
1084	Gyroscope value not in valid range.	- Too sharp a turn with too high speed.	- See 1082.
			- Reduce speed.
			- Make wider turn.
1085	Gyroscope average value is out of range.	- Speed signal is defective.	- See 1082.
		- Gyroscope is defective.	
1086	Constant speed is not allowed together with gyroscope.	- Constant speed is set in the system.	- Manual speed entry needs to be adjusted by a service technician.
1100	TAC sensor left open wire.	- TAC sensor is defective.	- Visual control of TAC sensor.
		- Open wire in cable.	- Check the cables from PSR iBox to the TAC sensor.
		- Contacts of connectors are opened.	- Check contacts of connectors.
1101	TAC sensor left short circuit.	- TAC sensor is defective.	- Visual control of TAC sensor.
		- Short circuit in cable.	- Check the cables from PSR iBox to the TAC sensor.
		- Contacts of connectors are closed.	- Check contacts of connectors.
1102	TAC sensor right open wire.	- TAC sensor is defective.	- Visual control of TAC sensor.
		- Open wire in cable.	- Check the cables from PSR iBox to the TAC sensor.
		- Contacts of connectors are opened.	- Check contacts of connectors.
1103	TAC sensor right short circuit.	- TAC sensor is defective.	- Visual control of TAC sensor.
		- Short circuit in cable.	- Check the cables from PSR iBox to the TAC sensor.
		- Contacts of connectors are closed.	- Check contacts of connectors.

Fehler-Nr.:	Description	Cause	Troubleshooting
1104	TAC sensor 2 left open wire.	- TAC sensor is defective.	- Visual control of TAC sensor.
		- Open wire in cable.	- Check the cables from PSR iBox to the TAC sensor.
		- Contacts of connectors are opened.	- Check contacts of connectors.
1105	TAC sensor 2 left short circuit.	- TAC sensor is defective.	- Visual control of TAC sensor.
		- Short circuit in cable.	- Check the cables from PSR iBox to the TAC sensor.
		- Contacts of connectors are closed.	- Check contacts of connectors.
1106	TAC sensor 2 right open wires.	- TAC sensor is defective.	- Visual control of TAC sensor.
		- Open wire in cable.	- check the cables from PSR iBox to the TAC sensor.
		- Contacts of connectors are opened.	- Check contacts of connectors.
1107	TAC sensor 2 right short circuit.	- TAC sensor is defective.	- Visual control of TAC sensor.
		- Short circuit in cable.	- Check the cables from PSR iBox to the TAC sensor.
		- Contacts of connectors are closed.	- Check contacts of connectors.
1150	Rowfeeler open wire.	- Rowfeeler is defective.	- Visual control of rowfeeler.
		- Open wire in cable.	- Check cables from PSR iBox to rowfeeler.
		- Contacts of connectors are opened.	- Check contacts of connectors.
1151	Rowfeeler short circuit.	- Rowfeeler is defective.	- Visual control of rowfeeler.
		- Short circuit in cable.	- Check cables from PSR iBox to rowfeeler.
		- Contacts of connectors are closed.	- Check contacts of connectors.
1200	Camera no reaction.	- Camera is defective.	- Visual control of camera.
		- Open wire in cable.	- Check cables from PSR iBox to camera.
		- Contacts of connectors are opened.	- Check contacts of connectors.
1210	No signal from camera while operating.	- Camera is defective.	- Visual control of camera.
		- Open wire in cable.	- Check cables from PSR iBox to camera.
		- Contacts of connectors are opened.	- Check contacts of connectors.
1220	No valid signals from camera.	- Adjustment of camera is incorrect.	- Check mounting of the camera.
		- Distance between camera and plants is too small.	- Check parameters/adjustments of the camera.
		- There's excess vegetation between plantrows.	- Clean camera lens.
			- Use additional lighting when ambient lighting is poor.

CHAPTER TROUBLESHOOTING

Error-No.:	Description	Cause	Troubleshooting
1350	Speed is too fast.	- Vehicle speed is too fast.	- Reduce speed and activate system again.
1351	No ISO-GBSD message received.	- Tractor ECU does not support the ISO speed message.	- Select another speed sensor.
1352	No ISO-WBSD message received.	- Tractor ECU does not support this ISO speed message.	- Select another speed sensor.
1353	No valid message on ISO speed received.	- Tractor ECU sending invalid speed data.	- Select another speed sensor.
1400	Ultra sonic 1 open wire.	- Ultra sonic 1 is defective.	- Visual control of ultra sonic 1.
		- Open wire in cable.	- Check the cables from PSR iBox to ultra sonic 1.
		- Contacts of connectors are opened.	- Check contacts of connectors.
1401	Ultra sonic 2 open wire.	- Ultra sonic 2 is defective.	- Visual control of ultra sonic 2.
		- Open wire in cable.	- Check the cables from PSR iBox to ultra sonic 2.
		- Contacts of connectors are opened.	- Check contacts of connectors.
1402	Ultra sonic 3 open wire.	- Ultra sonic 3 is defective.	- Visual control of ultra sonic 3.
		- Open wire in cable.	- Check the cables from PSR iBox to ultra sonic 3.
		- Contacts of connectors are opened.	- Check contacts of connectors.
1403	Ultra sonic 4 open wire.	- Ultra sonic 4 is defective.	- Visual control of ultra sonic 4.
		- Open wire in cable.	- Check the cables from PSR iBox to ultra sonic 4.
		- Contacts of connectors are opened.	- Check contacts of connectors.
1404	All ultra sonic open wire.	- Connector is disconnected from the front plug box.	- Visual control of all ultra sonics.
		- Open wire at ground or start signal.	- Check the cables of the PSR iBox to all ultra sonic.
		- Contacts of connectors are opened.	- Check contacts of connectors.
1410	Ultra sonic 1 no signal.	- Object outside detection area.	- Visual control of ultra sonic 1.
			- Check sensor position.
1411	Ultra sonic 2 no signal.	- Object outside detection area.	- Visual control of ultra sonic 2.
			- Check sensor position.
1412	Ultra sonic 3 no signal.	- Object outside detection area.	- Visual control of ultra sonic 3.
			- Check sensor position.

Error-No.:	Description	Cause	Troubleshooting
1413	Ultra sonic 4 no signal.	- Object outside detection area.	- Visual control of ultra sonic 4.
			- Check sensor position.
1414	All ultra sonic no signal.	- Object outside detection area of all sensors.	- Check sensor positions.
1500	Lock valve left open wire.	- Lock valve is defective.	- Visual control of lock valve.
		- Open wire in cable.	- Check the cables from PSR iBox to the lock valve.
		- Contacts of connectors are opened.	- Check contacts of connectors.
1501	Lock valve left short circuit.	- Lock valve is defective.	- Visual control of lock valve.
		- Short circuit in cable.	- Check the cables from PSR iBox to the lock valve.
		- Contacts of connectors are closed.	- Check contacts of connectors.
1502	Lock valve right open wire.	- Lock valve is defective.	- visual control of lock valve.
		- open wire in cable.	- check the cables from PSR iBox to the lock valve.
		- contacts of connectors are opened.	- check contacts of connectors.
1503	Lock valve right short circuit.	- Lock valve is defective.	- Visual control of lock valve.
		- Short circuit in cable.	- Check the cables from PSR iBox to the lock valve.
		- Contacts of connectors are closed.	- Check contacts of connectors.
1550	Steer valve left open wire.	- Steer valve is defective.	- Visual control of steer valve.
		- Open wire in cable.	- Check cables from PSR iBox to steer valve.
		- Contacts of connectors are opened.	- Check contacts of connectors.
1551	Steer valve left short circuit.	- Steer valve is defective.	- Visual control of steer valve.
		- Short circuit in cable.	- Check cables from PSR iBox to steer valve.
		- Contacts of connectors are closed.	- Check contacts of connectors.
1552	Steer valve right open wire.	- Steer valve is defective.	- Visual control of steer valve.
		- Open wire in cable.	- Check cables from PSR iBox to steer valve.
		- Contacts of connectors are opened.	- Check contacts of connectors.
1553	Steer valve right short circuit.	- Steer valve is defective.	- Visual control of steer valve.
		- Short circuit in cable.	- Check cables from PSR iBox to steer valve.
		- Contacts of connectors are closed.	- Check contacts of connectors.
1700	Front plug no voltage.	- Outlet at the PSR iBox is defective.	- Check cables from PSR iBox to front plug box.
		- Short circuit in cable.	

Error-No.:	Description	Cause	Troubleshooting
1701	Start signal ultra sonic no voltage.	- Outlet at the PSR iBox is defective. - Short circuit in cable.	- Check cables from PSR iBox to front plug box.
1702	GPS no voltage.	- Outlet at the PSR iBox is defective. - Short circuit in cable.	- Check cables from PSR iBox to GPS-receiver.
1703	Sensors no voltage.	- Outlet at the PSR iBox is defective. - Short circuit in cable.	- Check the cables from PSR iBox to all sensors.
1710	No voltage relay input-side.	- Fuse defective.	- Check fuses in PSR iBox and supply lines.
		- Supply voltage for outlets not yet switched on.	- Check whether supply voltages are switched on.
1711	No voltage relay output-side.	- Relay in iBox Lt is defective.	- Contact your Reichhardt support.
2100	Incremental axle.	- no pulse signal at channel A.	- Check cables from PSR iBox to incremental sensor (for example: RDU).
2101	Incremental axle.	- no pulse signal at channel B.	- Check cables from PSR iBox to incremental sensor (for example: RDU).
2102	Incremental axle.	- no pulse signal at channel A and B.	- Check cables from PSR iBox to incremental sensor (for example: RDU).
2150	John Deere Autotrac.	- No communication.	- Check cables from PSR iBox to JD Autotrac Motor.
2200	Footswitch defective.	- Footswitch engaged too long.	- Check footswitch.
		- Short circuit in cable.	- Check the cables of the PSR iBox to footswitch.
		- Footswitch defective.	
2300	ISO Cat hydraulic main switch off.	- The hydraulics are disengaged by switch.	- Check hydraulic switch.
2301	ISO Cat communication error.	- Poor CAN connection.	- Check cables from PSR iBox to CAT CAN-Bus.
		- Activate ISO implementation level 3 on the CAT screen.	- Activate ISO level 3 on the CAT screen.
2310	ISO Fendt communication error Can Bus 1.	- no information from Can Bus received.	- Contact your Reichhardt support.
2311	ISO Fendt communication error Can Bus 2.	- No information from Can Bus received.	- Contact your Reichhardt support.
2315	ISO AGCO combine harvester communication error Can Bus 1.	- no information from Can Bus received.	- Contact your Reichhardt support.
2316	ISO AGCO combine harvester communication error Can Bus 2.	- No information from Can Bus received.	- Contact your Reichhardt support.
2317	ISO AgriFac communication error.	- No information from Can Bus received.	- Contact your Reichhardt support.

Error-No.:	Description	Cause	Troubleshooting
2320	ISO Challenger tractor MT 675 C communication error Can Bus 1.	- Steering disengaged by the switch.	- Check whether steering has been activated.
2321	ISO Challenger tractor MT 675 C communication error Can Bus 2.	- No information from Can Bus received.	- Contact your Reichhardt support.
2325	ISO Challenger tractor 900 C communication error.	- No information from Challenger 900 C received.	- Contact your Reichhardt support.
2330	CLAAS XERION communication error.	- No information from XERION received.	- Check cables between PSR iBox and the connection of second CAN bus.
2335	CLAAS LEXION communication error.	- No information from LEXION received.	- Check cables between PSR iBox and the connection of second CAN bus.
2340	Krone Big X / Big M communication error.	- No connection established to Krone Steering Controller.	- Contact your Reichhardt support.
2350	CAN BUS 2 communication error.	- Poor CAN connection.	- Check cables between PSR iBox and the connection of second CAN bus.
2400	Tilt sensor open wire.	- Sensor is defective. - Open wire in cable. - Contacts of connectors are opened.	- Check the cables from PSR iBox to the tilt sensor.
2401	Tilt sensor short circuit.	- Sensor is defective. - Short circuit in cable. - Contacts of connectors are closed.	- Check the cables from PSR iBox to the tilt sensor.
2402	Tilt sensor not connected.	- Sensor is defective. - Open wire in cable. - Contacts of connectors are opened.	- Check the cables from PSR iBox to the tilt sensor.
2403	Tilt sensor no reaction.	- Sensor is defective. - Open wire in cable. - Contacts of connectors are opened.	- Check the cables from PSR iBox to the tilt sensor.
2410	Not activated by Krone.	- Steering via terminal or footswitch activated.	- Must be activated via the joystick.
3001	Vehicle code for vehicle 1 invalid.	- Invalid or not yet valid vehicle code entered.	- Enter a valid vehicle code for vehicle 1.
3002	Vehicle code for vehicle 2 invalid.	- Invalid or not yet valid vehicle code entered.	- Enter a valid vehicle code for vehicle 2.
3003	Vehicle code for vehicle 3 invalid.	- Invalid or not yet valid vehicle code entered.	- Enter a valid vehicle code for vehicle 3.

Error-No.:	Description	Cause	Troubleshooting
3004	Vehicle code for vehicle 4 invalid.	- Invalid or not yet valid vehicle code entered.	- Enter a valid vehicle code for vehicle 4.
3005	Vehicle code for vehicle 5 invalid.	- Invalid or not yet valid vehicle code entered.	- Enter a valid vehicle code for vehicle 5.
3006	Vehicle code for vehicle 6 invalid.	- Invalid or not yet valid vehicle code entered.	- Enter a valid vehicle code for vehicle 6.
3007	Vehicle code for vehicle 7 invalid.	- Invalid or not yet valid vehicle code entered.	- Enter a valid vehicle code for vehicle 7.
3008	Vehicle code for vehicle 8 invalid.	- Invalid or not yet valid vehicle code entered.	- Enter a valid vehicle code for vehicle 8.
3010	Left axle position is not calibrated.	- Left axle position is not calibrated.	- Teach left axle position.
3011	Center axle position is not calibrated.	- Center axle position is not calibrated.	- Teach center axle position.
3012	Right axle position is not calibrated.	- Right axle position is not calibrated.	- Teach right axle position.
3013	Current controller is not calibrated.	- Current controller is not calibrated.	- Teach current controller.
3014	Pressure sensor is not calibrated.	- Pressure sensor is not calibrated.	- Teach pressure sensor neutral position.
3015	TAC-sensor is not calibrated.	- TAC-sensor is not calibrated.	- Teach TAC-sensor neutral position.
3016	Rowfinder is not calibrated.	- Rowfinder is not calibrated.	- Teach rowfinder neutral position.
3017	GPS antenna high is not calibrated.	- GPS antenna high is not calibrated.	- Teach mounted height of GPS-receiver.
3018	GPS antenna offset left - right is not calibrated.	- GPS antenna offset left - right is not calibrated.	- Teach left and right offset of GPS-receiver center position.
3019	GPS antenna look ahead is not calibrated.	- GPS antenna look ahead is not calibrated.	- Teach look ahead of GPS-receiver.
4000	No communication to TVWA.	- No CAN information is received from TVWA.	- Check cables from PSR iBox to TVWA. - Check vehicle code.
4020	No communication to Braud.	- No CAN information is received from Braud.	- Contact the software department.
4021	No communication to Braud.	- No CAN information is received from Braud.	- Contact the software department.
4022	No communication to Braud.	- No CAN information is received from Braud.	- Contact the software department.
4023	No communication to Braud.	- No CAN information is received from Braud.	- Contact the software department.
4024	No communication to Braud.	- No CAN information is received from Braud.	- Contact the software department.

Error-No.:	Description	Cause	Troubleshooting
9100	EEPROM write error.	- EEPROM is defective. - EEPROM is busy.	- Contact the software department.
9101	EEPROM write error.	- EEPROM is defective. - EEPROM is busy.	- Contact the software department.
9102	EEPROM parameters must be checked.	- Older software installed.	- Check all parameters and settings.
9103	EEPROM parameters were changed automatically.	- After a software update, it is necessary in some cases to set parameters to the default values.	
9104	EEPROM parameters outside valid range.	- After readout at least one parameter was outside valid range and was set to default.	- Contact the software department.
9991	Task 1 running time exceeded.	- Task 1 requires too much computing time.	- Contact the software department.
9992	Task 2 running time exceeded.	- Task 2 requires too much computing time.	- Contact the software department.
9993	Task 3 running time exceeded.	- Task 3 requires too much computing time.	- Contact the software department.
9994	Task 4 running time exceeded.	- Task 4 requires too much computing time.	- Contact the software department.
9997	USER stack overflow.	- USER stack size too small.	- Contact the software department.
9998	Internal computing error.	- Function has computing problems.	- Contact the software department.
9999	Error ISO - Lib.	- Error has occurred within ISO - Lib.	- Please take a note of the "Error ISO" number. This is located in the Diagnostic. Give this number to the software department.

11. Trade Terms and Abbreviations

Term	Abbreviation	Description
Satellite supported position signals	GPS	24 earth circling satellites send GEO-positioned signals to earth bound receivers.
Accuracy		Accuracy of a certain position which can be relocated within 24 hours.
Correction signal	DGPS	A correction signal which corrects inaccuracies like time deviation, ion spherical tensions or GPS system malfunctions.
Wide Area Augmentation System	WAAS	Correction signal US Gov.
European Geo-Stationary Navigation Overlay System	EGNOS	Correction signal for Europe and West Russia.
Beacon		Low cost correction signal. Check availability.
Omnistar		Low cost correction signal. Check availability.
Real Time Kinematics Correction Signal	RTK	Correction signal available through a base station.
Baud		Transmission speed.
National Marine Electronics Association	NMEA 0183	NMEA 0183 is a standard protocol used by GPS receivers to transmit data.
Recommended Minimum Specific Global Navigation Satellite Support Data	GPRMC	Part of the NMEA 0183 protocol.
Global Positioning System Fit Data	GPGGA	Part of the NMEA 0183 protocol.
Parameter		Fixed value
Port		Serial interface
CAN BUS		data bus
Slip		Ratio of the speed of a driven wheel to that of a non-driven co-rotating wheel.

PSR Sonic

Select drive mode

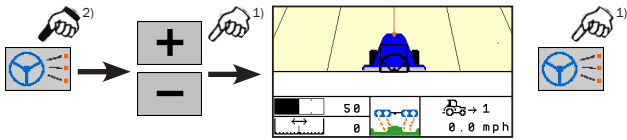

Set sample spacing

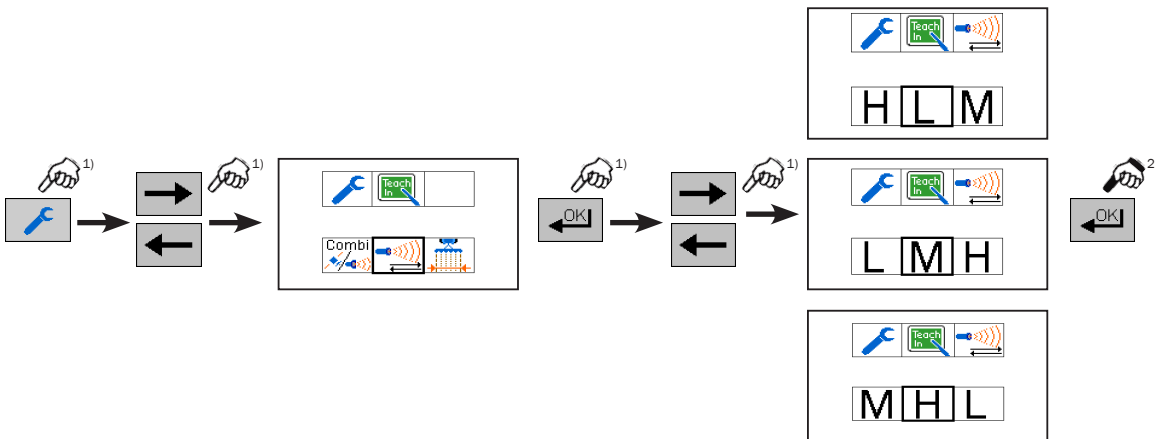

Switching PSR SONIC - PSR SKY on and off

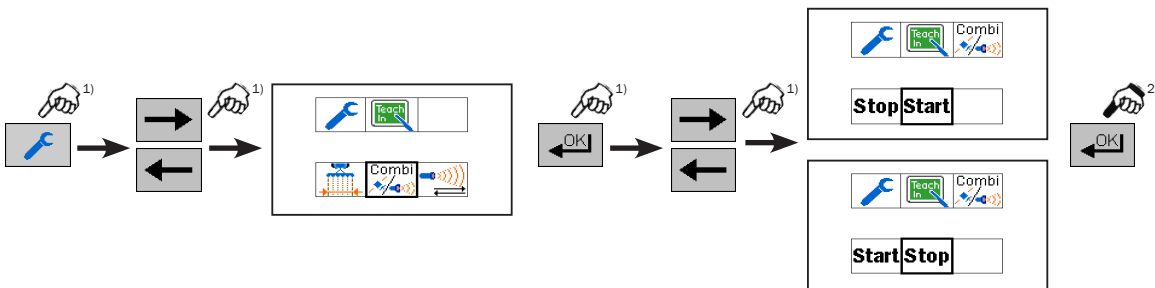

Set working width

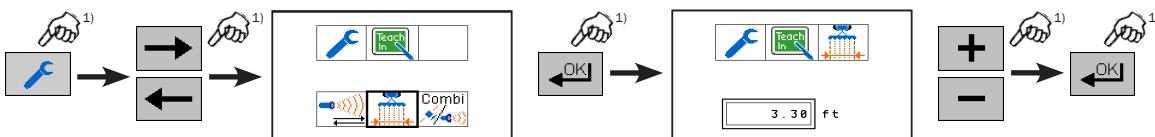

Let's stay on track

Legend: Press briefly Press and hold, until there is reaction.



Attention! Read and observe the manual and safety instructions prior to operation.

PSR SKY

Select drive mode

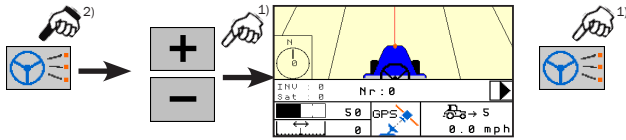

Set A-B / A+

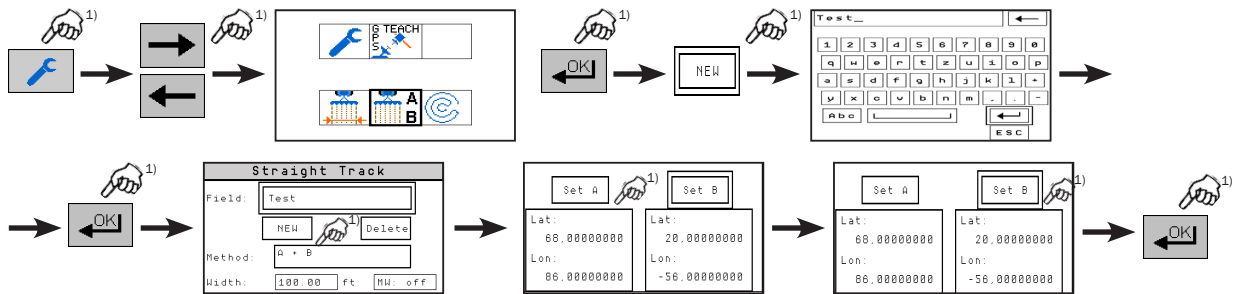

Set circles

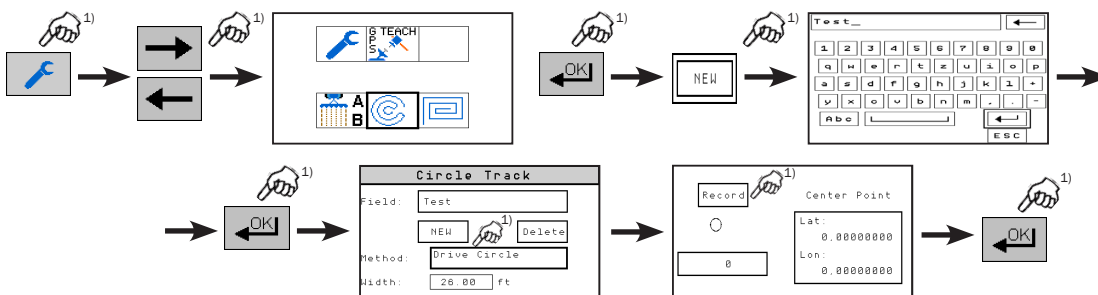

Set implement offset

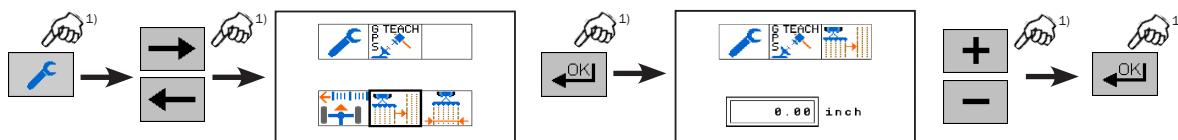

Calibrate reference line

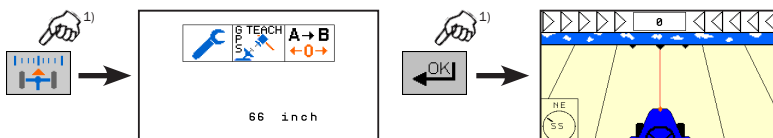

Let's stay on track

Legend:  Press briefly  Press and hold, until there is reaction.



Attention! Read and observe the manual and safety instructions prior to operation.

PSR SKY

Set multi-line

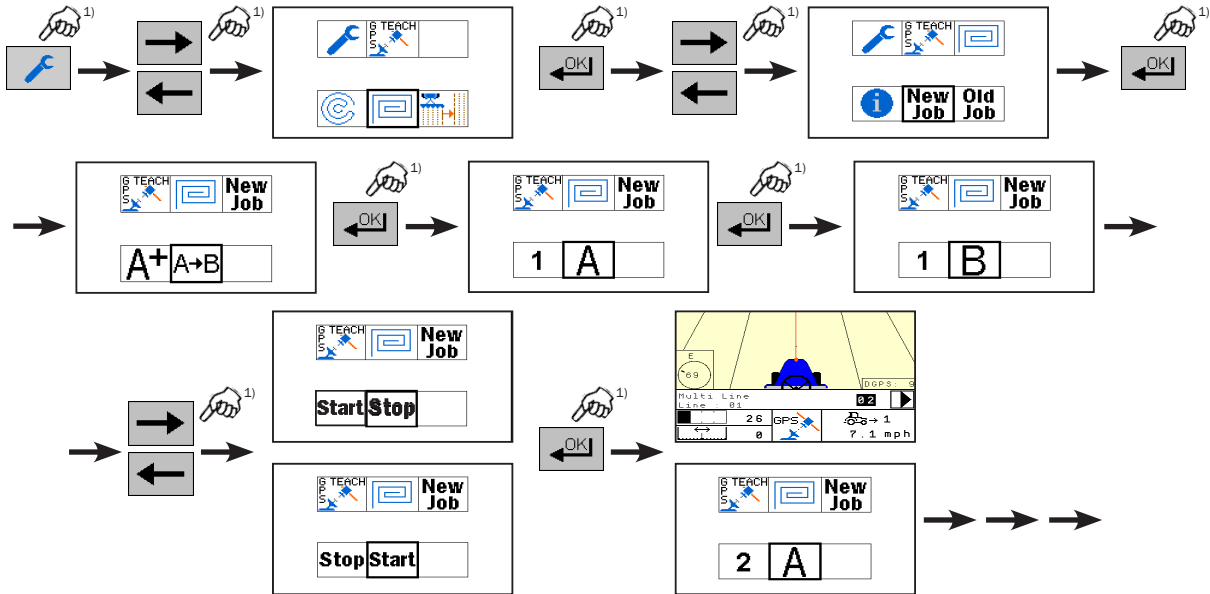

Set working width multi-line

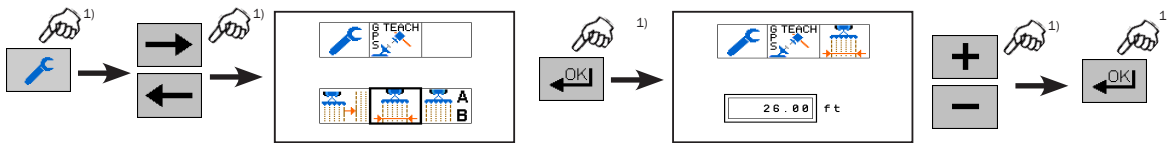

Select stored multi-line

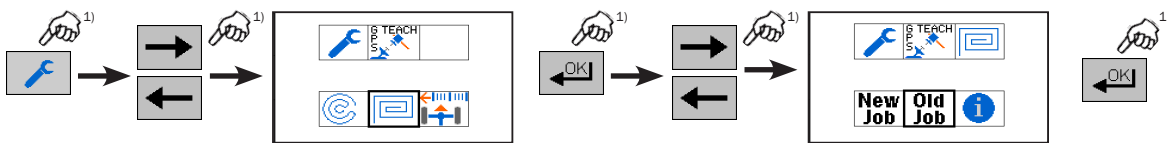

Let's stay on track

Legend: Press briefly Press and hold, until there is reaction.



Attention! Read and observe the manual and safety instructions prior to operation.

PSR TAC

Select drive mode

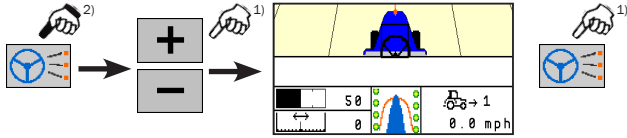

Calibrate TAC sensor

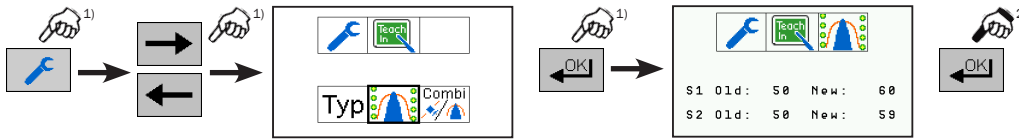

Switching coupling PSR TAC - PSR SKY on and off

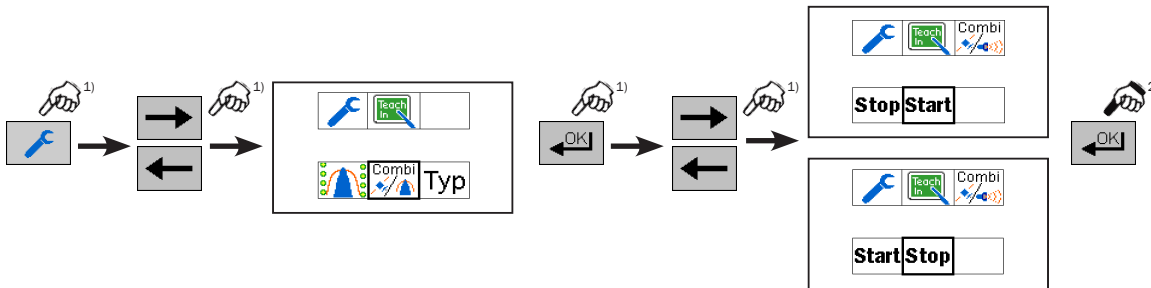

Select TAC sensor

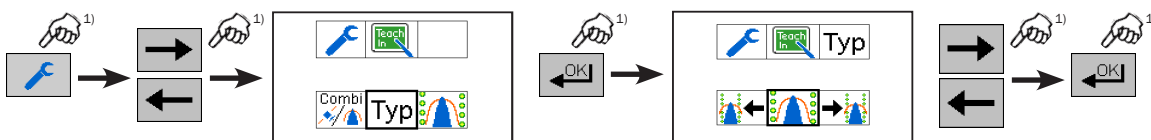

Let's stay on track

Legend:  Press briefly  Press and hold, until there is reaction.



Attention! Read and observe the manual and safety instructions prior to operation.